

**OPEN ACCESS**

## Volume III. DUNE far detector technical coordination

To cite this article: B. Abi *et al* 2020 *JINST* **15** T08009

View the [article online](#) for updates and enhancements.

### You may also like

- [Volume IV. The DUNE far detector single-phase technology](#)  
B. Abi, R. Acciarri, M.A. Acero *et al*.
- [Beam-induced and cosmic-ray backgrounds observed in the ATLAS detector during the LHC 2012 proton-proton running period](#)  
G. Aad, B. Abbott, J. Abdallah *et al*.
- [Comparison between simulated and observed LHC beam backgrounds in the ATLAS experiment at  \$E\_{\text{beam}} = 4\$  TeV](#)  
M. Aaboud, G. Aad, B. Abbott *et al*.



**IOP | ebooks™**

Bringing together innovative digital publishing with leading authors from the global scientific community.

Start exploring the collection—download the first chapter of every title for free.

# Deep Underground Neutrino Experiment (DUNE) Far detector technical design report

## Volume III DUNE far detector technical coordination

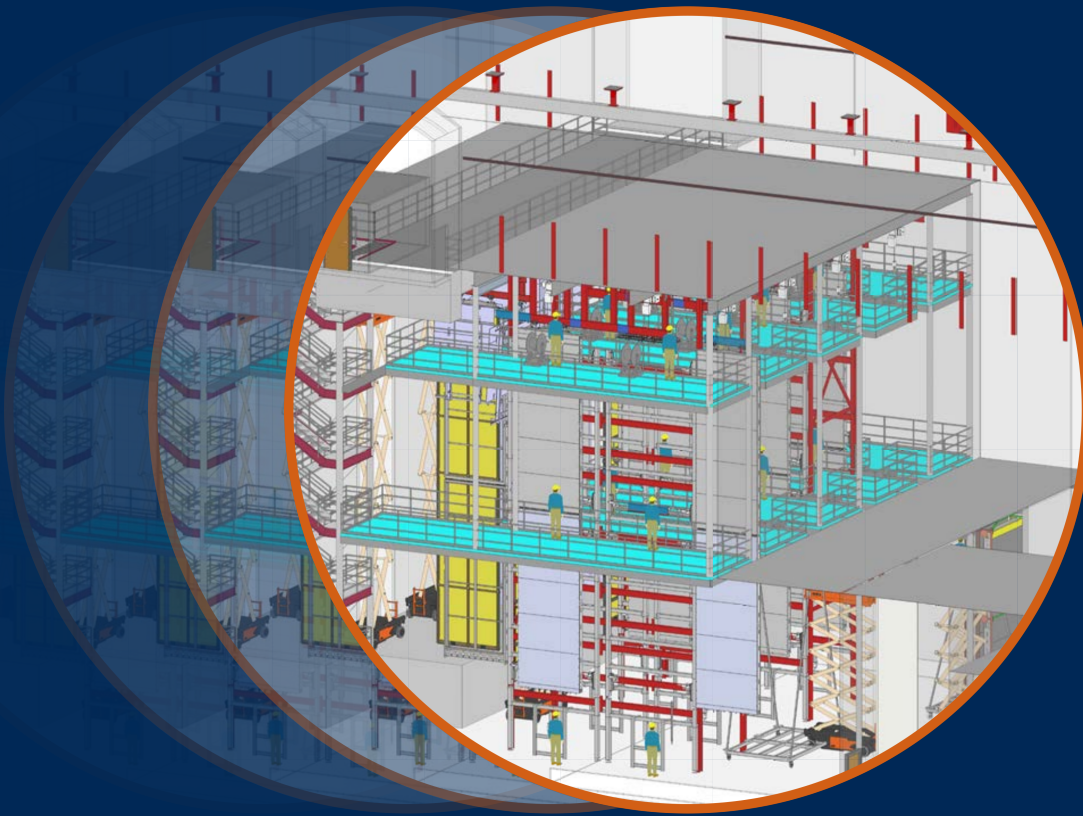

The DUNE collaboration

**DUNE**  
DEEP UNDERGROUND  
NEUTRINO EXPERIMENT



# Contents

<b>Contents</b>	<b>i</b>
<b>List of Figures</b>	<b>v</b>
<b>List of Tables</b>	<b>vii</b>
<b>A roadmap of the DUNE technical design report</b>	<b>1</b>
<b>1 Executive summary</b>	<b>2</b>
<b>2 Global project organization</b>	<b>4</b>
2.1 Global project partners	4
2.2 Experimental Facilities Interface Group	5
2.3 Joint Project Office	5
2.4 Coordinated global project functions	6
2.4.1 Safety	7
2.4.2 Engineering integration	7
2.4.3 Change control and document management	8
2.4.4 Scheduling	9
2.4.5 Review planning and oversight	9
2.4.6 Development of partner agreements	9
2.5 ProtoDUNE experience	10
<b>3 Detector design and construction organization</b>	<b>11</b>
3.1 DUNE consortia	11
3.2 DUNE collaboration management	12
3.3 Technical coordination	12
3.4 Technical coordination organization	14
3.4.1 Safety	15
3.4.2 Engineering integration	16
3.4.3 Change control and document management	17
3.4.4 Schedule	17
3.4.5 Risk management	18
3.4.6 Review process	18
3.5 DUNE work flow	18

2020 JINST 15 T08009

<b>4</b>	<b>Detector installation and commissioning organization</b>	<b>21</b>
4.1	Far site safety	21
4.2	Integration office management	23
4.2.1	South Dakota Warehouse Facility	24
4.2.2	Underground caverns	25
4.2.3	Trial assembly at Ash River	28
4.3	South Dakota Services Division	31
<b>5</b>	<b>Facility description</b>	<b>32</b>
5.1	Underground facilities and infrastructure	32
5.2	Detector caverns	33
5.3	Cryostat	36
5.4	Cryogenics	37
5.5	Detector and cavern integration	40
5.6	Detector grounding	40
5.7	Detector power	44
5.8	Data fibers	47
5.9	Central Utility Cavern Control and DAQ Rooms	48
5.10	Surface rooms	50
5.11	DUNE detector safety system	50
<b>6</b>	<b>DUNE detector construction management</b>	<b>54</b>
6.1	DUNE single-phase far detector module	54
6.2	DUNE dual-phase far detector module	55
6.3	DUNE far detector consortia	56
6.4	Work Breakdown Structure (WBS)	57
6.5	DUNE design maturity	58
<b>7</b>	<b>Integration engineering</b>	<b>61</b>
7.1	Mechanical integration models	61
7.1.1	Static models	62
7.1.2	Envelope and assembly models	63
7.1.3	Integration and interface drawings	65
7.1.4	Detector survey and alignment	67
7.2	Electrical integration	71
7.2.1	Electrical system block drawings, schematics, layouts and wiring diagrams	71
7.2.2	Electrical integration documentation	72
7.3	Configuration and drawing storage and dissemination	73
7.4	Organization of interfaces and interface documents	74
7.5	Engineering change control	76
7.6	Value engineering	77
<b>8</b>	<b>Reviews</b>	<b>78</b>
8.1	Design reviews	79
8.2	Production reviews	80
8.3	Installation reviews	80
8.4	Operations reviews	80
8.5	Review tracking	80

8.6	Lessons learned	80
8.7	Reporting	81
<b>9</b>	<b>Quality assurance</b>	<b>82</b>
9.1	Overview of DUNE quality assurance	82
9.1.1	Purpose	82
9.1.2	Scope	83
9.1.3	Graded approach	83
9.2	Quality assurance program	83
9.2.1	Responsibility for project management	84
9.2.2	Levels of authority and interface	85
9.2.3	Quality assurance organization	85
9.3	Personnel training and qualification	86
9.4	Quality improvement and lessons learned	86
9.5	Documents and records	88
9.6	Work processes	88
9.6.1	Fabrication work processes	88
9.6.2	Change-controlled work processes	89
9.7	Design	89
9.7.1	Design process	89
9.7.2	Design verification and validation	91
9.8	Procurement	92
9.8.1	Procurement controls	92
9.8.2	Inspection and acceptance testing	93
9.9	Assessments	93
9.9.1	Management assessments	93
9.9.2	Independent assessments	94
9.10	DUNE quality control	94
9.10.1	APA quality control	95
9.10.2	HV quality control	96
9.10.3	TPC electronics quality control	96
9.10.4	PD quality control	97
9.10.5	Calibration quality control	98
9.10.6	DAQ quality control	99
9.10.7	CISC quality control	100
9.11	ProtoDUNE to DUNE QA approach	100
<b>10</b>	<b>Environment, safety, and health</b>	<b>102</b>
10.1	LBNF/DUNE ES&H management and oversight	103
10.2	National Environmental Protection Act compliance	103
10.3	Codes/standards equivalencies	103
10.4	ES&H requirements at collaborating laboratories and institutions	104
10.5	LBNF/DUNE ES&H program at SURF	104
10.5.1	Site and facility access	104
10.5.2	ES&H training	104
10.5.3	Personnel protective equipment	105
10.5.4	Work planning and controls	105
10.5.5	Emergency management	106

10.5.6	Fire protection, ODH and life safety	107
10.5.7	Earthquake design standards	108
10.5.8	Material handling and equipment operation	108
10.5.9	Stop work authority	108
10.5.10	Operational readiness	109
10.5.11	Lessons learned	109
<b>A</b>	<b>Project document summary</b>	<b>110</b>
A.1	Interface documents	110
A.2	Schedule milestones	111
A.3	Requirements	111
A.4	Full DUNE requirements	115
A.4.1	Single-phase	115
A.4.2	Dual-phase	128
A.5	Risks	139
A.6	Full DUNE risks	141
A.6.1	Single-phase	141
A.6.2	Dual-phase	149
A.7	Hazard Analysis Report (HAR)	155
A.7.1	Construction hazards (LBNF-DUNE HA-1)	157
A.7.2	Natural phenomena (LBNF-DUNE HA-2)	158
A.7.3	Environmental hazards (LBNF-DUNE HA-3)	158
A.7.4	Waste hazards (LBNF-DUNE HA-4)	158
A.7.5	Fire hazards (LBNF-DUNE HA-5)	158
A.7.6	Electrical hazards (LBNF-DUNE HA-6)	159
A.7.7	Noise/vibration/thermal/mechanical (LBNF-DUNE HA-7)	160
A.7.8	Cryogenic/oxygen deficiency hazard (LBNF-DUNE HA-8)	160
A.7.9	Confined space hazards (LBNF-DUNE HA-9)	161
A.7.10	Chemical/hazardous materials hazards (LBNF-DUNE HA-11)	161
A.7.11	Lasers & other non-ionizing radiation hazards (LBNF-DUNE HA-14)	162
A.7.12	Material handling hazards (LBNF-DUNE HA-15)	162
A.7.13	Experimental operations (LBNF-DUNE HA-16)	162
	<b>Acknowledgments</b>	<b>163</b>
	<b>Glossary</b>	<b>164</b>
	<b>Bibliography</b>	<b>173</b>
	<b>The DUNE collaboration</b>	<b>178</b>

# List of Figures

2.1	Global project organization	4
2.2	JPO functions	6
2.3	LBNF/DUNE ES&H	7
3.1	DUNE internal consortium structure	12
3.2	DUNE org chart	13
3.3	DUNE technical coordination org chart	15
3.4	DUNE construction ES&H	16
4.1	DUNE installation ES&H	22
4.2	Integration office installation team org chart	23
4.3	Underground summary schedule	25
4.4	Common technical resources	26
4.5	Underground detector installation team	27
4.6	Phase 1 APA installation frame being installed on the APA assembly tower at Ash River	29
4.7	Phase 2 trial assembly at Ash River	30
5.1	Underground campus	32
5.2	DUNE cryostat	34
5.3	Underground fire zones	35
5.4	DUNE cryostat	36
5.5	Cryogenics system	39
5.6	North elevation view of detector	40
5.7	West elevation view of detector	41
5.8	Elevation view of top of cryostat	42
5.9	Overall DUNE grounding structure	42
5.10	Simplified detector grounding	44
5.11	Detector grounding schematic	45
5.12	DUNE estimated power consumption.	46
5.13	Detector fiber path	47
5.14	DAQ and control room in CUC	48
5.15	DAQ and control room	49
5.16	DAQ room layout	50
5.17	Surface rooms layout	51
5.18	Examples of DUNE detector safety system information flow	52
6.1	A 10 kt SP module.	55

## List of Figures

---

6.2	A 10 kt DP module	56
6.3	DUNE consortia	57
6.4	DUNE WBS at level 2	58
7.1	Overall model of the SP module	62
7.2	Model of one row of the SP module	63
7.3	Section view of the SP module in the transverse direction	64
7.4	Overall model of the SP module in the longitudinal direction	64
7.5	Interface between upper APA, FC, cable trays and DSS	65
7.6	Interface between lower APA, FC and service floor	66
7.7	Interface between APA, upper FC and GP	67
7.8	Interface between CPA, upper FC and GP	68
7.9	Envelope dimensions and installation clearances for APAs and CPAs (warm)	68
7.10	APAs active area gap in cold state	69
7.11	SP module interface of cryogenics, service floor and detector	69
7.12	Position of longitudinal reference point for the SP module	70
7.13	Sample system-level block diagram	72
7.14	EDMS file structure	74
7.15	Integration nodes	75
8.1	DUNE review process	78
9.1	Fermilab QA	82
9.2	DUNE QA organization	84
9.3	LBNF/DUNE change control	90

2020 JINST 15 T08009



# List of Tables

3.1	DUNE responsibility matrix	19
3.2	DUNE decision-making matrix	20
6.1	DUNE-SP design maturity at the time of ProtoDUNE and at the time of the TDR	59
A.1	SP module inter-consortium interface document matrix	110
A.2	SP module consortium-TC interface document matrix	111
A.3	DUNE schedule milestones	112
A.4	DUNE physics-related specifications owned by EB	113
A.5	DUNE high-level system specifications owned by the EB	114
A.6	Specifications for SP-FD.	115
A.7	APA specifications.	117
A.8	HV specifications.	118
A.9	TPC electronics specifications.	118
A.10	PDS specifications.	120
A.11	Calibration specifications.	122
A.12	DAQ specifications.	124
A.13	CISC specifications.	126
A.14	Installation specifications.	127
A.15	Specifications for DP-FD.	128
A.16	DP CRP specifications.	131
A.17	DP HV specifications.	132
A.18	DP TPC electronics specifications.	132
A.19	DP PDS specifications.	133
A.20	DP calibration specifications.	134
A.21	DP DAQ specifications.	136
A.22	DP CISC specifications.	138
A.23	APA risks	141
A.24	HV risks	142
A.25	TPC electronics risks	143
A.26	PD system risks	144
A.27	Calibration risks	145
A.28	DAQ risks	146
A.29	CISC risks	147
A.30	SP module installation risks	148
A.31	DP CRP Risks	149
A.32	DP HV risks	149

## List of Tables

---

A.33 DP TPC electronics risks	150
A.34 DP PDS risks	151
A.35 DP calibration risks	152
A.36 DP DAQ Risks	152
A.37 DP CISC risks	153
A.38 DP module installation risks	155
A.39 List of identified hazards	156

2020 JINST 15 T08009

# A roadmap of the DUNE technical design report

The Deep Underground Neutrino Experiment (DUNE) far detector (FD) technical design report (TDR) describes the proposed physics program, detector designs, and management structures and procedures at the technical design stage.

The TDR is composed of five volumes, as follows:

- Volume I (Introduction to DUNE) provides an overview of all of DUNE for science policy professionals.
- Volume II (DUNE physics) describes the DUNE physics program.
- Volume III (DUNE far detector technical coordination) outlines DUNE management structures, methodologies, procedures, requirements, and risks.
- Volume IV (The DUNE far detector single-phase technology) and Volume V (The DUNE Far Detector Dual-Phase Technology) describe the two FD liquid argon time-projection chamber (LArTPC) technologies.

The text includes terms that hyperlink to definitions in a volume-specific glossary. These terms appear underlined in some online browsers, if enabled in the browser's settings.

# Chapter 1

## Executive summary

This volume describes how the activities required to design, construct, fabricate, install, and commission the DUNE FD modules are organized and managed. The FD modules are hosted at the Long-Baseline Neutrino Facility (LBNF) site at the Sanford Underground Research Facility (SURF). The DUNE FD construction project is one piece of the global LBNF and DUNE project (LBNF/DUNE), which encompasses all of the facilities, supporting infrastructure, and detector elements required to carry out the DUNE science program at SURF.

The DUNE collaboration has responsibility for the design and construction of the DUNE detectors. Groups of collaboration institutions, referred to as consortia, assume responsibility for the different detector subsystems. The activities of the consortia are overseen and coordinated through the DUNE technical coordination organization headed by the DUNE technical coordinator (TC). The technical coordination organization provides project support functions such as safety coordination, engineering integration, change control, document management, scheduling, risk management, and technical review planning. DUNE technical coordination manages internal, subsystem-to-subsystem interfaces, and is responsible for ensuring the proper integration of the different subsystems.

A Joint Project Office (JPO) establishes the global engineering and documentation requirements adhered to within the DUNE FD construction project, manages external DUNE detector interfaces with LBNF, and is responsible for ensuring proper integration of the DUNE detector elements within the facilities and supporting infrastructure. DUNE technical coordination works closely with the support teams of its LBNF/DUNE partners within the framework of the JPO to ensure coherence in project support functions across the entire global enterprise. To ensure consistency of the DUNE environment, safety and health (ES&H) and quality assurance (QA) programs with those across LBNF/DUNE, the LBNF/DUNE ES&H and QA managers, who sit within the JPO, are embedded within the DUNE technical coordination organization.

The LBNF/DUNE integration office under the direction of the project integration director incorporates the on site team responsible for coordinating integration and installation activities at SURF. Detector integration and installation activities are supported by the DUNE consortia, which maintain responsibility for ensuring proper installation and commissioning of their subsystems. External DUNE interfaces with the on site integration and installation activities are managed through the JPO. Support services are provided by the Fermilab South Dakota Services Division (SDSD) and SURF.

The ordering of the subsequent chapters is chosen to provide first, additional detail regarding the organizational structures summarized here; second, overviews of the facilities, supporting infrastructure, and detectors for context; and third, information on project-related functions and methodologies used by DUNE TC focusing on the areas of integration engineering, technical reviews, QA, and safety oversight. Because of their more advanced stage of development, functional examples presented here focus primarily on the single-phase (SP) detector module.

## Chapter 2

# Global project organization

### 2.1 Global project partners

The LBNF project is responsible for providing both the conventional facilities (CF) and supporting infrastructure (cryostats and cryogenics systems) that house the DUNE FD modules. LBNF is a U.S. DOE project incorporating contributions from international partners and is headed by the LBNF project director who also serves as the Fermi National Accelerator Laboratory (Fermilab) deputy director for LBNF. The international DUNE collaboration under the direction of its management team is responsible for the detector components. The DUNE FD construction project encompasses all activities required for designing and fabricating the detector elements and incorporates contributions from a number of international partners. The organization of the global LBNF/DUNE, which encompasses both project elements, is shown in figure 2.1.

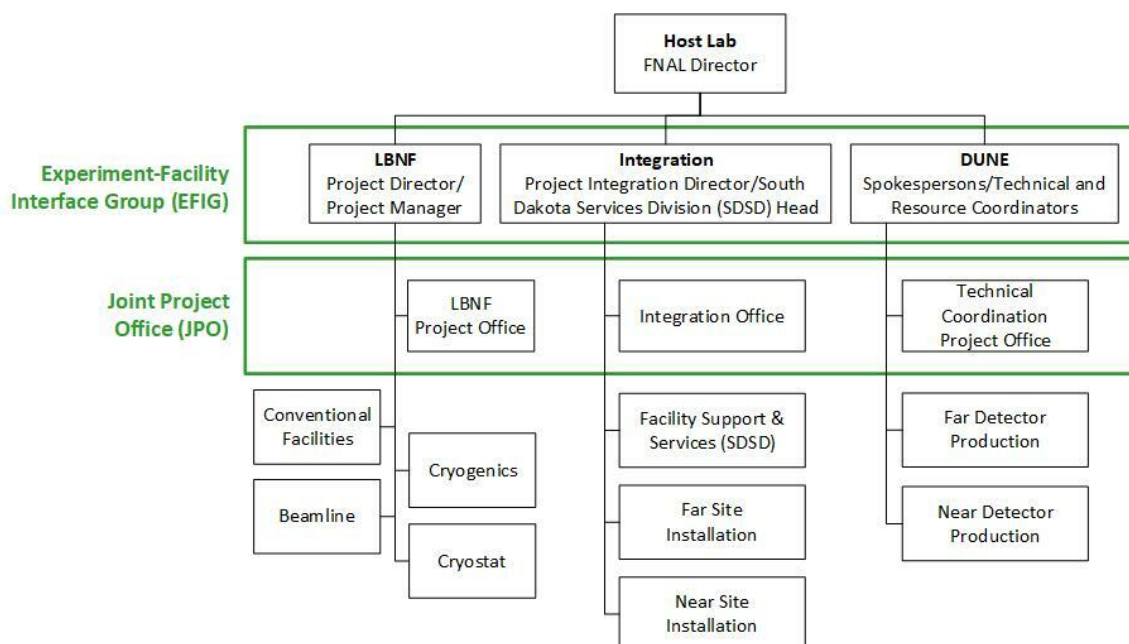

**Figure 2.1.** LBNF/DUNE organization.

In addition to the LBNF and DUNE pieces, the overall coordination of installation activities in the underground caverns is managed as a separate element of LBNF/DUNE under the responsibility of the project integration director, who is appointed by and reports to the Fermilab director. To ensure coordination across all elements of LBNF/DUNE, the project integration director connects to both the facilities and detector construction projects through ex-officio positions on the LBNF Project Management Board and DUNE executive board (EB), respectively. In carrying out these responsibilities, the project integration director receives support from the SDSD, a Fermilab division established to provide the necessary supporting infrastructure for installation, commissioning, and operation of the DUNE detector.

The project integration director works closely with the LBNF and DUNE teams in advance of these activities to coordinate planning and ensure that detector elements are properly integrated within the supporting infrastructure. Although the project integration director is responsible for overall coordination of installation activities at SURF, the DUNE consortia maintain responsibility for the installation and commissioning of their detector subsystems and support these activities by providing dedicated personnel and equipment resources. Likewise, LBNF retains responsibility for the installation and commissioning of supporting infrastructure items and provides dedicated resources to support these activities.

### **2.2 Experimental Facilities Interface Group**

The Experimental Facilities Interface Group (EFIG) is the body responsible for the required high-level coordination between the LBNF and DUNE construction projects. The LBNF project director and project integration director co-chair the EFIG. EFIG leadership also incorporates the four members of the DUNE collaboration management team (co-spokespersons, TC, and resource coordinator (RC)). The EFIG is responsible for steering the integration and installation of the LBNF/DUNE deliverables and operates via the consensus of its leadership team. If issues arise for which consensus cannot be achieved, decision-making responsibility is passed to the Fermilab director.

### **2.3 Joint Project Office**

The EFIG is augmented by a JPO that supports both the LBNF and DUNE projects as well as the integration effort that connects the two together. The JPO combines project support functions that exist within the different elements of the global project to ensure proper coordination across the entire LBNF/DUNE enterprise. Project functions coordinated globally through the JPO are shown in figure 2.2 along with the personnel currently supporting those functions. The team members who support these functions within the JPO framework are drawn from the LBNF project office, DUNE technical coordination, and LBNF/DUNE integration office personnel.

Team members focusing on specific project activities and functions within the JPO are typically those carrying equivalent responsibilities within their home organization. For example, the JPO team responsible for building the fully integrated 3D CAD model of the detector within its supporting infrastructure and surrounding facility includes the members of the LBNF and DUNE project teams responsible for integrating the individual elements.

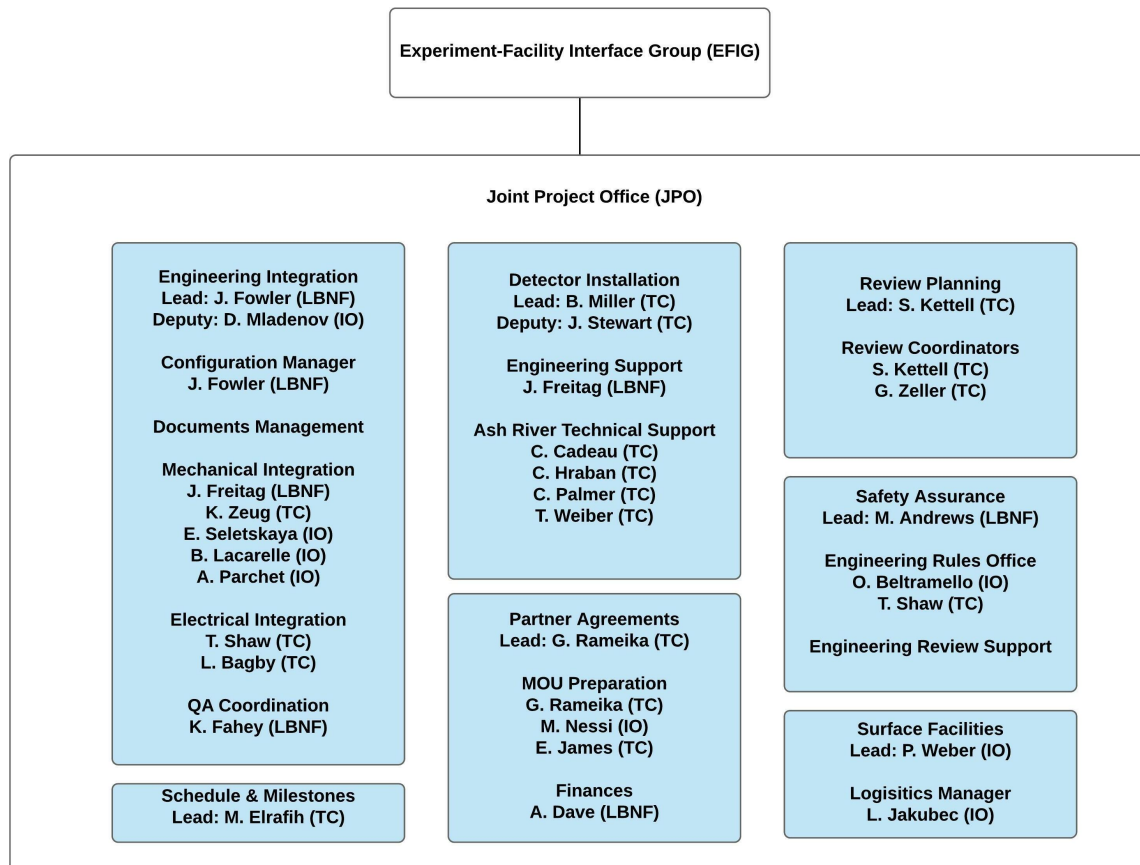

Figure 2.2. JPO global support functions and teams.

## 2.4 Coordinated global project functions

Project support functions requiring JPO coordination include safety, engineering integration, change control and document management, scheduling, review planning and oversight, and development of partner agreements. Additional detail is provided in the subsequent sections regarding the JPO role in coordinating these support functions.

Planning activities related to detector installation and the provision of surface facilities are also currently embedded within the framework of the JPO to ensure that all project elements are properly incorporated. At the time when LBNF far site conventional facilities (FSCF) delivers acceptance for use and possession (AUP) of the underground detector caverns at SURF, the coordination of onsite activities associated with detector installation and the operation of surface facilities will be fully embedded within the LBNF/DUNE integration office under the direction of the project integration director. Some current members of the LBNF project office and DUNE technical coordination are expected to be moved into the integration office at that point in time. The integration office team required to coordinate post-excavation activities at SURF is described in chapter 4.



### 2.4.1 Safety

To ensure a consistent approach to safety across LBNF/DUNE, there is a single LBNF/DUNE ES&H manager who reports to the LBNF project director, project integration director, and DUNE management (via the DUNE TC). This individual directs separate safety teams responsible for implementing the LBNF/DUNE ES&H program within both the LBNF and DUNE projects as well as the LBNF/DUNE installation activities at SURF. The safety organization is shown in figure 2.3 and is described further in sections 3.4.1 and 4.1 and in chapter 10.

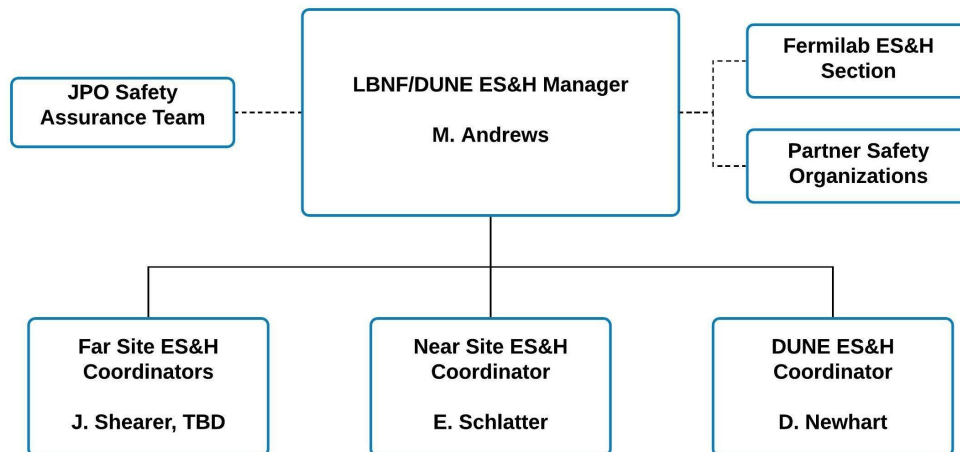

Figure 2.3. High level LBNF/DUNE ES&H organization.

The LBNF/DUNE ES&H manager works with the Fermilab and SURF safety organizations to ensure that all project-related activities comply with the rules and regulations of the host organizations. For example, the LBNF/DUNE ES&H manager works with the host safety organizations to develop the rules and regulations governing work in the underground areas at SURF, which are then consistently applied across all underground project activities.

The JPO engineering safety assurance team defines a common set of design and construction rules (mechanical and electrical) to ensure consistent application of engineering standards and engineering documentation requirements across LBNF/DUNE. This team works with the LBNF/DUNE ES&H manager to develop equivalencies in codes and standards across the international project as needed. Following on lessons learned from the processes used for the ProtoDUNE detectors, an important mandate of the engineering safety assurance team is to ensure that safety issues related to component handling and installation are incorporated within the earliest stages of the design review process. The JPO team incorporates engineering resources to perform independent validation of required mechanical analyses that ensure the structural integrity of detector components through all stages of construction, installation, and operation.

### 2.4.2 Engineering integration

A central JPO engineering team is responsible for building an integrated model of the detectors within their supporting infrastructure and the FSCF that house them. The team builds and maintains a full 3D CAD model of everything in the underground detector caverns from the models of the individual components provided by the LBNF and DUNE design teams. Starting from the latest,

approved version of the full CAD model, the JPO team incorporates approved changes as they are received and checks to ensure that no errors or space conflicts are introduced into the model. As part of this process, 2D control drawings are produced from the 3D CAD model to validate adherence with critical component-to-component clearances within the integrated model. The updated working model is passed back to the individual LBNF and DUNE design teams to validate that their design modifications have been properly incorporated within the global model. After receiving the appropriate sign-offs from all parties, the JPO team tags a new frozen release of the model and makes it available to the design teams as the current release against which the next set of design changes will be generated.

Electrical engineers are incorporated within the central JPO team to ensure proper integration of the detector electrical components. This team is responsible for ensuring that detector grounding and shielding requirements, the maintenance of which are critical for detector performance, are strictly adhered to. The team oversees the layout of electronics racks and cable trays both on the top of the cryostats and within the central utility cavern (CUC) counting room that hosts the data acquisition (DAQ) electronics. It also oversees the design of the power and cooling distribution systems that are required to support the electronics infrastructure.

The JPO engineering team is responsible for documenting and controlling the interfaces between the LBNF and DUNE projects as well as the interfaces between these projects and the LBNF/DUNE installation activities at SURF. To define these interfaces, the JPO team develops formal documents which, subsequent to the approval of the relevant managers, are placed under signature and versioning control. These documents are monitored regularly to ensure that no missing scope or technical incompatibilities are introduced at the boundaries between the project elements.

### 2.4.3 Change control and document management

The LBNF/DUNE project partners have agreed to adopt the formal change control process developed previously for the LBNF project. The change control process applies to proposed modifications of requirements, technical designs, schedule, overall project scope, and assigned responsibilities for individual scope items. The formal LBNF/DUNE change control process is described in DocDB 82 [1]. The process includes separate decision paths for items affecting only DUNE or LBNF and incorporates an additional pathway for items affecting both projects. A hierarchy of decision-making layers is built into each pathway based on pre-determined thresholds related to the extent of the proposed change. The lowest-level change control body for modifications affecting both LBNF and DUNE is the EFIG. The JPO incorporates a configuration manager within the engineering integration team who is responsible for formally implementing changes that are approved through this process. After technical changes are incorporated into the global 3D CAD models, the engineering integration team is responsible for checking production drawings and verifying that no potential space conflicts have been introduced. Under the direction of the configuration manager, all project changes are documented in detail and approved by the appropriate project partners using the LBNF change control tool.

The configuration manager oversees a document management team responsible for administering and managing the LBNF/DUNE document management system, which is hosted in the engineering document management system (EDMS). All technical documents and drawings are stored in the EDMS system under formal signature and versioning control. A product breakdown

structure (PBS) database will be maintained to track the history of each detector component (and supporting infrastructure item) through construction, assembly, testing, transport, and installation. The LBNF/DUNE QA manager is embedded within the JPO engineering integration team as the QA coordinator and has responsibility for ensuring that all necessary documents and testing results used to validate component quality are stored within the PBS database.

### 2.4.4 Scheduling

The JPO team is responsible for creating a single project schedule for LBNF/DUNE that incorporates all LBNF and DUNE activities together with the installation activities at SURF, incorporating all interdependencies. A brief discussion is provided in section A.2. This schedule will be used to track the status of the global enterprise. The project partners have agreed that the LBNF/DUNE schedule will be managed within the same Primavera P6 framework used to plan and set the status of the resource-loaded schedule of activities required for DOE contributions to LBNF and DUNE. Activities falling under the responsibility of other international partners are included and linked within the P6 schedule but do not incorporate associated resource information required for DOE activities. Non-DOE activities will not be tracked using the formal earned value management system (EVMS) procedures required for the DOE project activities, but rather through regular assessments of progress towards completion by the management teams responsible for those activities. A substantial number of milestones will be embedded within the schedule at an appropriate level of granularity to allow for high-level tracking of the project progress towards its completion.

### 2.4.5 Review planning and oversight

As described in chapter 8, all reviews conducted across the LBNF/DUNE enterprise are coordinated through the JPO review planning team to ensure coherence in the review process. DUNE collaboration management via the TC has responsibility for design (preliminary design review and final design review) and production (production readiness review and production progress review) reviews focusing on the different detector elements. Similarly, LBNF project management has responsibility for design and production reviews covering the supporting infrastructure pieces within its scope. Installation readiness reviews and operational readiness reviews, on the other hand, are the responsibility of the project integration director. Central coordination of the review process through the JPO review planning team ensures that issues related to installation and operation are incorporated within all stages of the review process. Safety issues related to handling and installation of components are addressed starting from the earliest design reviews — with the development of detailed engineering notes containing the required structural analysis — through installation and operations reviews with detailed hazard analyses. The JPO team also takes responsibility for tracking review recommendations and closing them as appropriate, based on resulting actions.

### 2.4.6 Development of partner agreements

Partner contributions to all project elements will be detailed in a series of written agreements. In the case of LBNF, these contributions will be spelled out in bilateral agreements between DOE and each of the contributing partners. In the case of DUNE, there will be a memorandum of understanding (MoU) detailing the contributions of all participating partners. The MoU will detail the deliverables

being provided by each partner and summarize required contributions to common items, for which the collaboration assumes shared responsibility. A series of more technical agreements describing the exact boundaries between partner contributions and the terms and conditions under which they will be delivered will lie just beneath the primary agreements. The JPO team focusing on partner agreements will coordinate the process for drafting written agreements and work to obtain the appropriate partner approvals on each.

### 2.5 ProtoDUNE experience

The global structure of LBNF/DUNE is based heavily on the organization that successfully executed the construction, installation, commissioning, and operation of the ProtoDUNE detectors at the European Organization for Nuclear Research (CERN). The onsite team at CERN responsible for the overall installation of detector and infrastructure components within the test beam facility played a critical role in the successful execution of the ProtoDUNE program. The separate projects responsible for the construction of the detector and infrastructure components interacted effectively with the central, onsite team to minimize the issues encountered during the installation and commissioning process. In cases where issues did arise, construction project team members interacted effectively with their counterparts on the onsite team to reach quick resolutions.

Some lessons learned from the ProtoDUNE experience have been applied in creating the LBNF/DUNE organization for the DUNE FD. The integration of installation safety issues into the early stages of the design review process is one such example. Delays were encountered in getting approvals for the installation of some ProtoDUNE-SP components stemming from the absence of a coordinated approach in the review process for these items. The creation of the JPO review planning team charged with organizing a coherent review process across LBNF/DUNE is meant to address this issue. In general, the successful implementation of the ProtoDUNE detectors demonstrates the capacity of the organizational structures to safely execute the project and meet performance requirements, as was seen in ProtoDUNE-SP.

The team that led the installation of ProtoDUNE at CERN also led the installation of MINOS in the Soudan mine in Minnesota, and that experience extrapolates to the upcoming installation at SURF. Fermilab established the SDSD to work with SURF to ensure that appropriate site infrastructure and support mechanisms needed to execute onsite project activities are in place.

## Chapter 3

# Detector design and construction organization

The DUNE FD construction project refers collectively to the activities associated with the design and construction of necessary detector components. DUNE collaboration management is responsible for overseeing this portion of the LBNF/DUNE and ensuring its successful execution. The high-level DUNE collaboration management team consisting of the co-spokespersons, TC, and RC is responsible for the management of the project.

### 3.1 DUNE consortia

Construction of the DUNE far detector modules is carried out by consortia of collaboration institutions who assume responsibility for detector subsystems. Each consortium plans and executes the construction, installation, and commissioning of its subsystem.

Management of each consortium is through an overall consortium leader and a technical lead. The consortium leader chairs an institutional board composed of one representative from each of the collaborating institutions contributing to the activities of the consortium. Major consortium decisions such as technology selections and assignment of responsibilities within the institutions should pass through its institutional board. These decisions are then passed as recommendations to the DUNE EB, as described in greater detail below, for formal collaboration approval.

Figure 3.1 shows an example consortium organizational chart incorporating the basic structures mandated by DUNE collaboration management. In addition to the pieces described above, consortia in most cases need to manage the design and construction of subsystem deliverables that are supported by multiple funding agencies. In the sample case illustrated here, responsibilities for subsystem deliverables are shared between the USA, UK, and Switzerland (CH), where each of the funding agencies is expected to manage its own internal projects with responsibility for different sets of assigned deliverables. To ensure coordination between the separate internal projects contributing to the consortia, technical leads are responsible for chairing consortium project management boards incorporating separate managers from each of the internal projects.

In addition to the mandated organizational pieces described here, the consortia incorporate additional internal structures as needed to deliver their assigned subsystems. For example, working

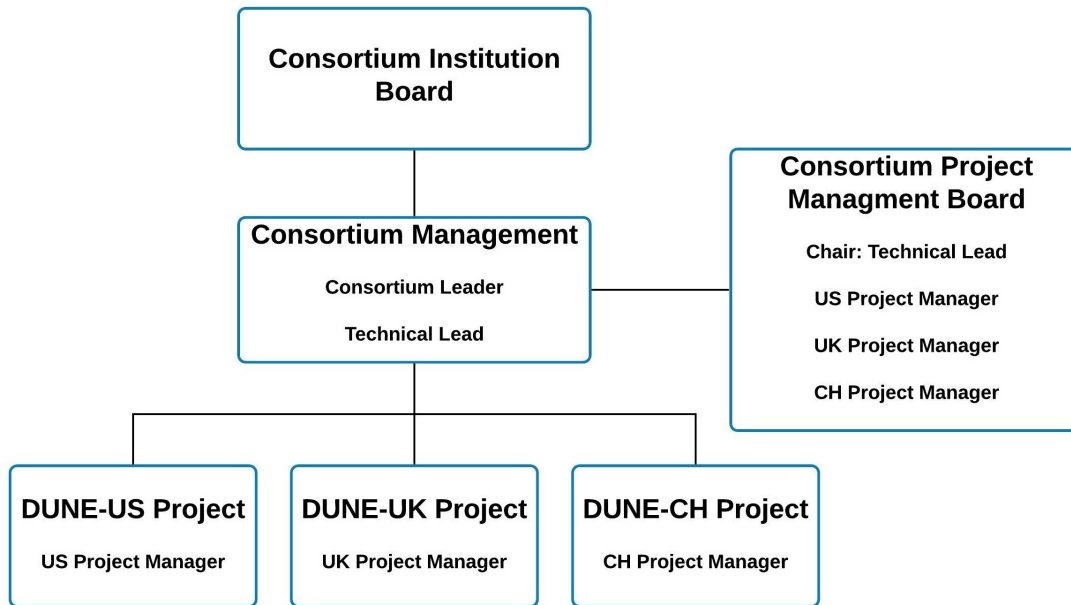

Figure 3.1. Sample DUNE internal consortium structure.

groups with convenors are typically appointed to focus on specific consortium activities, and steering committees are in many cases formed to help guide technical and strategic decisions within the consortia. Each consortium is also expected to appoint both safety and QA representatives as well as a representative with responsibility for integration and installation. These individuals are charged with interacting with the appropriate project support team personnel to ensure coordination in these areas across the consortia.

### 3.2 DUNE collaboration management

The high-level DUNE collaboration management structure is shown in figure 3.2. The DUNE EB is the primary collaboration decision-making body and as such includes representatives from all major areas of activity within the collaboration.

Each consortium is represented on the DUNE EB by its consortium leader. All collaboration decisions, especially those with potential impacts on the DUNE scientific program or connected with the assignment of institutional responsibilities, pass through the EB. EB decisions are made by consensus. In cases where consensus cannot be obtained, decision-making responsibility passes to the co-spokespersons.

### 3.3 Technical coordination

Because the consortia operate as self-managed entities, a strong technical coordination organization is required to ensure overall integration of the detector elements and successful execution of the detector construction project. Technical coordination areas of responsibility include general project oversight, systems engineering, QA, and safety. Technical coordination also supports the planning and execution of integration and installation activities at SURF (see chapter 4).

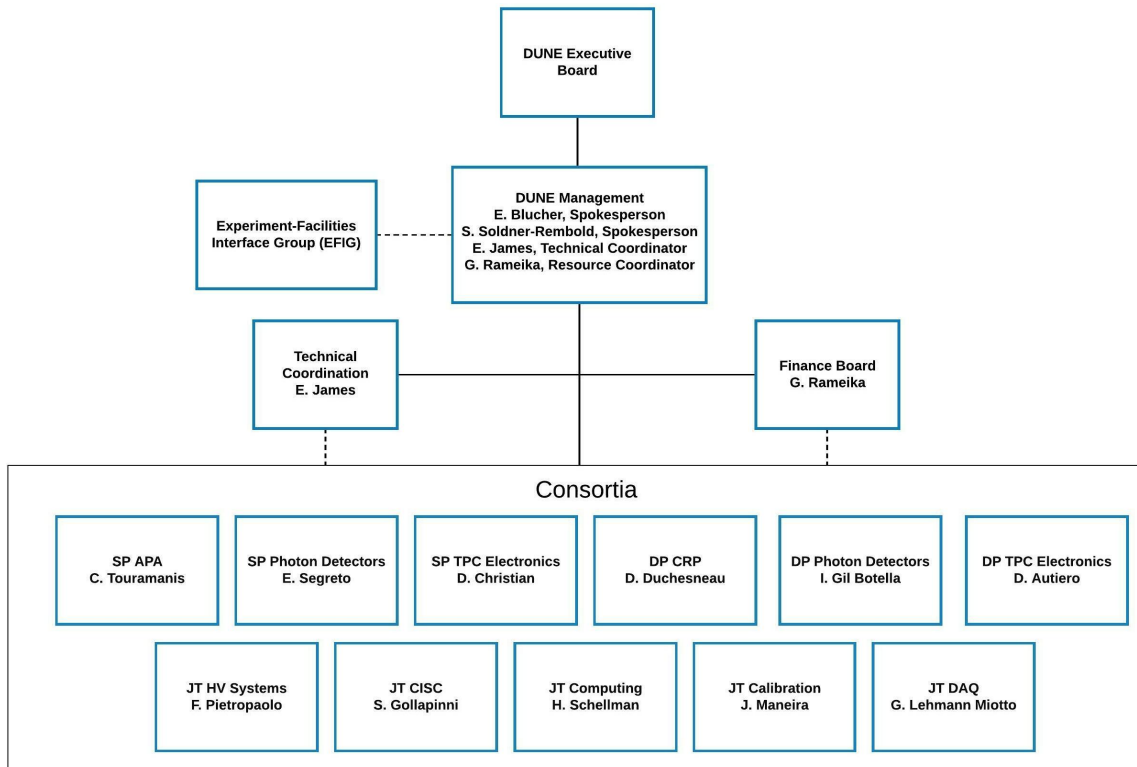

Figure 3.2. DUNE organizational chart.

Technical coordination is headed by the TC, a Fermilab employee appointed jointly by the Fermilab director and the DUNE co-spokespersons. A deputy TC selected from within the collaboration will assist the TC.

The TC manages the overall detector construction project through regular technical and project board meetings with the consortium leadership teams and members of the technical coordination organization (see section 3.4). These board meetings are used to identify and resolve issues and serve as the primary fora for required interactions between the consortia.

Technical board meetings are used to evaluate consortia design decisions with potential impacts on overall detector performance, ensure that interfaces between the different subsystems are well understood and documented, and monitor the overall construction project to identify and address both technical and interface issues as they arise.

Project board meetings are used to ensure that the scopes of each consortium are fully documented with assigned institutional responsibilities, develop and manage risks held within a global project registry, review and manage project change requests, and monitor the status of the overall detector construction schedule.

Any decisions generated through these board meetings are passed to the DUNE EB as recommendations for formal approval. Depending on the agenda items to be discussed at a specific board meeting, the TC will invite additional members of the collaboration with specific knowledge or particular expertise to participate. In addition, for major decisions, the TC will officially appoint internal collaboration referees with no associated conflicts of interest to assist in evaluating the technical issues behind these major decisions.

### 3.4 Technical coordination organization

The TC heads an organization that supports the work of the consortia and has responsibility for a number of major project support functions prior to the delivery of detector components to SURF including

- ensuring that each consortium has a well defined and complete scope, that interactions between consortia are sufficiently well defined, and that any missing scope outside of the consortia is provided through other sources such as collaboration common funds;
- defining and documenting scope boundaries and technical interfaces both between consortia and with LBNF;
- developing an overall schedule with appropriate dependencies between activities covering all phases of the project;
- ensuring that appropriate engineering and safety standards are developed, understood, and agreed to by all key stakeholders and that these standards are conveyed to and understood by each consortium;
- ensuring that all DUNE requirements on LBNF for FSCF, cryostat, and cryogenics are clearly defined and agreed to by each consortium;
- ensuring that each consortium has well developed and reviewed component designs, construction plans, quality control (QC) processes, and safety programs; and
- monitoring the overall project schedule and the progress of each consortium towards delivering its assigned scope.

The DUNE technical coordination organizational structure is shown in figure 3.3. The structure incorporates teams with responsibilities for project coordination, engineering support, and installation interfaces. Many technical coordination team members also contribute to the activities of the JPO teams (shown in figure 2.2) in order to ensure coherence in project support functions across LBNF/DUNE.

The technical coordination project coordination team incorporates ES&H, QA, and project controls specialists. Overall integration of the detector elements is coordinated through the technical coordination engineering support team headed by the LBNF/DUNE systems engineer and lead DUNE electrical engineer. Planning coordinators for integration and installation activities at SURF sitting within the LBNF/DUNE integration office also head the technical coordination installation interfaces team. The dual placement of these individuals facilitates the required coordination of integration and installation planning efforts between the core team directing these activities and the DUNE consortia, which maintain primary responsibility for the individual detector subsystems. Members of the technical coordination organization meet weekly to review project progress and discuss technical issues.

Within the framework of the DUNE FD construction project, technical coordination project support functions associated with its coordination role include safety, engineering integration, change control, document management, scheduling, risk management, conducting reviews, and workflow. These functions are described in the following sections.



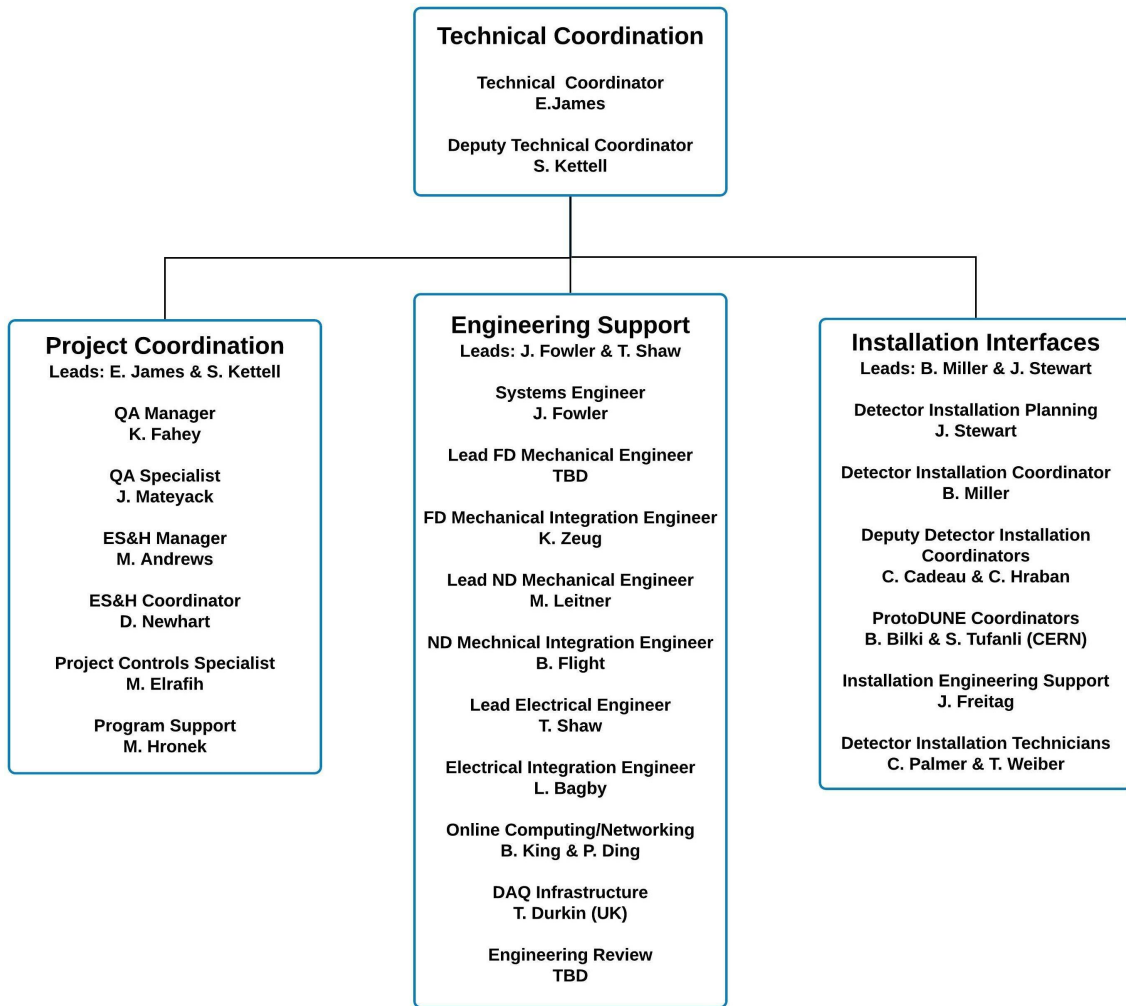

Figure 3.3. DUNE technical coordination organizational chart.

### 3.4.1 Safety

The TC is responsible for implementing the safety program covering the DUNE construction project. The TC is supported in this role by the LBNF/DUNE ES&H manager. A dedicated DUNE ES&H coordinator sits within the technical coordination organization and guides the DUNE safety program under the direction of the LBNF/DUNE ES&H manager. The safety organization for the DUNE construction project is shown in figure 3.4 and is further described in chapter 10.

The DUNE construction project is carried out at many different institutions in many different countries. Participating institutions sign a MoU in which they agree to abide by the requirements of the DUNE safety program. Each of the participating institutions assumes primary responsibility for the safe execution of their assigned construction activities. The DUNE ES&H coordinator interacts with all participating institutions to ensure that their programs comply with DUNE safety requirements. Prior to the start of any construction activities, the DUNE ES&H coordinator participates in the production readiness review incorporating on site visits to confirm that approved safety controls are in place. Follow-up on site visits by the DUNE ES&H coordinator, including produc-

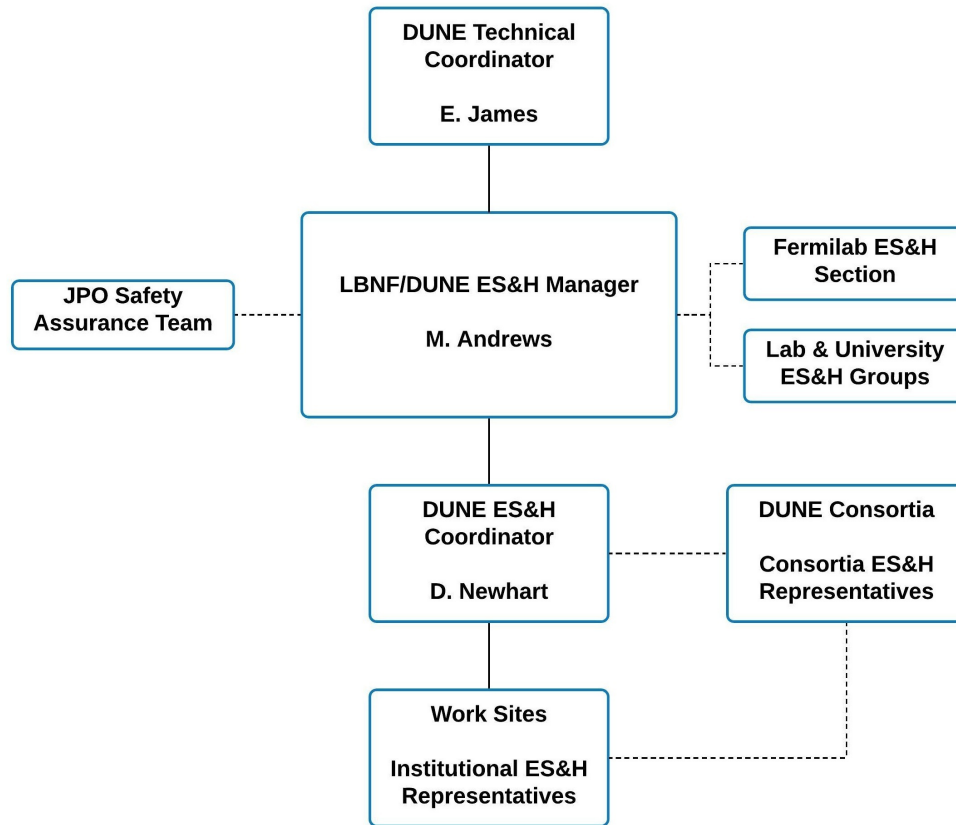

Figure 3.4. High level DUNE construction ES&H organization.

tion progress reviews, over the course of the construction period are used to validate continuing compliance with program requirements.

### 3.4.2 Engineering integration

DUNE technical coordination works with the collaboration to collect and validate requirements associated with the FD modules. Each detector module has its own set of high-level requirements with potential effects on the DUNE physics program, which are owned by the DUNE EB. The EB must approve any proposed changes to these requirements. Lower-level technical requirements associated with each detector subsystem are developed by the consortia under the guidance of the technical coordination engineering support team. Appendix A.3 contains tables summarizing the high-level requirements associated with each of the FD modules.

Starting from these requirements, the technical coordination engineering team responsible for detector integration works with the DUNE consortia to build and validate integrated detector models from the designs of the individual subsystems. The team ensures that the detector subsystems fit together properly and that the fully assembled detectors meet structural requirements associated with all operational conditions (both warm and cold), as is discussed further in chapter 7. The team is responsible for validating that the integrated detector designs satisfy the defined requirements needed to meet the goals of the DUNE physics program.

Integration of the full detector models within the global model encompassing the detector caverns and supporting infrastructure is the responsibility of the central JPO engineering integration team. The technical coordination engineering team is responsible for validating interfaces within the combined model between DUNE detector components and supporting infrastructure pieces. All proposed changes to the global model require approval from the TC based on guidance received from the lead engineers embedded within the technical coordination detector integration team.

As part of these efforts, the engineering team works with consortium leadership teams to develop controlled documents describing interfaces between the different detector subsystems. These documents are placed under signature control within the LBNF/DUNE document management system. Proposed changes to interface documents must be approved by the consortium leadership teams on both sides of the interface as well as by the lead engineers in the technical coordination detector integration team.

The technical coordination engineering team works with the LBNF/DUNE systems engineer, who heads the JPO configuration and integration team, to develop required documents detailing interfaces between the LBNF and DUNE FD construction projects and the interfaces of these projects with LBNF/DUNE installation and integration activities at SURF. These LBNF/DUNE interface documents are placed under signature control within the LBNF/DUNE document management system and proposed changes require approvals from both the lead LBNF/DUNE systems engineer and the responsible individuals associated with each branch of the global project (LBNF project manager, DUNE TC, and project integration director).

Appendix A.1 contains a table cataloging the DUNE interface documents and providing web links for accessing approved versions in place at the time of the release of this document.

### 3.4.3 Change control and document management

The DUNE project follows the LBNF/DUNE change control process described in section 7.5 and section 9.6.2. The decision path for changes not impacting the LBNF project or LBNF/DUNE installation activities at SURF is self-contained within the DUNE collaboration management structure. A hierarchy of decision-making levels is defined based on pre-determined thresholds related to the extent of the proposed change with the most significant changes requiring DUNE EB approval.

For document management, the DUNE construction project relies on the LBNF/DUNE document management system administrated by the JPO engineering integration team configuration manager. Technical coordination works with the LBNF/DUNE QA manager to ensure that the information needed to track the history of each detector component through construction, assembly, and testing is properly captured within the PBS database. A dedicated DUNE QA specialist sits within the technical coordination organization and coordinates the DUNE QA program under the direction of the LBNF/DUNE QA manager. The DUNE QA program is described in much greater detail in chapter 9.

### 3.4.4 Schedule

The lead project controls specialist within the technical coordination team works with the DUNE consortia to build schedules covering the design, testing, and construction activities associated with their subsystems and incorporate these within the LBNF/DUNE schedule. The project controls

specialist communicates with consortia technical leads on a monthly basis to track the status of activities and update the LBNF/DUNE schedule accordingly. Milestones positioned at regular intervals within the subsystem construction schedules are incorporated to enable high-level tracking of these efforts. Section A.2 (in appendix A) contains a table summarizing key detector milestones around which the individual consortia schedules are constructed.

### 3.4.5 Risk management

DUNE technical coordination maintains a global registry containing both subsystem-specific risks identified by the consortia and self-held risks associated with the overall coordination of the DUNE construction project as discussed in sections A.5 and A.6. The TC uses Project Board Meetings to regularly review the risk registry with the consortium leadership teams and define mitigation actions as necessary to prevent identified risks from being realized. The TC does not have control over contingency funds held by the internal projects of the participating funding agencies. In cases of identified need, the TC works with the consortium leadership teams to implement risk reduction strategies. Identified issues that cross consortia boundaries are discussed at project board meetings and brought to the DUNE EB if they need to be addressed at a higher level.

Appendix A.5 contains tables summarizing the highest-level identified risks within the technical coordination risk registry.

### 3.4.6 Review process

The TC has primary responsibility for conducting design and production readiness reviews covering each detector subsystem. As described in section 2.4.5 and chapter 8, reviews are coordinated through the JPO review planning team to ensure coherence in the review process across the entire LBNF/DUNE enterprise. The deputy TC is the JPO team member responsible for organizing the reviews. The full review process is described in greater detail in chapter 8.

## 3.5 DUNE work flow

Table 3.1 lists the time-ordered set of activities required to realize the DUNE FD modules, from the design of individual detector components through operation of the fully-assembled modules. Primary responsibility for the detector subsystems is held by the DUNE consortia over the full course of these activities. DUNE technical coordination under the direction of the TC is responsible for coordinating the consortia efforts related to the design, prototyping, fabrication, and transport (to South Dakota) of the required detector elements. Efforts related to the receipt (in South Dakota), processing, installation, and check-out of detector components are coordinated through the integration office under the direction of the project integration director as described in chapter 4. The integration office also coordinates efforts related to the installation and commissioning of the supporting cryogenic infrastructure, for which the LBNF project has responsibility. The DUNE collaboration takes responsibility for coordinating activities occurring after the cryostats are filled with liquid argon beginning with final commissioning of the detectors and continuing into long-term detector operation.

Although the organizations responsible for coordinating activities during each stage of the time-ordered process required to bring the FD modules online are clearly delineated in table 3.1,

**Table 3.1.** Responsibility matrix for activities occurring during each phase of the process for implementing the DUNE FD modules.

Phase	DUNE Consortia	DUNE technical coordination	DUNE Collaboration	LBNF/DUNE IO	LBNF
Design	Lead	Coordinate	Support	Support	
Prototype	Lead	Coordinate	Support	Support	
Fabricate	Lead	Coordinate	Support	Support	
Ship	Lead	Coordinate	Support	Support	
Receive	Lead	Support	Support	Coordinate	
Integrate	Lead	Support	Support	Coordinate	
Install	Lead (Detector)	Support	Support	Coordinate	Lead (Cryogenics)
Commission (Cryogenics)			Support	Coordinate	Lead
Commission (Detector)	Lead		Coordinate	Support	Support
Operate	Lead		Coordinate		

additional, important support roles are connected to each stage. The integration office interacts with DUNE technical coordination during detector design, prototyping, and construction to ensure that detector elements integrate properly within the supporting infrastructure. Participation of the consortia in the planning process for integration and installation activities at SURF is facilitated through DUNE technical coordination. The DUNE collaboration also provides support throughout the entire process. The collaboration is responsible for defining the DUNE science program and performing the physics studies used to define detector requirements. The collaboration also provides resources that support acquisition of common detector infrastructure items sitting outside the scope of the consortia as well as necessary personnel and equipment to support integration and installation efforts at SURF.

During each stage of the time-ordered process for implementing the FD modules, issues may arise requiring high-level decisions on steps required for moving forward. Table 3.2 summarizes which body within the global project structure (DUNE EB or EFIG) takes responsibility for high-level decision-making during each stage of the DUNE FD construction project.

**Table 3.2.** Responsibility matrix for high-level decision-making occurring during each phase of the process for implementing the DUNE FD modules.

Phase	Decision-making
Design	DUNE EB
Prototype	DUNE EB
Fabricate	DUNE EB
Ship	DUNE EB
Receive	EFIG
Integrate	EFIG
Install	EFIG
Commission - Cryo	EFIG
Commission - Det	DUNE EB
Operate	DUNE EB

The DUNE project has already completed an initial round of design and prototyping activities culminating in the construction and operation of the ProtoDUNE detectors. Moving forward, the project is updating detector component designs to account for lessons learned from the ProtoDUNE experience. Once the designs are final, the project will construct first production versions of all components that will be installed and operated in a second phase of ProtoDUNE operations prior to the start of full-scale production. The operation of the ProtoDUNE-2 detectors will follow roughly two years after the end of operations for the corresponding ProtoDUNE detectors. In a few cases, the production of long lead-time components will need to be started in parallel with the operation of first production components in ProtoDUNE-2.

## Chapter 4

# Detector installation and commissioning organization

As discussed in chapter 2, the project integration director has responsibility for coordinating the planning and execution of the LBNF/DUNE installation activities, both in the underground detector caverns at SURF and in nearby surface facilities. The DUNE consortia maintain responsibility for their subsystems over the course of these activities and provide the expert personnel and specialized equipment necessary to integrate, install, and commission their detector components. Likewise, LBNF has responsibility for activities associated with the installation of supporting infrastructure items, which are coordinated under the direction of the project integration director.

The LBNF/DUNE integration office will evolve over time to incorporate the team in South Dakota responsible for the overall coordination of on site installation activities. In the meantime, the installation planning team within the integration office works with the DUNE consortia and LBNF project team members to plan these activities.

The integration office installation planning team is responsible for specification and procurement of common infrastructure items associated with installation of the detectors that are not included within the scope of the DUNE consortia. Some of these items are detector components such as racks, cable trays, cryostat flanges, and mechanical structures for supporting the detectors within the cryostats. Others are general items required for detector installation such as clean rooms, cranes, scaffolding, and personnel lifts.

The on site integration office team includes rigging teams responsible for moving materials in and out of the shaft, through the underground drifts, and within the detector caverns. It includes personnel responsible for overseeing safety and logistics planning. These team members are anticipated to sit within the SDSO, an organization formed to provide Fermilab support services in South Dakota.

### 4.1 Far site safety

The foundation of a credible installation plan is an ES&H program that ensures the safety of team members and equipment supporting the program, as well as protection of the environment at the SURF site. The project integration director has responsibility for implementing the LBNF/DUNE

ES&H program for installation activities in South Dakota. The LBNF/DUNE ES&H manager heads the on site safety organization and reports to the project integration director to support the execution of this responsibility.

The far site ES&H coordinators sitting under the LBNF/DUNE ES&H manager oversee the day-to-day execution of the installation work as shown in figure 4.1 and described further in chapter 10.

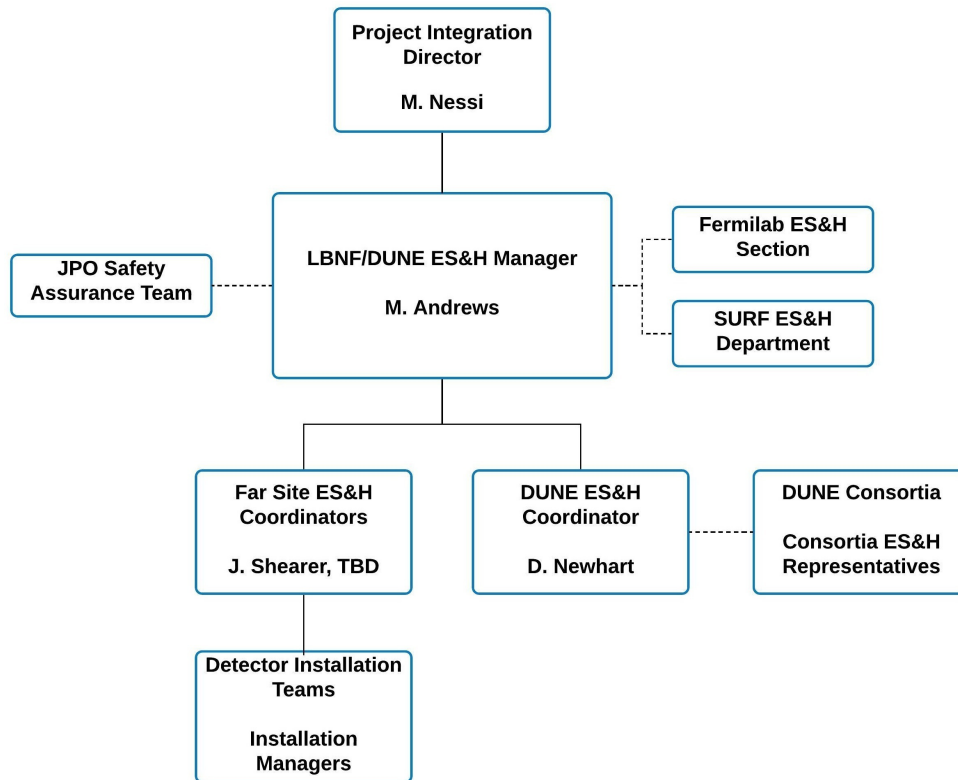

Figure 4.1. High level DUNE installation ES&H organization.

As we move to two-shift installation activity, additional far site ES&H coordinators will be assigned to each work shift. The safety coordinator assigned to a particular shift is responsible for leading safety discussions during toolbox meetings and for ensuring that all workers on that shift, including those from the consortia or contractors, are properly trained. The reporting chain for safety incidents goes through the on site safety team to the LBNF/DUNE ES&H manager to minimize any potential conflicts of interest. All integration office installation team members as well as DUNE consortia personnel and LBNF project team members have the right to stop work for any safety issues.

Operation of all equipment used for installation activities such as cranes, power tools, and personnel lifts is restricted to team members who have been properly trained and certified for use of that equipment. The safety coordinator for each shift is responsible for ensuring that all team personnel are properly trained and that safety documentation and work procedures are up-to-date and stored within the EDMS.



Documentation, including accident reports, near misses, weekly reports, equipment inspection, and training records is an important component of the LBNF/DUNE ES&H program. The work planning and hazard analysis (HA) program utilizes detailed work plan documents, HA reports, equipment documentation, safety data sheets, personnel protective equipment (PPE), and job task training to minimize work place hazards and maximize efficiency. Sample documentation is developed through the Ash River trial assembly process, which maps out the step by step procedures and brings together the documentation needed for approving the work plan. The sample documentation is modified to account for differences required for performing work underground and the updated procedures are provided to the review process (as discussed in chapter 8) for installation readiness reviews and operational readiness reviews.

#### 4.2 Integration office management

The project integration director is responsible for coordinating all installation activities at SURF including those that fall under the responsibility of LBNF and the DUNE consortia. The coordinators of this activity and crucial technical support staff sit within the integration office. The organization of this on site team is shown in figure 4.2.

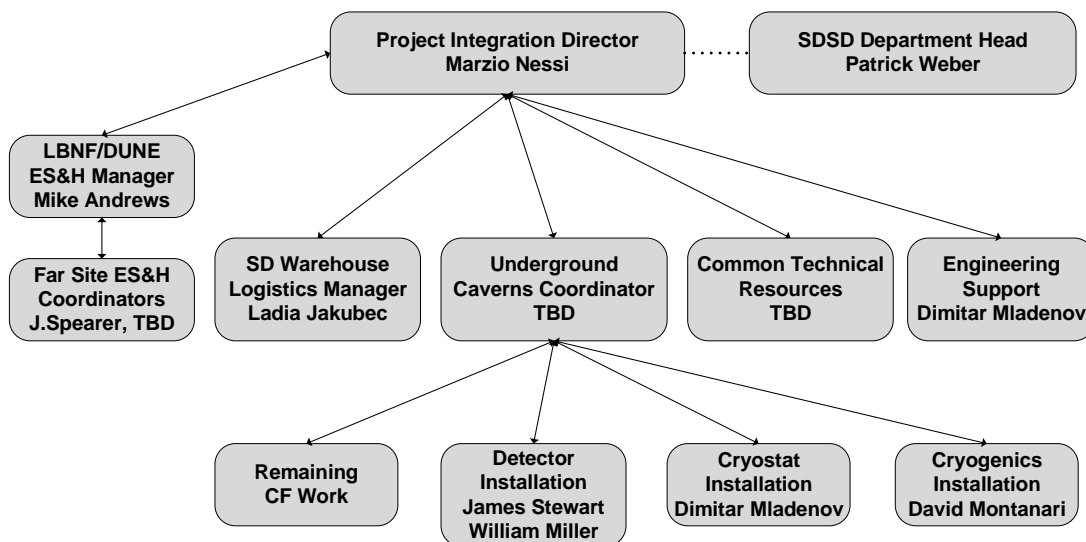

Figure 4.2. Integration office installation team organization chart.

As discussed in section 4.1, the on site safety organization including the far site ES&H coordinators working under the direction of the LBNF/DUNE ES&H manager oversee all on site activities and report to the project integration director.

Since SURF lacks space on the surface, a separate warehousing facility in the vicinity of SURF is required to receive and store materials in advance of their delivery to the underground area, as discussed in section 4.2.1. Warehouse operations are coordinated by the LBNF/DUNE logistics manager who is tasked with determining the exact sequence in which materials are delivered into the underground areas.

The underground cavern coordinator is responsible for managing all activities in the two underground detector caverns, as well as the CUC, including contracted workers. Work within the detector caverns follows a time-ordered sequence that includes installation of the cryostats (warm and cold), cryogenic systems, and the detectors themselves. Work in the CUC includes installation of major cryogenic system pieces and the detector DAQ electronics. The underground cavern coordinator relies on separate installation teams focusing on cryostats, cryogenic systems, and the detectors. The cryostat and cryogenics system installation teams are contracted resources provided by LBNF. For this reason, coordinators of these activities are jointly placed within both the LBNF project team and the integration office. The detector installation teams incorporate a substantial number of scientific and technical personnel from the DUNE consortia. Integration office coordinators of the detector installation effort are jointly placed within DUNE technical coordination to facilitate consortia involvement in detector installation activities. Any modifications to the facilities occurring after AUP are managed by the underground cavern coordinator under the direction of the project integration director.

The project integration director manages common technical and engineering resources to support installation activities. Technical resources include the support crews needed for rigging materials on and off the hoist at the top and bottom of the shaft, transporting materials to the underground caverns from the bottom of the shaft, and rigging the detector and infrastructure pieces within the underground caverns during the installation process. Welders and survey teams are used in all installations, as are on-call electricians and plumbers. Electricians and plumbers are also needed for operational issues that may arise. They are provided through SDSD, which employs full-time staff and contracts with support staff for necessary functions.

Engineering resources for installation activities sit within the integration office. The engineering team, which includes both mechanical and electrical engineers, resolves last minute issues associated with component handling and detector grounding that arise over the course of the installation process. Other required engineering functions include procurement support, configuration management, and participation in the safety review process.

### 4.2.1 South Dakota Warehouse Facility

The South Dakota Warehouse Facility (SDWF) is a leased 5000m<sup>2</sup> facility hosted by SDSD. Approximately six months before AUP of the underground detector caverns is received, the SDWF must be in place for receiving cryostat and detector components. Laydown space near the Ross headframe is extremely limited. For this reason, the transportation of materials from the SDWF to the top of the Ross shaft requires careful coordination. The LBNF/DUNE logistics manager works with the construction manager/general contractor (CMGC) through the end of excavation activities and with other members of the integration office team to coordinate transport of materials into the underground areas. Since no materials or equipment can be shipped directly to the Ross or Yates headframes, the SDWF is used for both short and long-term storage, as well as for any re-packaging of items required prior to transport into the underground areas.

A small number of DUNE consortia members work at the SDWF to check received components for potential damage incurred during shipment and to track all materials coming in and out of the facility, using the inventory management system. In some cases, re-packaging of materials is

required for lowering them down the shaft into the underground areas. The DUNE consortia take responsibility for these efforts.

#### 4.2.2 Underground caverns

The installation process in the underground detector caverns and CUC can be broken into a time-sequenced set of activities, coordinated through the integration office. In the detector caverns, installation of the warm and cold cryostat structures is followed by (with some overlap) installation of the cryogenic infrastructure and detectors. In the CUC, installation of the DAQ infrastructure and detector readout components proceeds in parallel with that of the cryogenic infrastructure. A high-level schedule showing the inter-dependencies between these activities is shown in figure 4.3.

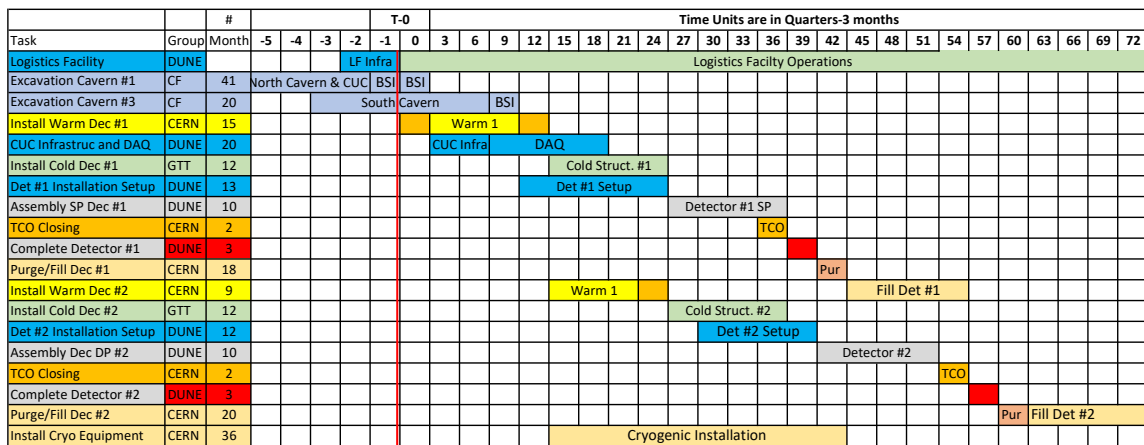

Figure 4.3. Summary schedule of the different phases of work underground.

The ability of LBNF/DUNE to meet this schedule depends critically on its ability to work within limitations on the total number of people allowed in the underground areas at a given time (144 people) as well as occupancy limits on work in the cryostat. In order to satisfy these limitations, careful balancing of the numbers of workers assigned to different concurrent tasks taking place within the different underground caverns is required. This is a particular challenge during the excavation period for the second detector cavern, which runs in parallel with cryostat installation in the first detector cavern. The integration office works with its LBNF/DUNE project partners to manage and optimize the underground work schedule so that interferences between concurrent work efforts are minimized.

The underground cavern coordinator manages the contributions of the technical team supporting installation activities. The size of the technical support team is anticipated to evolve over time to meet the needs of the specific installation tasks taking place. The functions provided by the technical team supporting the work in the underground caverns include the following:

- material transport: the transport team shown in figure 4.4 is responsible for unloading of materials from the trucks arriving from the SDWF, loading or rigging of materials at top of Ross Shaft, unloading or rigging of materials at bottom of Ross Shaft, and delivery

of materials from the bottom of shaft to the underground caverns. This does not include operation of the hoists, which is performed by SURF.

- cavern rigging operations: storage of components within the available spaces in the cavern and movement of materials as required to execute the installation process (three rigging stages for detector installation are moving components into clean room, integrating components within clean room, and installing integrated elements inside cryostat).
- installation technicians: general technician support for specific installation activities.
- welders and survey crews: perform specific tasks incorporated within each of the different installation efforts.
- electrical technicians and plumbers: on-call support staff to modify systems as work transitions from one stage to the next and to address issues as they arise.

The organization responsible for managing contributions of the technical support team to the installation activities taking place in the underground caverns is shown in figure 4.4. The structure is illustrated for the case of the largest anticipated workforce (approaching roughly 60 team members in total covering multiple shifts) for the periods with ongoing detector installation efforts. These personnel support two 10-hour shifts on Mondays through Thursdays and a day shift on the remaining days to cover activities occurring over weekends.

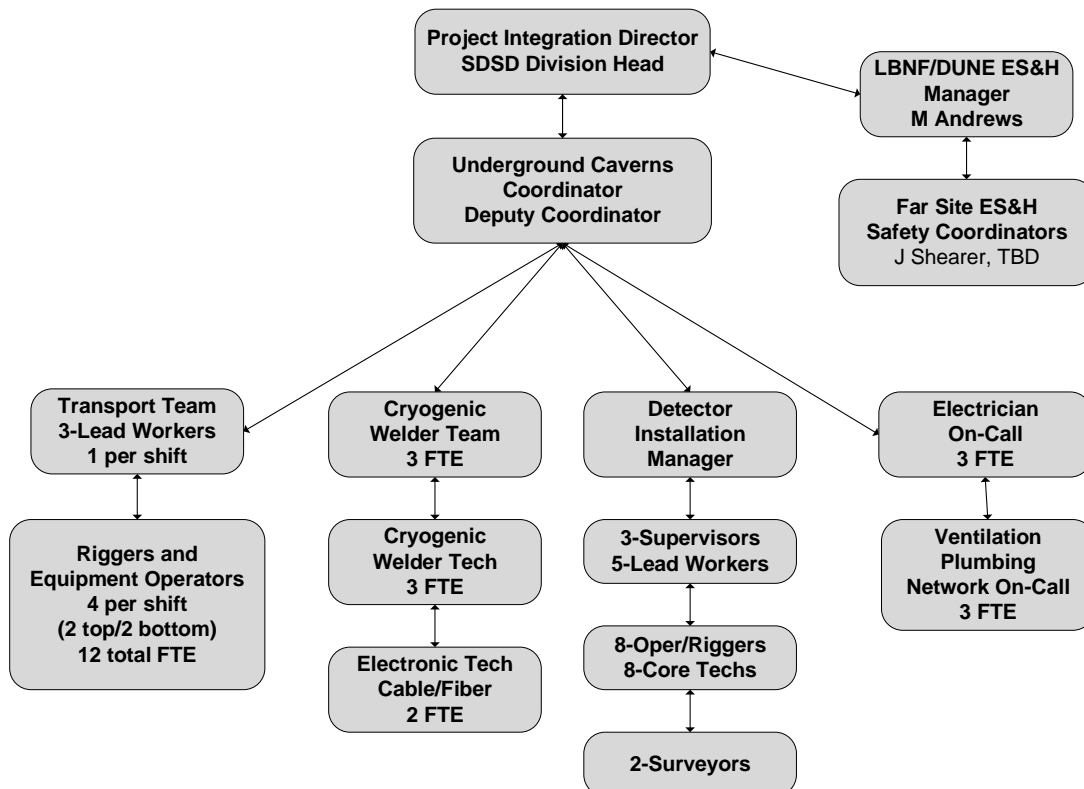

Figure 4.4. Summary of the integration office/SDSD common technical resources.

On the surface at the start of each shift, there is a toolbox safety meeting and work assignment update. An hour separates the two shifts, in which the lead workers, safety coordinators, and other management team members are paid overtime to overlap with each other and transfer information from one shift to the next. The safety coordinator for each shift is responsible for conducting the safety discussion at the meeting and ensuring that all workers assigned to that shift have the proper training.

The team responsible for detector installation incorporates members of the technical support team described above and includes scientific and technical personnel from the DUNE consortia. The team is led by the detector installation manager who has three shift supervisors working with them to provide on site coverage for every shift. The management team works with the underground cavern coordinator to ensure that required technical support team members are available as needed and that required materials are delivered to the detector caverns on a schedule to keep the installation effort moving forward.

The management team supervises technical resources assigned to the detector installation effort and works with consortia team members to maximize the overall efficiency of the installation process. The organizational structure to manage the detector installation activities is shown in figure 4.5.

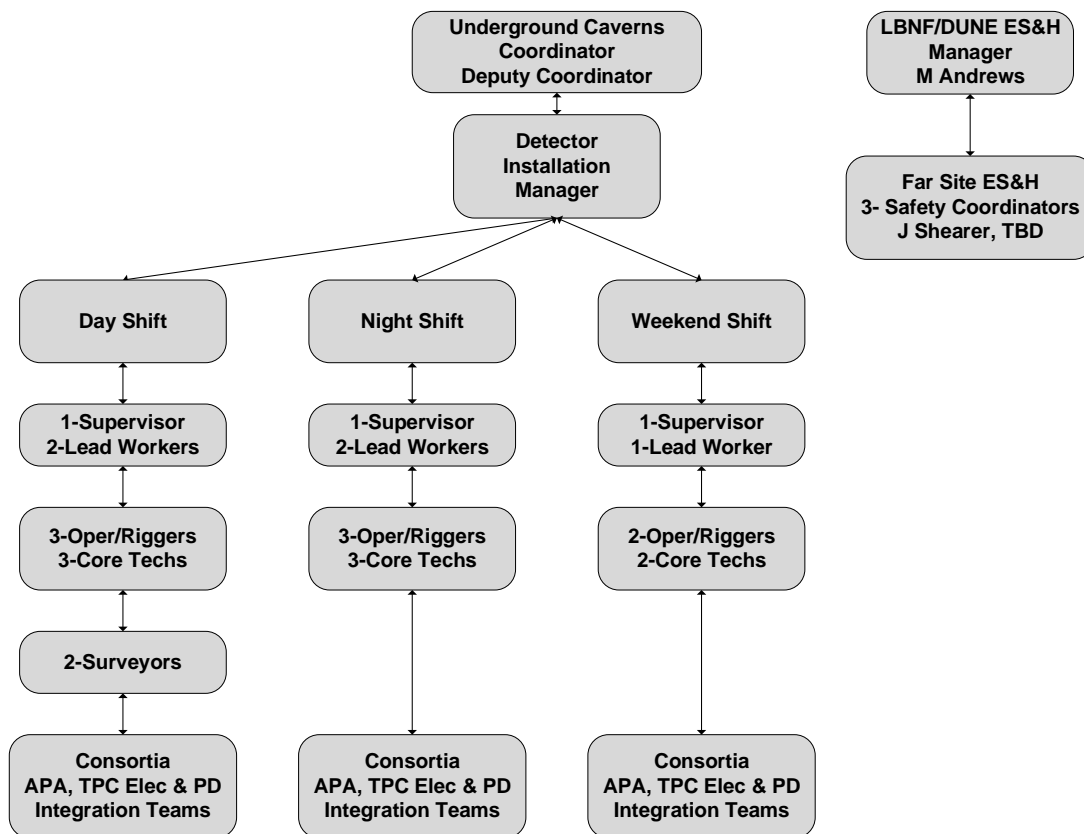

Figure 4.5. The underground installation team (UIT).

The detector installation manager oversees all shifts and serves as the supervisor for specific shifts as needed. They serve as the contact with the underground cavern coordinator for obtaining

required technical support team members and organizing the delivery of needed materials into the detector caverns. The detector installation manager attends all high-level meetings with the underground cavern coordinator and is tasked with submitting weekly progress reports. They work with the DUNE consortia to manage the overall work schedule and ensure that the correct resources are in the right place at the right time.

The installation supervisors are working managers, trained as riggers and equipment operators to fill in as needed on their shifts. They are fully trained in all installation procedures and work with the consortia shift team members to keep the installation effort on schedule. Installation supervisors fill in for their lead workers as needed and are the primary points of contact for information exchange between shifts. Lead workers direct the technical support personnel assigned for their shift. The lead workers are trained in all installation procedures and provide assistance to the consortia work teams as needed.

#### 4.2.3 Trial assembly at Ash River

The trial assembly work at Ash River, site of the NOvA far detector, focuses on mechanical tests of the installation process for DUNE. This effort is critical to confirm final detector component designs, including modifications originating from ProtoDUNE, confirming and practicing installation techniques for both the cleanroom and cryostat. The NOvA far site detector hall in Ash River, Minnesota, has facilities that match DUNE needs, including a 16.75 m deep pit with  $\sim 300 \text{ m}^2$  of floor space available for testing full-scale DUNE detector components and a capable workforce that is needed for NOvA operations and can be leveraged in a cost effective manner for DUNE. The NOvA far detector laboratory is managed by the University of Minnesota (UMN) and is partially funded through an operations contract from Fermilab. Work performed at the Ash River site follows university safety regulations and any DUNE safety requirements. University code officials approve all building permits, which include engineered drawings signed by an engineer registered in Minnesota. All hazard analyses and work procedure documents are approved by the joint DUNE/UMN safety committee with members drawn from both the University of Minnesota (UMN) and DUNE that includes specialists as needed.

The work at Ash River has five main goals:

- use prototype DUNE components to verify that the detector can be installed in a safe and efficient manner,
- test installation equipment needed to install the DUNE detector at SURF,
- validate mechanical design changes made to the detector elements subsequent to ProtoDUNE operation,
- complete a set of reviewed engineering and procedural documents that will serve as the basis for work to be performed underground at SURF, and
- serve as a training center for personnel who will contribute to DUNE installation at SURF.

The full time staff of five people at Ash River includes a manager, deputy manager, and three experienced technicians that all participated in ProtoDUNE-SP installation at CERN and the

ProtoDUNE-SP trial assembly at Ash River. The staff oversees operations of the NOvA detector and performs trial assembly studies of the DUNE detector components. One of the three technicians also serves as the site safety officer and chairperson of the joint DUNE/UMN safety committee. Two additional staff members will be added in the near future to handle the additional workload associated with preparations for the ProtoDUNE-2 installation effort.



**Figure 4.6.** Phase 1 APA installation frame (in red) being installed on the APA assembly tower at Ash River. In the foreground is the ProtoDUNE-SP trial assembly structure.

The work at Ash River is divided in three major phases:

- Phase 0: a vertical cabling test using two full-scale APA side tubes connected top to bottom and mounted against a vertical column in the detector hall. Using this setup the proposed cable bundles have been run through the tubes to see how well the designed conduit system functions. This work has led to several proposed modifications to the designs that are currently

being considered. The older ProtoDUNE trial assembly structure is concurrently being used to perform mechanical tests of ProtoDUNE-2 components.

- Phase 1: a prototype of the DUNE APA assembly tower using a steel frame large enough to hold a commercial stair scaffold within its mid-section, as shown in figure 4.6, was constructed and

used to test the process for connecting top and bottom APA pairs together and installing the required cable bundles. The next step will be to add a cathode plane assembly (CPA) assembly station and test assembly procedures for the updated CPA designs. A prototype APA shipping frame is also being constructed to test the mechanical features of the shipping container design.

- Phase 2: a more complex steel structure will be designed and fabricated to mock up the network of rails and support structures used to install the DUNE FD modules including pieces of the detector support system (DSS) that sits inside the cryostat. This structure, as illustrated in figure 4.7, will provide a platform for performing more detailed tests of the proposed detector installation plan. Installation steps to be tested include DSS installation, transfer of time projection chamber (TPC) components through the temporary construction opening (TCO), installation of the TPC end walls, cabling through the cryostat penetrations, movement of the APA and CPA pairs into their final positions, and deployment of the top and bottom field cage modules.

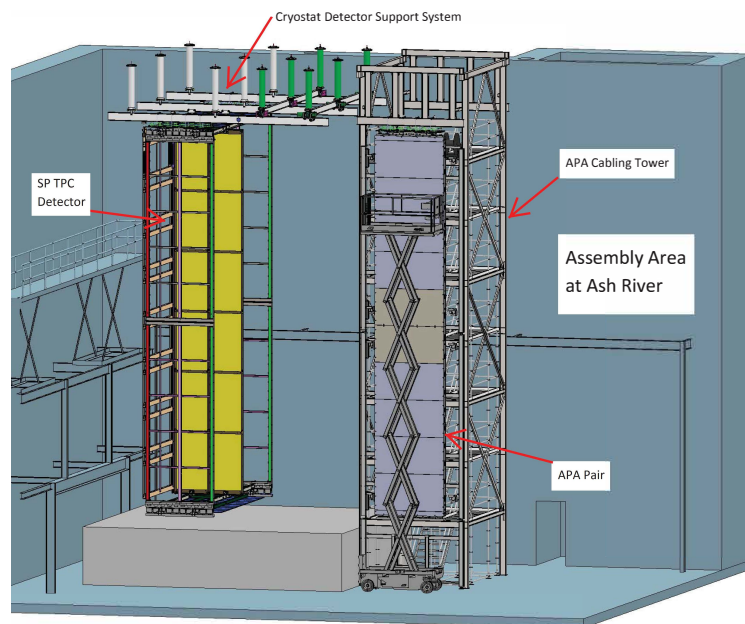

Figure 4.7. Phase 2 trial assembly at Ash River.



### 4.3 South Dakota Services Division

SURF is operated by the South Dakota Science and Technology Authority (SDSTA) through a cooperative agreement with the DOE. Prior to this agreement going forward, SDSTA signed onto a MoU with the Fermi Research Alliance (FRA) detailing facility support services to be provided by SDSTA in support of LBNF/DUNE. The MoU establishes a Joint Coordination Team with regularly scheduled meetings to ensure that all SURF support functions necessary for achieving LBNF/DUNE objectives are provided.

Fermilab has established the SDSD to support integration and installation activities in South Dakota. SDSD will support these activities, which are the responsibility of the project integration director, by providing access to the required technical resources. These resources include dedicated Fermilab personnel sitting within the division and contracted labor provided through the division. Some examples of SDSD support staff include rigging teams to support activities in underground caverns and at the headframe and bottom of the shaft, transport crews for moving materials between the warehouse and site and from the bottom of the shaft into the underground caverns, and a core group of technicians for performing maintenance and installation activities. SDSD will also assist LBNF/DUNE partners in understanding work requirements at SURF and ensuring that appropriate provisions are incorporated into partner contracts with external contractors. The SDSD will have its own procurement team to assist the project integration director in acquiring the common infrastructure items required for the installation effort. This team will also be responsible for handling any contracts associated with further work on the facilities subsequent to departure of the LBNF CMGC.

Much like the Ash River site, where University of Minnesota officials are responsible for any building permits, SDSD is responsible for any electrical or building permits required for the leased spaces at SURF. SDSD also takes responsibility for badging personnel requiring access to the leased areas at SURF in coordination with the Fermilab Global Services Office and the SURF Administrative Services Office. This includes providing and coordinating the trainings required to access surface and underground areas. To maintain safe working conditions within the leased areas, SDSD performs regular inspections and maintenance of all LBNF/DUNE equipment operating at SURF including lifts, conveyances, networking equipment, cooling and ventilation equipment, rigging equipment, electrical power installations, life safety systems, and controlled access equipment.

2020 JINST 15 T08009

## Chapter 5

# Facility description

The DUNE detectors are located in the main underground campus at SURF. The main campus is located at the 4850 foot level (4850L), between the Ross and Yates Shafts. This campus and associated surface facilities are being developed by LBNF through excavation (EXC) and outfitting (building and site infrastructure (BSI)) contracts with the civil contractor. Once the contractor has delivered and AUP has concluded, cryostat construction will commence. Further infrastructure will be delivered by SDSD. The following sections describe the facilities as they are related to the DUNE detectors.

### 5.1 Underground facilities and infrastructure

The DUNE underground campus at the SURF 4850L is shown in figure 5.1.

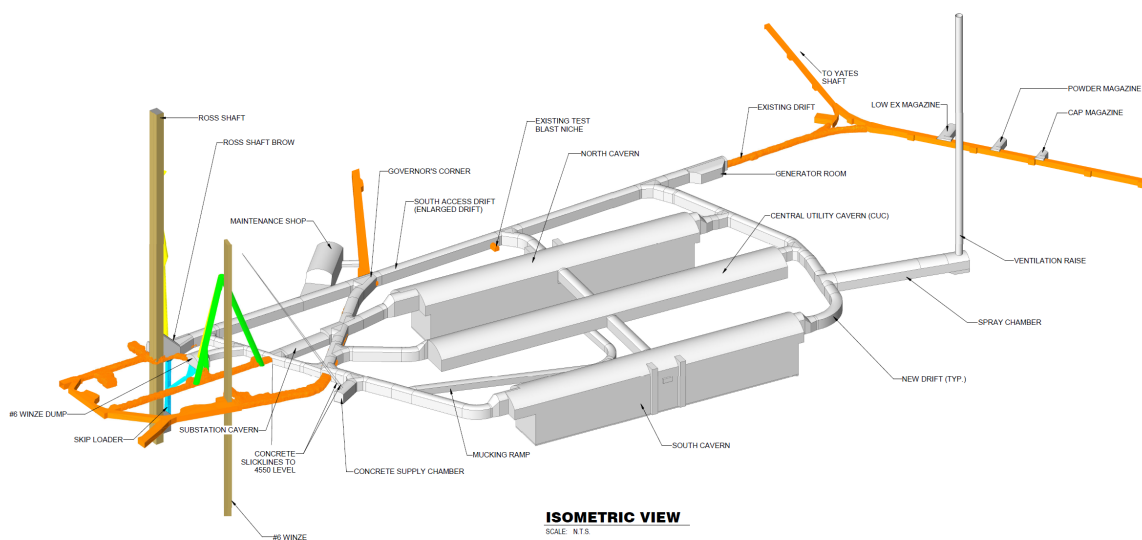

**Figure 5.1.** Underground campus at the 4850L.

LBNF will provide facilities and services, on the surface and underground, to support the DUNE detectors. This includes logistical, cryogenic, electrical, mechanical, cyber, and environmental facilities and services. All of these facilities are provided for the safe and productive operation of the detector modules.

The primary path for both personnel and material access to the underground excavations is through the Ross Shaft. On the surface, the Ross Shaft and Ross Headframe are undergoing major upgrades. The structure of the headframe that supports the conveyances is being reinforced and renovated to make the work flow more efficient and safer. All of the wood timber from the 100+ year old shaft has been removed and replaced with steel sets to improve the time required to traverse the 4850L to the underground spaces. The brakes, drive, clutches, and controls for the conveyance are being completely overhauled and updated. In addition to all of these improvements, a new cage is being designed and fabricated for the Ross Shaft. The new cage incorporates features to allow the transport of larger items and includes rigging points underneath for slung loads without the removal of the cage. Details on the Ross Cage design and size constraints for material and slung loads can be found in DocDB 3582 [2].

On the surface, a new compressor building is being constructed adjacent to the headframe. This building will house the cryogenics systems for receiving cryogenic fluids and preparing them for delivery down the Ross Shaft. New piping is being installed down the Ross shaft compartment to transport gaseous argon (GAr) and N<sub>2</sub> underground.

New transformers are being installed in the Ross substation on the surface to support the underground power needs. New power cables are being installed down the Ross Shaft to transmit the power underground to a new substation.

A portion of the Ross Dry basement is being refurbished to house the surface cyber infrastructure (main communications room (MCR)) required for data and other underground information. Redundant fiber optic cables will leave the MCR to travel down both the Ross and Yates shafts to newly excavated underground communication distribution room (CDR), which is located near the west entrance drift of the north cavern. From the CDR, the fibers branch out to the CUC and detector caverns to support detector data, cryogenic and detector safety systems and will be tied into the building management system (BMS). The BMS controls the facilities fire and life safety system (FLS). All FLS signals from the detector or cryogenic safety systems will be tied into the facilities BMS for communications to personnel underground and on the surface.

### **5.2 Detector caverns**

Underground spaces are being excavated to support the four DUNE detectors and infrastructure. Two large detector caverns are being excavated. Each of these caverns will support two 17.5 kt cryostats. These caverns, labeled north and south, are 144.5 m long, 19.8 m wide, and 28.0 m high. The tops of the cryostats are approximately aligned with the 4850L of SURF with the cryostats resting at the 4910L. A 12 m space between the cryostats will be used as part of the detector installation process, placement of cryogenic pumps and valves, and for access to the 4910L. The CUC, between the north and south caverns, is 190 m long, 19.3 m wide, and 10.95 m high. The CUC will house infrastructure items, such as cryogenic equipment, nitrogen dewars and compressors, data acquisition racks and electronics, chillers for the underground cooling, and electrical services

to support the underground space and detectors. These three main caverns will be connected via a series of drifts at the 4850L as shown in figure 5.1. Access tunnels lie at the east and west ends of each cavern, the north and south sides of the north cavern, and the north side of the south cavern. Additionally, the cross section of the existing drifts where experimental components will be transported is being increased to allow passage. Other ancillary spaces being provided underground include a maintenance shop, electrical substation, concrete supply chamber, compressor room, and a spray chamber to house the cooling tower for heat rejection to the mine air for exhaust through a new 1200 foot×12 foot diameter bore hole up to the 3650L. This bore hole will provide additional ventilation to support excavation.

The first detector will be built in the east side of the north cavern and the second detector will be built in the east side of the south cavern, as shown in figure 5.2.

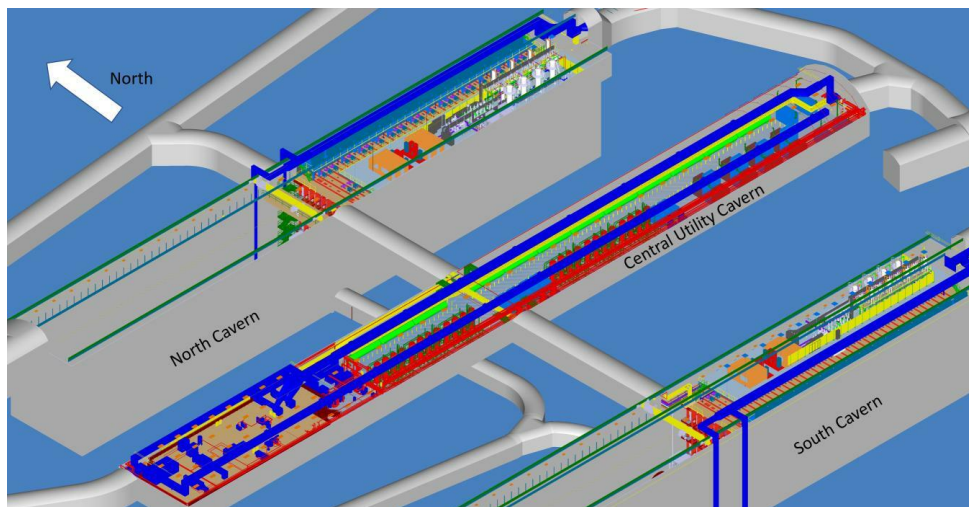

Figure 5.2. Placement of detectors in the north and south caverns.

The primary reasons for constructing the first detectors in the east sides of two caverns are:

- **Personnel safety during construction and filling:** it is planned that the first detector will be in the filling phase while the second detector is in the construction phase. Therefore, construction of the second detector has to take place in a separate cavern from filling of the first detector. In addition, the airflow in both caverns is from west to east; therefore, construction personnel who are primarily on the west side of the detectors will be upstream of the cryogens.
- **Access during construction:** the main access for bringing large items into both caverns is from the west side. It is advantageous for construction of the second detector in each cavern that items that enter from the west are directly lowered and do not have to pass over the detector construction site.

Both reasons drive the plan for detectors one and two to be built on the east side of the two separate caverns. It is therefore planned that both caverns are ready for AUP at the start of respective detector construction phases. It should be noted that both detectors will be built at the 4910L. However, with

**Chapter 5. Facility description**

the exception of the liquid argon (LAr) circulation pumps, all services are at the 4850L to facilitate access during the operations phase.

To support the electrical requirements new 35 MVA power feeds will be routed from the surface substation down the Ross Shaft to the underground electrical substation and from the substation to the electrical room in the CUC. The electrical room will have multiple transformers from which to distribute power for various functions such as lighting, HVAC, cryogenics equipment, and detector power. Each detector cavern and the DAQ room will have dedicated feeds from the electrical room. Details of this are described in the electrical section. There are multiple electrical panels planned in each cavern to provide power for the different phases of construction. These phases include the installation of the cryostat warm structure and cold membrane, detector installation and detector operations. During detector operations, separate panels are available for detector (clean) and building (dirty) power as is discussed further in section 5.7.

To support underground cooling requirements, four 400-ton chillers will be located in the CUC adjacent to the electrical room and cryogenics equipment. These chillers are designed to provide 400 kW of cooling for the various cryogenics systems, 500 kW of cooling for the electronics on each of the detectors and 750 kW of cooling to the DAQ room in the CUC. These chillers will also provide chilled water to the HVAC systems underground to maintain the ambient temperature and humidity.

Fire protection in the underground spaces will be determined by zone, hazard type, and requirements. Details of this can be found on ARUP drawing U1-FD-E-651 in the Underground Electrical package, which is shown in figure 5.3.

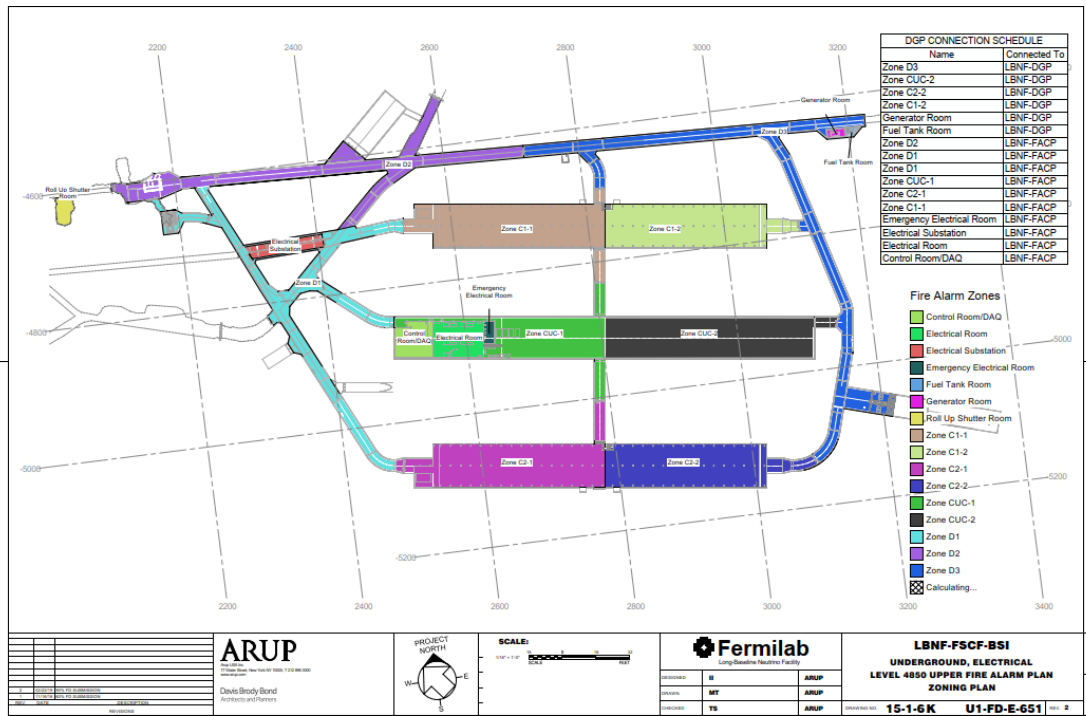

**Figure 5.3.** Underground fire zones.

2020 JINST 15 T08009

The drifts will be outfitted with normal wet type sprinklers and broken into three zones. The north and south caverns will be outfitted with a pre-action type sprinkler system to protect sensitive detector electronics from water damage from accidental release. A pre-action system requires two signals to activate. These are the detection of smoke by one of the sensors and the fusing of the sprinkler head. This type of system was the most economical choice to reduce the risk of unnecessary discharge of water over the detector electronics. The DDSS will interface with the BMS fire system to turn off power to the racks before water is introduced and reduce the impact of the water on the system and reduce the risk of electrical shock. A pre-action system will also be installed in the CUC over the cryogenic equipment as shown in the figure. In the electrical substation, electrical room, DAQ room, and CDR, a clean-agent type system will be employed. Clean-agent systems use either inert gas or chemical agents to extinguish a fire and are typically used in areas that contain sensitive electronics or data/power centers.

In addition to the above services, systems are being installed to provide compressed air, industrial water, internet, and a configurable security access system.

### 5.3 Cryostat

Each detector will be housed inside a cryostat designed to hold the liquid argon (LAr), cryogenic piping, and the detector as shown in figure 5.4.

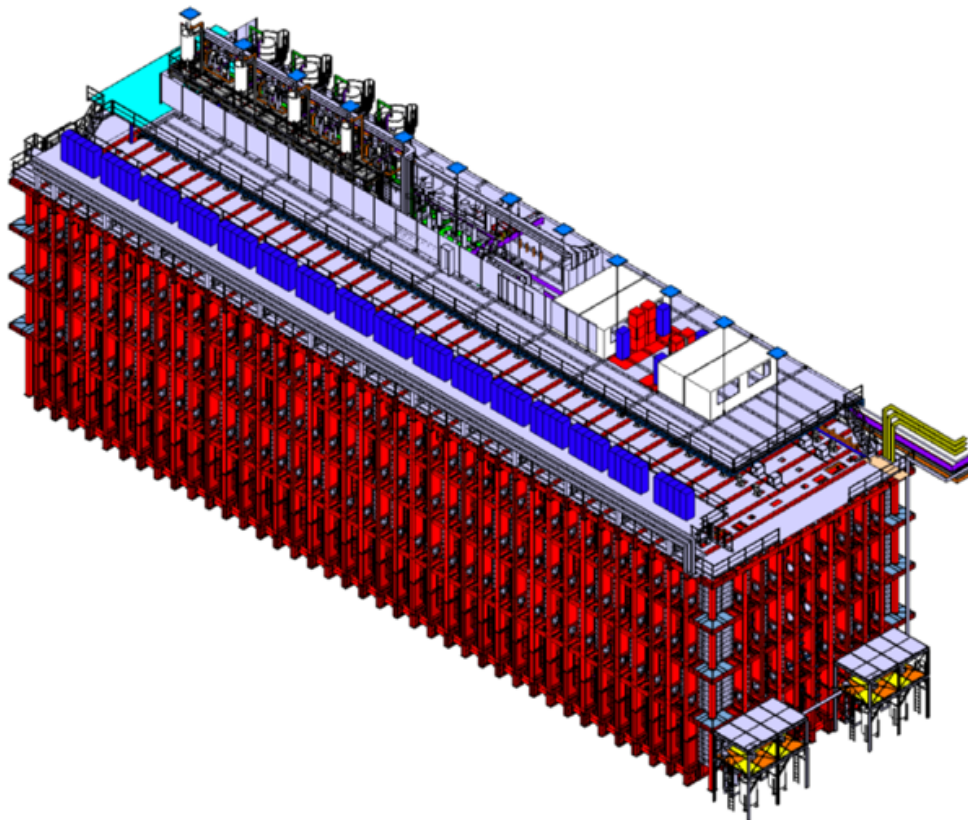

**Figure 5.4.** Overall construction and dimensions of the DUNE cryostat.

Each cryostat consists of a warm structure that provides structural support, insulating layers that maintain the temperature of the fluid inside, and the inner membrane that provides a compliant inner surface that helps to maintain the LAr purity and serves as primary containment.

The external warm structure measures 65.84 m long, 18.94 m wide, and 17.84 m high, and its internal dimensions are 63.6 m long, 16.7 m wide, and 15.6 m high. It is a welded and bolted structure constructed of I-beam elements and a 12 mm inner steel plate reinforced with ribs. It is designed to support the weight of the structure itself, insulation, inner membrane, liquid, detector, and any equipment placed on the structure. It also supports the hydrostatic pressure of the fluid inside and resists the small gas overpressure in the ullage. The structure is positioned on the concrete slab provided at the 4910L of the north and south caverns. The 12 mm inner steel plate of the warm structure also serves as the tertiary layer of containment.

The insulation layer and inner membrane will be installed inside the warm structure. The technology for this comes from the shipping vessels used for transporting liquid natural gas. The insulating layers are made from prefabricated panels of reinforced polyurethane foam. There are two layers of the foam panels that have a flexible membrane in between that serves as a secondary containment membrane. The two foam layers are installed in an overlapping pattern to reduce heat introduced into the fluid. The total thickness of the two foam layers is 0.8 m with a density of approximately  $90 \text{ mg/cm}^3$  and a residual heat input of  $6.3 \text{ W/m}^2$ . A stainless steel corrugated membrane will be installed inside the insulating layers to create the primary containment membrane for the LAr. This is constructed from 1.2 mm thick stainless steel panels that overlap and are welded together. The entire inner surface of the cryostat will be tiled with these panels to create the inner surface. These panels need to be corrugated to accommodate the shrinkage of the stainless steel from ambient temperature to LAr temperature. With the addition of the insulation and inner membrane, the internal dimensions of the finished vessel are 62 m long, 15.1 m wide, and 14 m high.

The top of the cryostat will have penetrations provided based on drawings developed by LBNF and DUNE to accommodate detector support, electronic and data cables, cryogenic pipes, and connections and other devices.

Each cryostat will have a vertical TCO on one short end. These openings will be approximately 13.43 m high and 2.68 m wide and will be used to move the detector elements into the vessel during installation. Once most of the detector material is inside the cryostat, the TCO will be closed and leak tested. After the TCO closing, the last of the detector installation will be completed. After final detector installation and equipment removal through the roof openings, the cryostat will be closed for purge, cool-down, and filling.

At the TCO end of the cryostat, there will be four penetrations for the cryogenic fluid pumps to be connected. A normally closed valve will be installed at each penetration to prevent any loss of fluid with pump maintenance or damage.

### 5.4 Cryogenics

The detector cryogenics system supplies LAr and provides circulation, re-condensation, and purification. The cryogenic system components are housed inside the CUC, on top of each detector module and between the two detector modules in each cavern. The cryogenics system comprises

- **Infrastructure Cryogenics:** this includes LAr and LN<sub>2</sub> receiving facilities on the surface, nitrogen refrigeration systems (both above ground and underground), LN<sub>2</sub> buffer storage underground, piping to interconnect equipment (LN<sub>2</sub>, GN<sub>2</sub>, and GAr), components in the detector cavern, and the CUC and process control/support equipment.
- **Proximity cryogenics:** this includes reliquefaction and purification subsystems for the argon (both gas and liquid), associated instrumentation and monitoring equipment and LAr piping to interconnect equipment and components in the detector cavern and the CUC. The proximity cryogenics are split into three areas: in the CUC; on top of the mezzanine, as shown in figure 5.8; and on the side of the cryostat where LAr circulation pumps are installed.
- **Internal cryogenics:** this includes LAr and GAr distribution systems inside the cryostat, as well as features to cool the cryostat and the detector uniformly.

Figure 5.5 shows the process flow diagram of the LBNF cryogenic system. For convenience, only one cryostat is shown. The three main areas are

1. Surface (on the left), with the receiving facilities and the recycle compressors of the nitrogen system. All these items are part of the infrastructure cryogenics.
2. CUC (in the center), with the LAr/GAr purification and regeneration systems (part of the proximity cryogenics) and the cold boxes, expanders, and LN<sub>2</sub> storage (part of the infrastructure cryogenics).
3. Detector cavern (on the right), with the argon condensing system and the distribution of argon from the purification system in the CUC to the cryostat and vice versa.

Argon and nitrogen are received and stored on the surface in the liquid phase. They are vaporized and transferred underground in the gas phase, the nitrogen as part of the nitrogen system, the argon separately.

The cryogenics system fulfills the following modes of operations:

- **Gaseous argon purge:** initially, each cryostat is filled with air, which must be removed by means of a slow GAr piston purge. A slow flow of argon is introduced from the bottom and displaces the air by pushing it to the top of the cryostat where it is vented. Once the impurities, primarily nitrogen, oxygen, and water, drop below the parts per million (ppm) level, the argon exhausted at the top of the cryostat is circulated in closed loop through the gas purification system and re-injected at the bottom. Once the contaminants drop below the ppm level, the cool-down can commence. The GAr for the purge comes directly from above ground, passes through the GAr purification and then it is injected at the bottom of the cryostat by means of a GAr distribution system.
- **Cryostat and detector cool-down:** the detector elements must be cooled in a controlled and uniform manner. Purified LAr flows into sprayers that atomize it. A second set of sprayers flowing purified GAr moves the mist of argon around to achieve a uniform cooling. The cooling power required to recondense argon in the condensers outside the cryostat is supplied by the vaporization of nitrogen from the nitrogen system. Once the detector elements reach



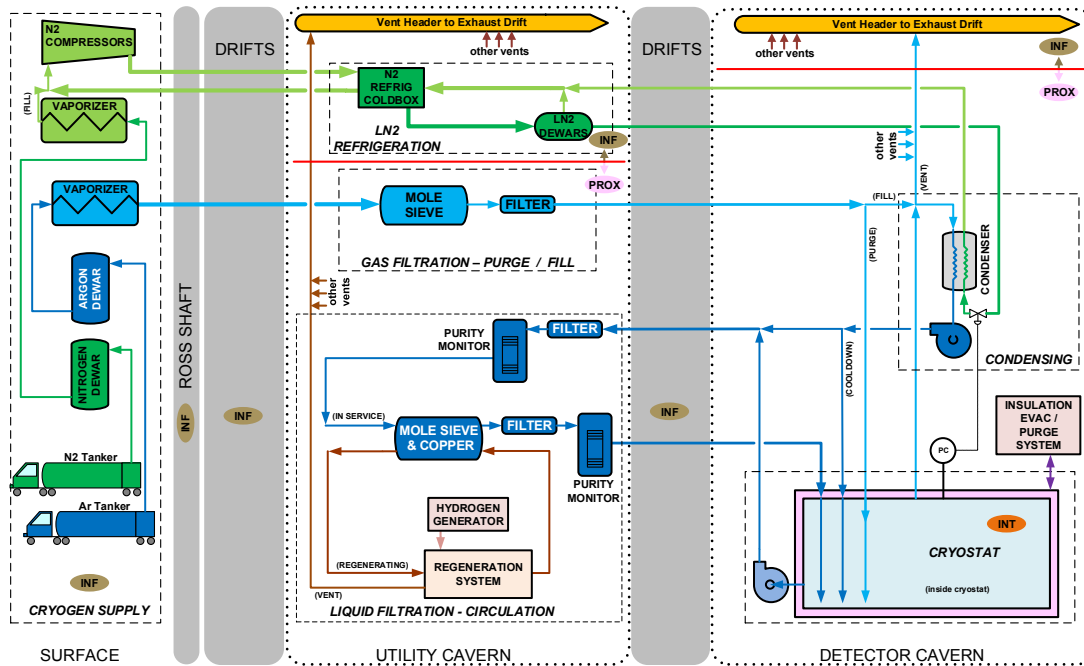

Figure 5.5. Overall process flow diagram of the cryogenic system showing one cryostat only; other cryostats are the same.

about 90 K, the filling can commence. The GAr for the cool-down comes directly from above ground, passes through the GAr purification, then is condensed in the condensers before being injected into the sprayers. The GAr moving the mist of argon around only goes through the GAr purification and not the condensers.

- **Cryostat filling:** Argon is vaporized and transferred underground as a gas from the receiving facilities on the surface. It first flows through the GAr purification system and is recondensed in the argon condensers by means of vaporization of LN<sub>2</sub>. It then flows through the LAr purification and is introduced in the cryostat. The filling of each cryostat varies in duration, from 8 to 15 months, depending on the available cooling power at each stage. With the full refrigeration system available, the filling of the fourth cryostat will take approximately 15 months.
- **Steady state operations:** the LAr contained inside each cryostat is continuously purified through the LAr purification system using the main external LAr circulation pumps. The boil-off GAr is recondensed in the argon condensers and purified as liquid in the same LAr purification system as the bulk of the LAr.
- **Cryostat emptying:** at the conclusion of the experiment, each cryostat is emptied and the LAr is removed from the system.

Each detector has its own stand-alone process controls system, which is redundant and independent of the others. It resides locally in each cavern. PLC racks are located on the mezzanine, in the pit over the protective structure of the main LAr circulation pump, in the CUC and on the surface.

A workspace on the mezzanine and a desk with two stations in the CUC are available during installation and commissioning.

Before argon is offloaded from each truck into the receiving tanks, a sample of the LAr is analyzed locally to ensure compliance with the requirements. If the specifications are met, the truck driver is given permission to offload the truck. The process is automated to reduce human error. The purity is measured before and after the purification system by custom-made purity monitors to verify correct functioning of the system.

### 5.5 Detector and cavern integration

Figure 5.6 shows the north elevation view of the detector in the cavern. The services from the CUC enter the cavern through a passage visible on the left.

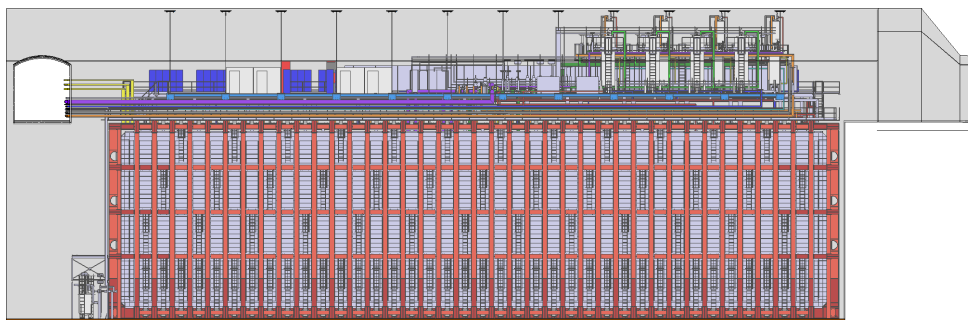

**Figure 5.6.** North elevation view of one detector module in the cavern.

Figure 5.4 shows one detector module in the cavern. In this figure, the cryogenics equipment and racks on top of the detector are visible. The LAr recirculation pumps can also be seen on the lower level. Figure 5.7 shows the west elevation view of the detector in the cavern. The services entering from the CUC are visible on the right.

Figure 5.8 shows the elevation view of the top of cryostat showing mezzanines, cryogenic equipment, and electronic racks. The cryogenics are installed on a mezzanine supported from the cavern roof and cavern wall. Cryogenic distribution lines are routed under the mezzanine. Local control rooms for the cryogenic equipment are on the mezzanine.

Detector electronics are installed in short racks close to feedthroughs and in taller racks installed on a separate electronics mezzanine shown on the left of figure 5.8. This will allow easy access for maintenance and reduce complexity on top of the detector.

### 5.6 Detector grounding

The grounding strategy provides the detectors with independent isolated grounds to minimize any environmental electrical noise that could couple into detector readout electronics either conductively or through emitted electromagnetic interference.

The detectors will be placed at the 4910L of SURF. The electrical characteristics of the various rock masses are unknown, but should have extremely poor and inconsistent conductive properties. Ensuring adequate sensitivity of the detectors requires a special ground system that will isolate the

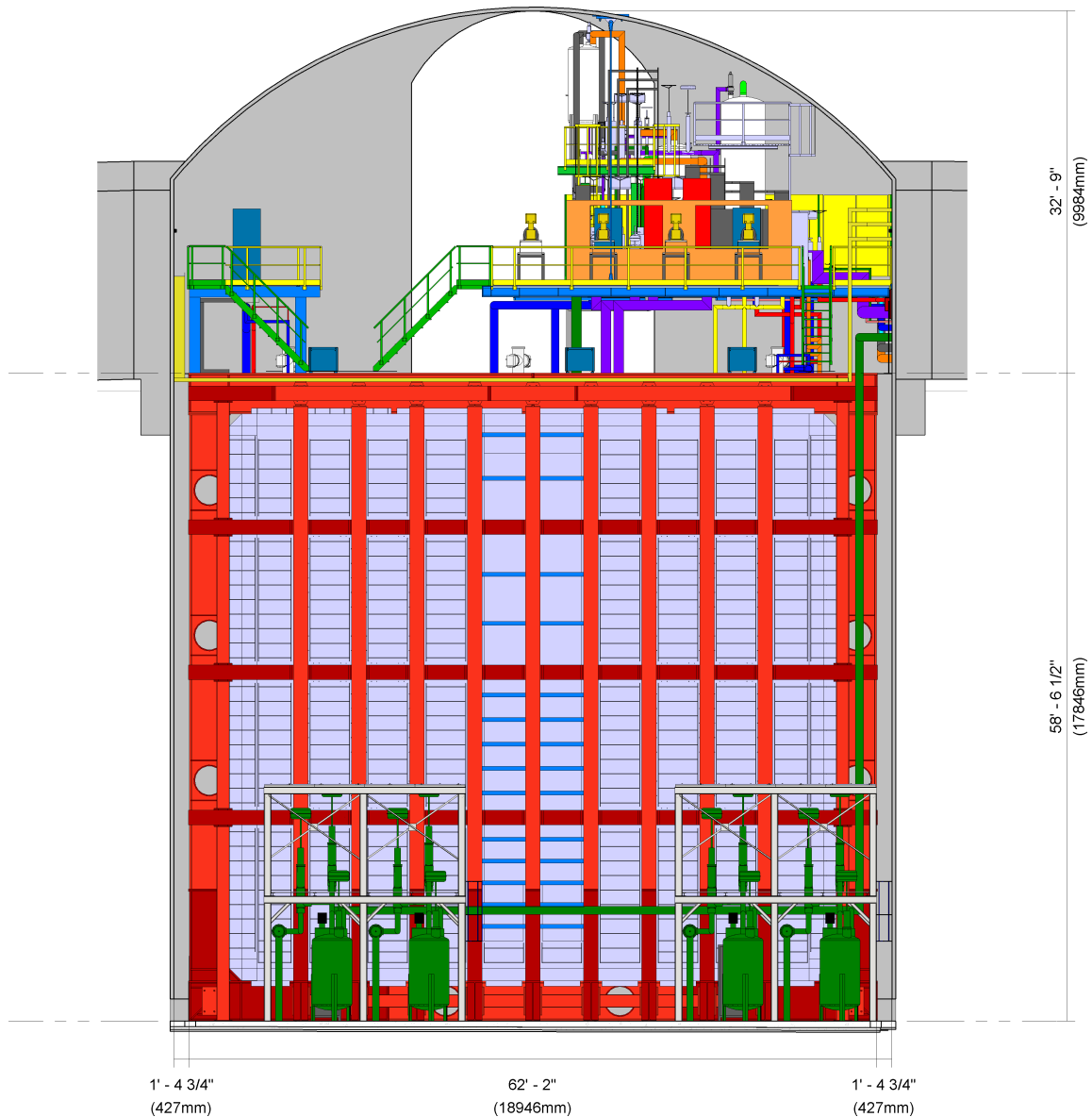

**Figure 5.7.** West elevation view of one detector in the cavern with overall dimensions.

detectors from all other electrical systems and equipment, minimize the influence of inductive and capacitive coupling, and eliminate ground loops. The grounding infrastructure should reduce or eliminate ground currents through the detector that would affect detector sensitivity, maintain a low impedance current path for equipment short circuit and ground fault currents, and ensure personnel safety by limiting any potential for equipment-to-equipment and equipment-to-ground contact.

The infrastructure grounding plan of the underground facilities is fully described elsewhere [3]. We have planned a separate detector ground, isolated from the rest of the facility, for each of the four detector modules. The detector ground will primarily comprise the steel containment vessel, cryostat membrane, and connected readout electronics. The facility ground is constructed out of two interconnected grounding structures; these are the cavern ground and the concrete encased

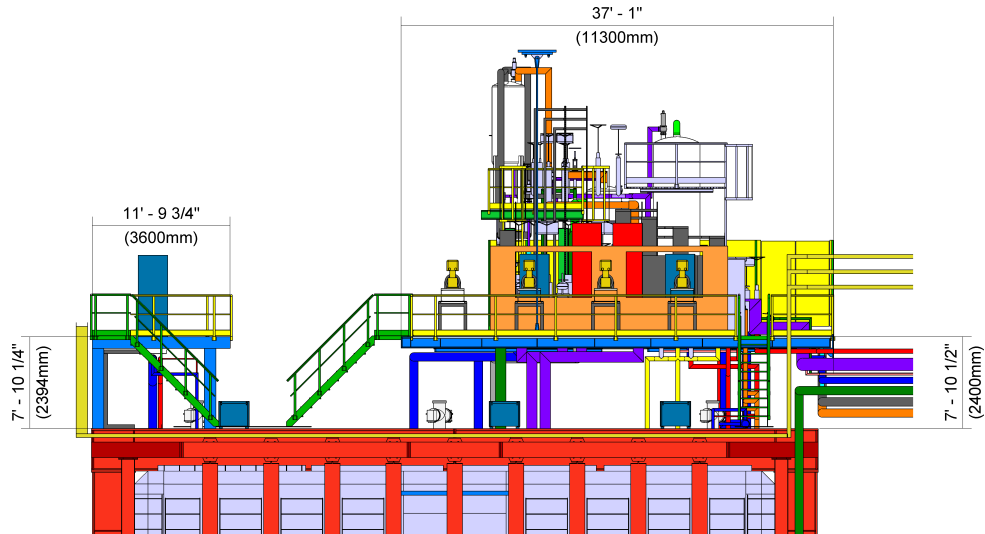

**Figure 5.8.** Elevation view of top of cryostat showing mezzanines, cryogenics equipment, and electronic racks.

electrode (Ufer) grounds which are described below. For safety reasons, a saturable inductor will connect the detector ground to the facility ground.

Figure 5.9 shows the areas of construction for the cavern and Ufer grounds.

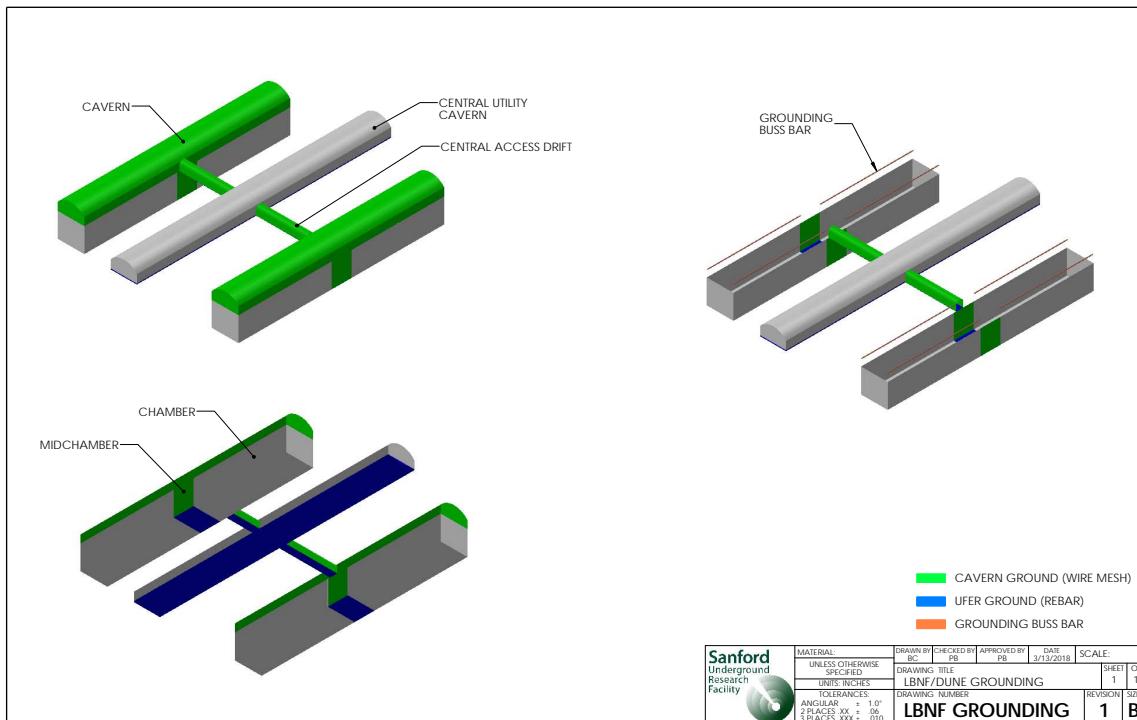

**Figure 5.9.** Overall DUNE facility grounding structure incorporated in cavern.

2020 JINST 15 T08009

Grounding structure definitions include

1. Cavern ground consisting of overlapping welded wire mesh supported by rock bolts and covered with shotcrete. The LBNF/DUNE cavern ground includes all walls and crown areas above the 4850L in the north and south detector caverns and their associated central access drifts, as well as tin-plated copper bus bars that run the length of the detector vessels on each side along the cavern walls and are mounted external to the shotcrete. The cavern ground structure
  - (a) spans the full length of the cavern from the west end access drift entrance through the mid-chamber to the east end access drift entrance;
  - (b) spans the full width of the cavern from the 4850L sill (top of the detector vessels and mid-chamber floor) on both sides up and across the crown of the cavern;
  - (c) includes mid chamber walls to the 4910L; and
  - (d) includes the east and west end walls of the cavern, from the 4850L to the crown.
2. Ufer ground consisting of metal rebar embedded in concrete floors. The LBNF/DUNE Ufer ground system includes the concrete floors in the cavern mid-chambers, center access drifts, and CUC. The cavern and Ufer grounds will be well bonded electrically to construct a single facility ground isolated from detector ground.
3. Detector ground consisting of the steel containment vessel enclosing the cryostat and all metal structures attached to or supported by the detector vessel.

To ensure safety, a safety ground with one or more saturable inductors will be installed between the detector ground and the electrically bonded Ufer and cavern grounds that form the facility ground. Figure 5.10 illustrates the use of the safety ground. The safety ground inductors saturate with flux under low-frequency high currents, presenting minimal impedance to these currents. Thus, an AC power fault current would be shunted to the facility ground and provide a safe grounding design. At higher frequencies and lower currents, such as coupled noise currents, the inductor provides high impedance, restricting current flow between grounded metal structures. The desired total impedance between the detector ground structure and the cavern/Ufer ground structure should be a minimum of 10 Ohms at 10 MHz.

As stated above, the detector ground exists only in the area of the steel containment vessel enclosing the cryostat and all metal structures attached to or supported by the detector vessel. All signal cables that run between the detector and the DAQ underground processing room in the CUC will be fiber optic. All connections to the cryogenics plant on the facility ground will be isolated from the cryostat with dielectric breaks. A conceptual drawing showing the isolation of the cryostat is presented in figure 5.11.

The construction of the facility ground provides a low impedance path for return currents of the facility services, such as cryogenic pumps, and noise coupling from facility services will be greatly reduced or eliminated. The experiment has also been carefully designed such that facility return currents will not flow under the cryostats.

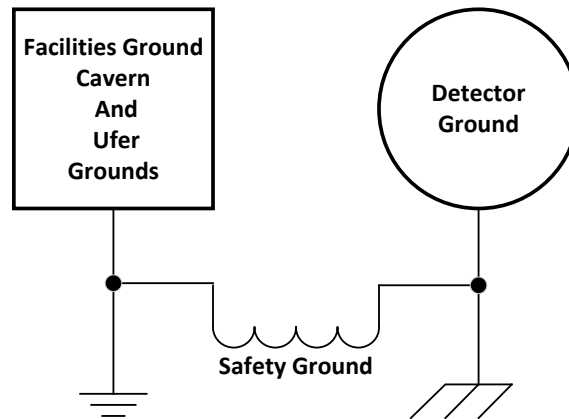

Figure 5.10. Simplified detector grounding scheme.

The cryostat itself is treated as a Faraday cage. Any connections coming from facilities outside of actual detector electronics are electrically isolated from the cryostat. For detector electronics, specific rules for signal and power cables penetrating the cryostat exist [4].

## 5.7 Detector power

After requirements were given to FSCF, limits were established on the size of the cavern excavation, cooling capabilities, and electronics power consumption. The DUNE detector modules must stay within these limits. Of the available 360 kW per module, the SP module (DP module) will only use 216(253) kW, leaving a margin of 40%(30%).

The FSCF will supply a 1000 kVA transformer for each cavern. Each cavern will host two DUNE detector modules. Power from this initial transformer will be de-rated with no more than 75% of total power available at the electrical distribution panels. We plan for a maximum consumption of 360 kW per detector module.

Figure 5.12 summarizes estimated detector loads of the DUNE electronics located in the detector caverns. The DAQ power is described at the end of this section.

The TPC electronics readout dissipates an estimated maximum of 360 W per APA. An additional 20 W will be consumed due to power loss in the cables. The low-voltage power supplies have a controller that adds approximately 35 W per APA, and supplies have an efficiency of approximately 85%. This adds up to about 488 W per APA, or a total load of 73 kW per detector module. The APA wire-bias power supplies have a maximum load of 465 W per set of six APAs, for a total budget of around 12 kW. Cooling fans and heaters near the feedthroughs will use a small amount of power, so the overall power budget for TPC electronics is expected to be less than 90 kW.

The photon detection system (PD system) electronics is based on the Mu2e (DAPHNE) electronics, from which we estimate a total power budget of approximately 6 kW. DUNE plans a slightly higher power budget of 8 kW to account for cable and power supply inefficiencies. The PD system electronics presents a significantly lower power load than the SSP alternative solution used in ProtoDUNE-SP, which requires a power budget of approximately 72 kW per detector module.

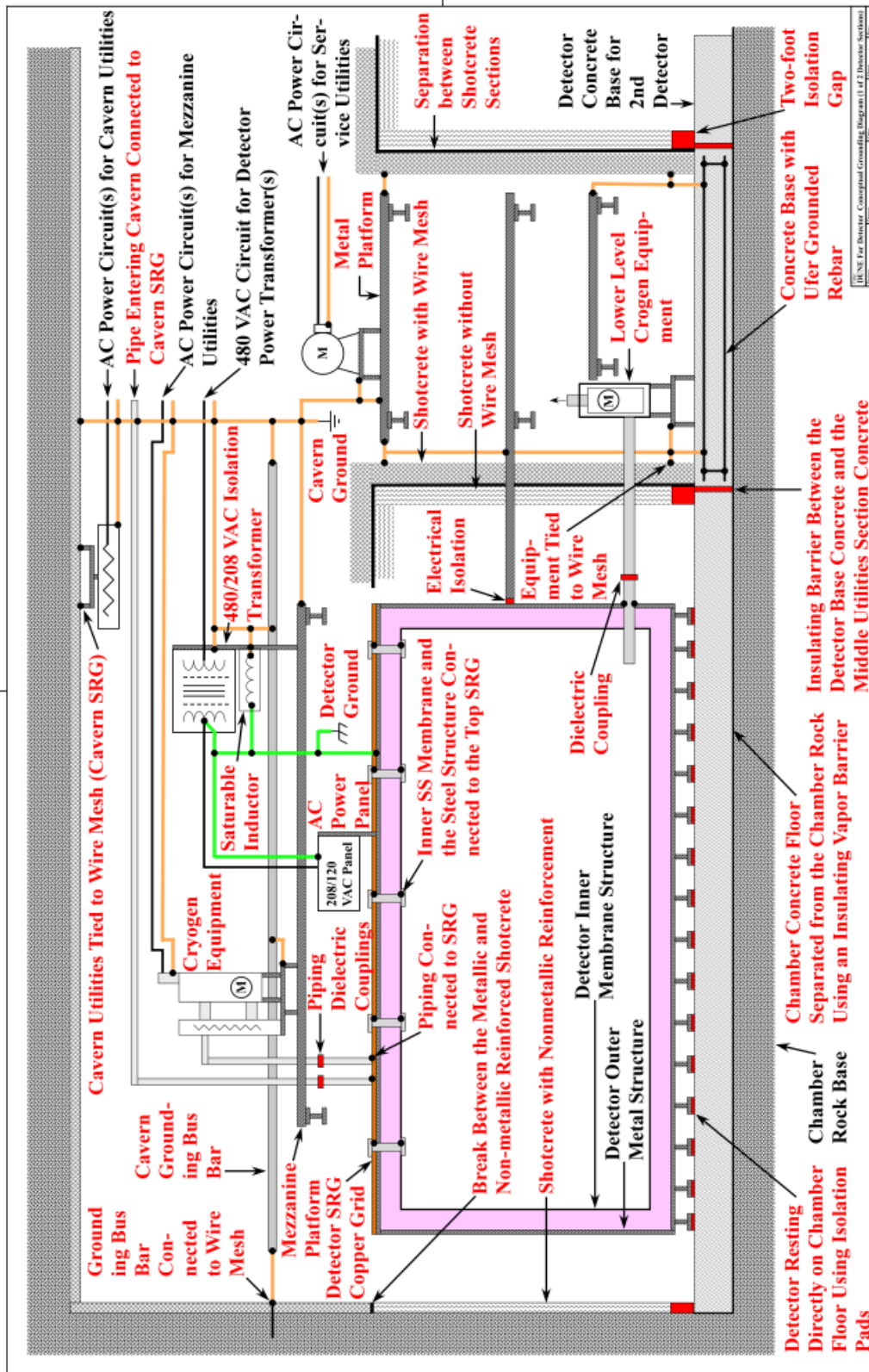

Figure 5.11. Schematic of detector grounding system.

<b>DUNE Detector Electronics - Estimated Power Consumption</b>			
	<b>Load (kW)</b>	<b>loss due to cables and control (kW)</b>	<b>Total Power (85% efficient supplies) (kW)</b>
<b>DUNE - SP</b>			
Cold Electronics	73	4	90
Photon Detector	6	0.5	8
HV Drift	0.06		1
Rack Infrastructure	40	4	52
Cryogenic Instrumentation	50	5	65
<b>TOTAL</b>			<b>216</b>
<b>DUNE - DP</b>			
TPC Electronics	160	16	176
HV Drift	0.15		1
Rack Infrastructure	10	1	11
Cryogenic Instrumentation	50	5	65
<b>TOTAL</b>			<b>253</b>

**Figure 5.12.** DUNE estimated power consumption.

Each of the approximately 80 detector racks will have fan units, Ethernet switches, rack protection, and slow controls modules, adding a load of about 500 W per rack, bringing the total to 40 kW.

Twenty-five racks are reserved for cryogenics instrumentation with a per-rack load conservatively estimated at 2 kW, for a total of 50 kW.

The SP detector module will thus use an estimated 216 kW of power. The higher-load SSP alternative for the PDS would increase this to 280 kW. This higher estimate represents approximately 60–78% of our available power.

The dual-phase (DP) electronics estimate is approximately 253 kW and also fits well within the planned maximum of 360 kW.

For the SP module, the power will be largely distributed to a number of detector racks that will sit on a detector rack mezzanine above the cryostat. Each of the racks will receive a 30 A 120 V service, with a maximum of 80 racks.

The other area where DUNE requires power underground is in the DAQ room. There the power budget is determined by the available 750 kVA transformer. The available power must be de-rated to 80% at the electrical distribution panel and another 80% for equipment efficiency. Thus, 480 kW of power will be distributed to a maximum of 60 racks. Each water-cooled rack will have approximately 8 kW available for computing power.

A minimal level of UPS power will be provided to the DAQ equipment to allow for powering down servers. Cryogenic controls and any critical safety interlocks will have access to long term UPS back-up. At this time, no UPS power is being proposed for detector readout electronics.



## 5.8 Data fibers

The DUNE experiment requires a number of fiber optic pairs to run between the surface and the 4850L. A total of 96 fiber pairs, which accommodates both DUNE and LBNF needs, will be supplied through redundant paths with bundles of 96 pairs coming down both the Ross and Yates shafts. The individual fibers are specified to allow for transmission of 100 Gbps. A schematic view of the fiber paths from surface to underground is shown in figure 5.13. From the surface main communications room (MCR, the surface DAQ room), we will connect to the WAN and ESnet as described in section 5.10, which is being designed by FSCF and the Fermilab networking groups.

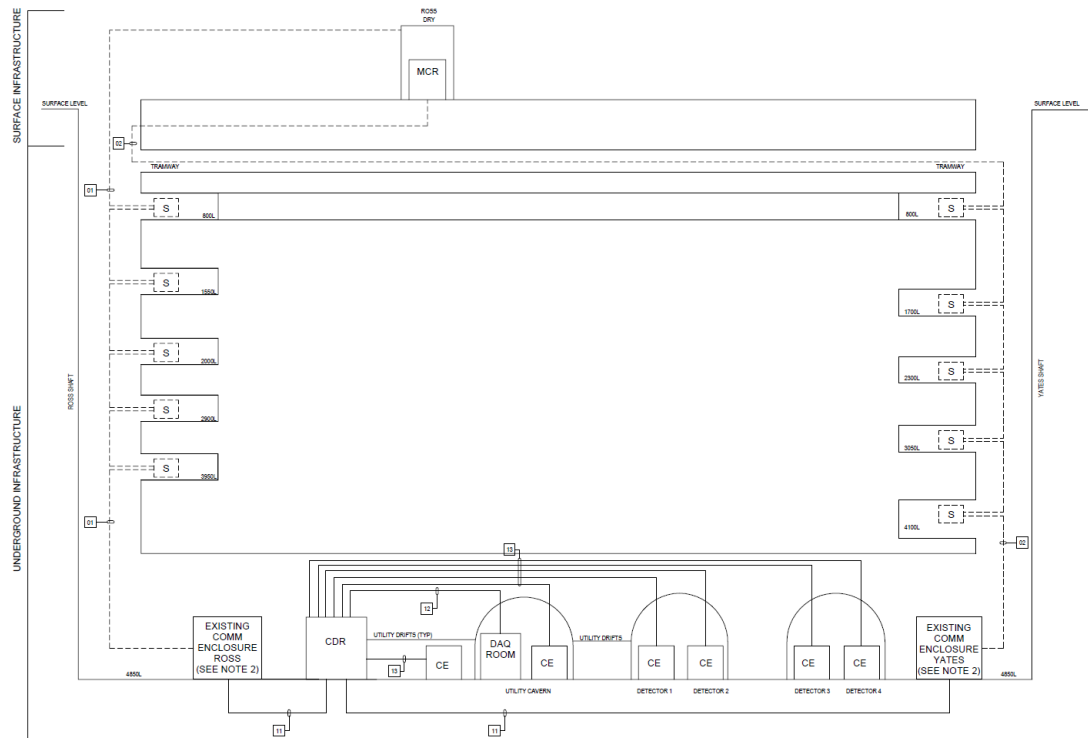

**Figure 5.13.** Schematic of detector fiber path.

The redundant fiber cable runs of 96 fiber pairs are received in existing communications enclosures at the 4850L entrances of the Ross and Yates shafts. The two 96 fiber pair bundles are next routed to the CDR. The fibers will be received and terminated in an optical fiber rack. Two additional network racks will be used to route the fiber data between the surface and underground.

The plan is to use only the Ross Shaft set of 96 fiber pairs with the Yates set being redundant. The network switches will allow for switchover in case of catastrophic failure of fibers in the Ross shaft. There is a very low risk of catastrophic failure, but it could occur if, for instance, rock fell and damaged the fibers. The Yates path is viewed as a hot spare. Plans are being formed to periodically test the redundant Yates path and verify its viability.

From the CDR, fibers designated for FSCF are routed to provide general network connections to the detector caverns, CUC, and the underground DAQ room.

A total of 96 fiber pairs are routed to the underground DAQ room for use by the DUNE experiment and LBNF. The fibers are reserved as follows:

- 15 pairs for DUNE data per detector-total 60 pairs,
- 1 pair for slow controls per detector-total 4 pairs,
- 2 pairs reserved for Global Positioning System (GPS),
- 6 pairs for FSCF,
- 4 pairs for LAr cryogenics,
- 4 pairs for LN<sub>2</sub> cryogenics, and
- 16 pairs reserved as spares.

The set of reserved fiber pairs total to 80.

### 5.9 Central Utility Cavern Control and DAQ Rooms

The CUC contains various cryogenic equipment and the DAQ and Control Room for the DUNE experiment. The cryogenic system and areas are described in section 5.4. Both the control and DAQ rooms are at the west end of the CUC (see figure 5.14).

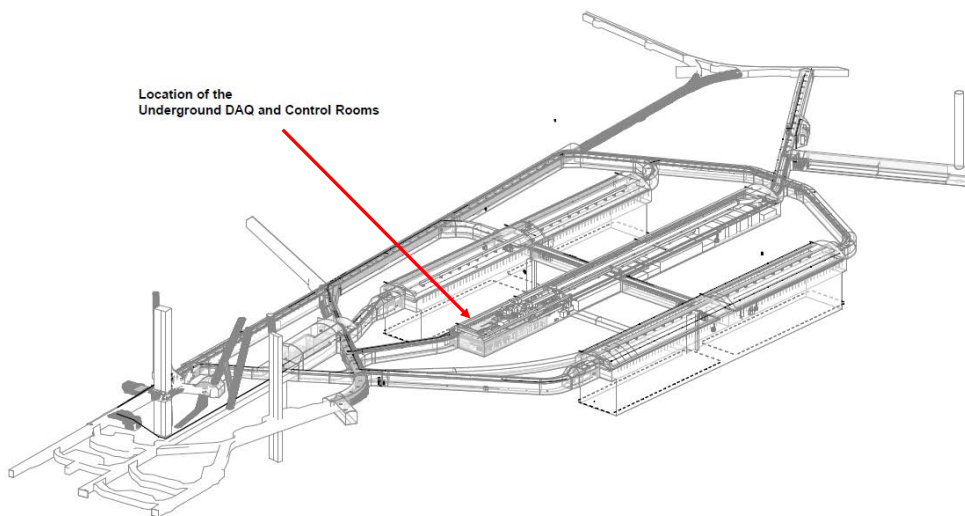

**Figure 5.14.** Location of underground DAQ and control room in the CUC.

The control room is an underground space of approximately 18 x 48 feet and serves multiple purposes. It provides a meeting or work space during system commissioning. It provides easy access to DAQ equipment for debugging and service during commissioning. During experimental operations, the DUNE experiment will have a remote control room located at Fermilab's main campus.

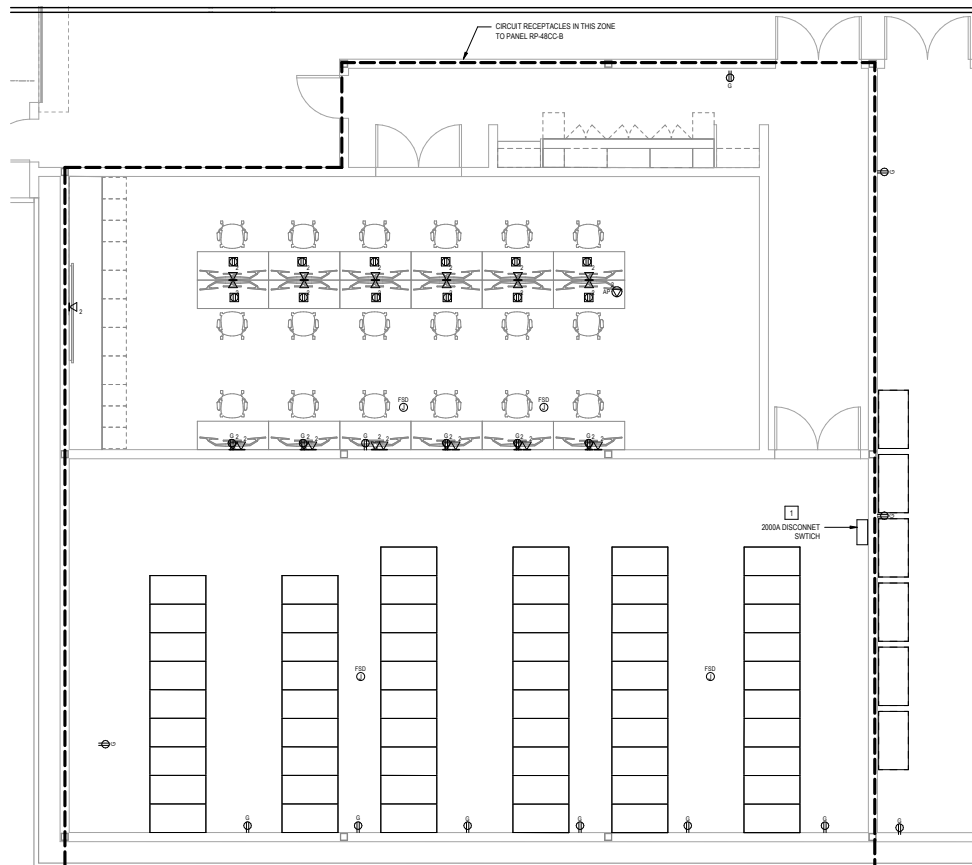

**Figure 5.15.** Underground DAQ and control room layout.

Figure 5.15 shows the layout and suggested outfitting of the rooms. Additionally, the control room provides the required workstation for monitoring of Fire and Life Safety and the building management system. These are facility services for which DUNE is not directly responsible, but the experiment will need to interface with these systems. One example of this interface would be the reporting of any smoke detected within a detector rack.

Lastly, the cryogenic team requires a space allocation within the Control Room of two racks and two work benches for the technicians who monitor the cryogenic systems. This space is needed only during commissioning with remote operation to follow. Additional space for cryogenics commissioning may be available on the mezzanines.

The DAQ room is approximately  $26 \times 56$  square feet and will contain 52–60 racks that will be used for fiber optic cable distribution, networking, DUNE DAQ and two or three racks for conventional facilities. The current design, shown in figure 5.16, shows a total of 60 racks possible.

A quantity of 48 racks are reserved exclusively for DAQ. Two additional racks are required for optical fiber distribution and network connection to the surface.

The FSCF will supply the DAQ room with cooling water, a 46 cm (18 inch) raised floor, lighting, HVAC, dry fire protection and a dedicated 750 kVA transformer. The integration office has responsibility for installing the remaining infrastructure which includes water cooled racks, the piping required to distribute water to the racks, the electrical distribution system required to provide AC power for the racks, and supporting cable trays.

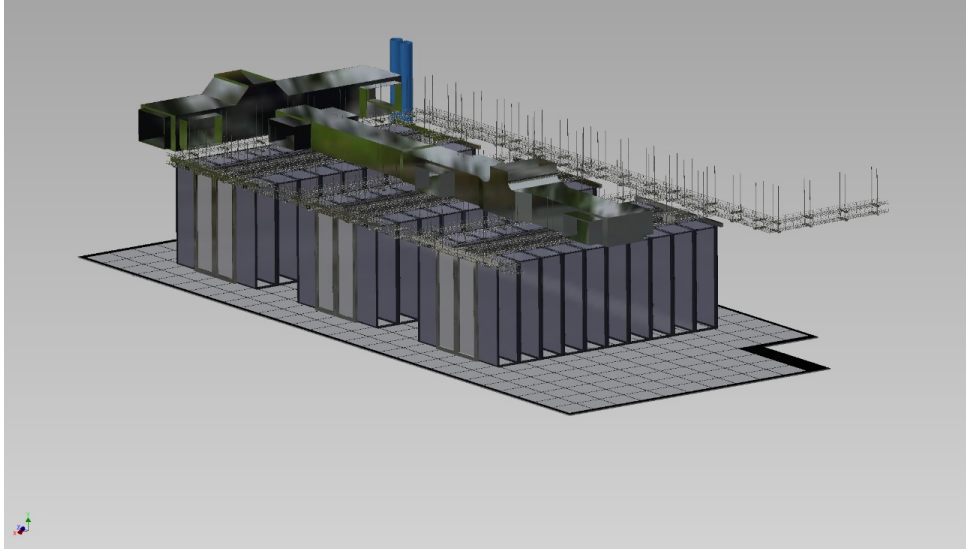

**Figure 5.16.** Proposed rack layout in DAQ room.

## 5.10 Surface rooms

The DUNE experiment requires space on the surface for a small number of DAQ, networking, and fiber optic distribution racks. Space is also allocated for cryogenics. The surface cryogen building and operations is described in section 5.4.

The DAQ consortium requires a surface computer room with eight racks and a minimum of 50 kVA of power. DAQ also requires connection to the optical fibers running to the 4850L via the Ross and Yates shafts as well as to the Energy Sciences Network (ESnet).

The surface DAQ, networking equipment, and fiber distribution racks will be placed in a new main communications room (MCR) in the Ross Dry building. The MCR is approximately 628 square feet and will be completed as part of the LBNF project, with seven racks installed for the conventional facilities and space allocated for eight racks provided by the experiment. The seven racks allocated for conventional facilities will include networking and fiber optic distribution. The eight racks allocated to the experiment will contain computer servers, disk buffer, and some network connections. Power and cooling will be provided as part of the LBNF project.

## 5.11 DUNE detector safety system

The DUNE detector safety system (DDSS) functions to protect experimental equipment. The system must detect abnormal and potentially harmful operating conditions. It must recognize when conditions are not within the bounds of normal operating parameters and automatically take pre-defined protective actions to protect equipment. Protective actions are hardware or PLC driven.

DUNE technical coordination works with the consortia to identify equipment hazards and ensure that harmful operating conditions can be detected and mitigated. These hazards include smoke detected in racks, leak(s) detected in water cooling areas, oxygen deficiency hazard (ODH) detection, a drop in the cryostat LAr liquid level, laser or radiation hazards in calibration systems,

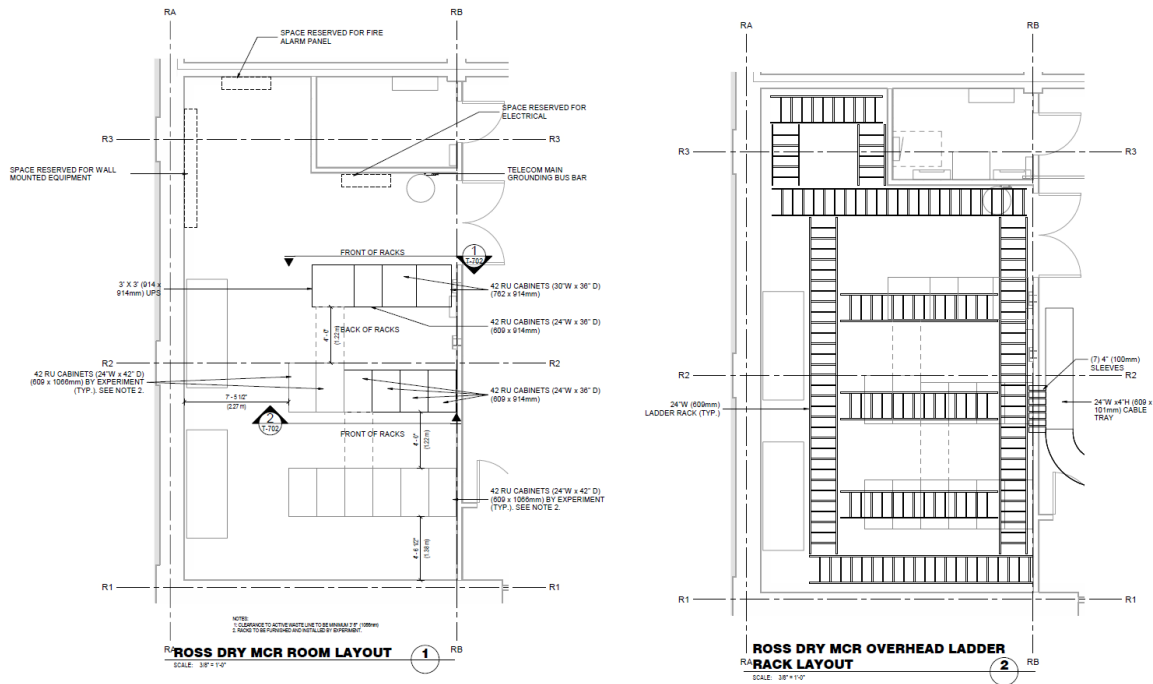

Figure 5.17. Ross area surface rooms layout.

over or under voltage conditions, and others to be determined. Some hazards will be unique to the actual detector being implemented.

The slow controls system plays an active role and collects, archives, and displays data from a broad variety of sources and provides real-time status, alarms, warnings, and hardware interlock status for the DDSS and detector operators. Slow controls monitor operating parameters for items such as HV systems, TPC electronics, and photon detector (PD) systems. Data is acquired via network interfaces, and status and alarm levels will be sent to the DDSS. Safety-critical issues that require a hardware interlock, such as smoke detection or a drop in the LAr level, which could cause high voltage (HV) damage to components, are monitored by slow controls; interlock status is provided to the DDSS. The protective action of a safety critical issue is done through hardware interlocks and does not require the action of an operator, software, or PLC.

The DDSS will provide input to the 4850L fire alarm system. The 4850L fire alarm system will provide life safety and play an integral role in detecting and responding to an event as well as notifying occupants and emergency responders. This system is the responsibility of the host laboratory and SDSTA. The fire alarm system is described in the BSI design [5]. The 4850L fire alarm system is connected to the surface incident command vault in the second floor of the Yates Administration building. Limits on the number of occupants and egress paths are discussed. The table of triggering inputs and Fire Alarm Sequence of Operation is documented in the set of BSI underground electrical drawings, sheet U1-FD-E-308, which is also found in [5]. The experiment will be adding a list of initiating inputs, such as smoke detected in electronic racks or water leaks detected in the DAQ room to this sheet as designs reach a higher level of maturity.

The DDSS must communicate to the DUNE slow controls system as well as the 4850L fire alarm system. The DUNE slow controls system monitors and records detector status. Working together through communication links, the three systems will (1) monitor the status of the experiment (slow controls), (2) protect equipment (DDSS), and (3) and provide life safety (4850L fire alarm system). Figure 5.18 indicates how these systems interact.

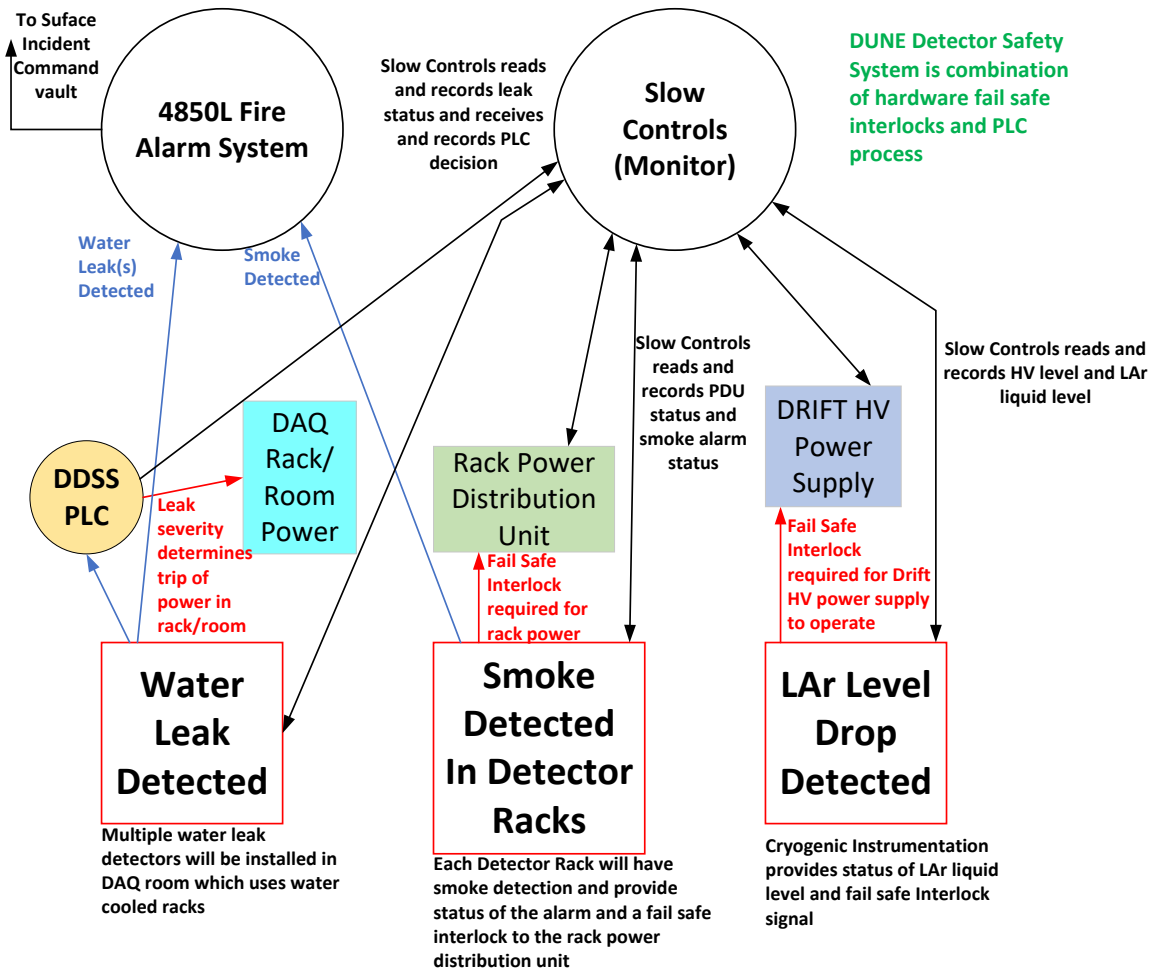

Figure 5.18. Sample DDSS information flow.

The DDSS will be implemented through robust sensors feeding information to redundant PLCs that activate hardware interlocks. The selection of the PLC hardware platform is still an open decision. Listed below are some of the general DUNE experimental conditions that require intervention of the DDSS:

1. A drop in the LAr level. This condition requires a hardware interlock on the liquid level. If the level drops below a pre-determined level, the drift HV must automatically be shut off to prevent equipment damage due to HV discharge. Slow controls would be alerted through normal monitoring and record the status of the detector.

2. Smoke or a temperature/humidity increase above normal operating levels. This could be detected inside a rack or near an instrumented feedthrough. If any of these conditions are detected, local power must be automatically switched off. If smoke is detected, a dedicated line will alert 4850L fire alarm system.
3. A water leak detected near energized equipment in the DAQ underground data processing room. Water leak detectors report to the DDSS PLC and a decision will be made to either issue an alert or immediately shut down power to the room, depending on the detected magnitude of the leak. This condition would also be reported to the 4850L fire alarm system.

## Chapter 6

# DUNE detector construction management

This chapter provides an overview of the DUNE FD modules and their construction management. The FD will have approximately 70 kt of LAr mass divided into four cryostats. Each detector module is contained in its own 17.5 kt cryostat, of which at least 10 kt of the LAr is active (fiducial). DUNE has two detector designs: SP and DP. Full descriptions can be found in Volume IV and Volume V of this FD TDR.

### 6.1 DUNE single-phase far detector module

The SP LArTPC is a 10 kt module, contributing to the full 40 kt FD fiducial mass. One 10 kt SP module is shown in figure 6.1.

The module is contained in a cryostat as shown in figure 5.4. Four drift volumes are created between alternating APA and CPA walls on sides, field cages (FCs) and ground planes (GPs) on top and bottom, and two endwall field cages (endwall FCs). Each drift volume is 58.2 m long, 3.5 m wide and 12.0 m high. The entire assembly is supported from the roof of the cryostat with DSS.

Each of the three APA walls consists of an array of 25 wide and 2 high individual APAs, each with dimensions of 6.2 m high and 2.32 m wide. There are 150 APAs in one module. Each APA contains 10 PDs. Each of the two CPA walls consists of an array of 25 wide and 2 high CPA panels. Two panels are stacked to form planes, each with dimensions of 12.1 m high and 1.16 m wide. There are 100 CPAs in one module. CPA walls are held at  $-180$  kV. With APA walls held close to ground, the result is a 511 V/cm gradient across the drift volume. The drift in the SP module is in the horizontal direction. The LAr level is above the top set of GPs and just below the DSS.

Readout electronics are mounted on the APAs. Cables from the readout electronics and PD systems are routed to the cryostat roof where they exit through a set of 75 feedthroughs. The cables are connected to warm interface boards (WIBs), which are contained in 150 warm interface electronics crates (WIECs) for APAs and 75 crates for PD systems. Data fibers from the WIECs carry the data to DAQ racks inside the CUC.

There are four HV feedthroughs on top of the cryostat, two on each end. In addition, there are feedthroughs for calibration, instrumentation and cryogenics distribution. Power supplies, and



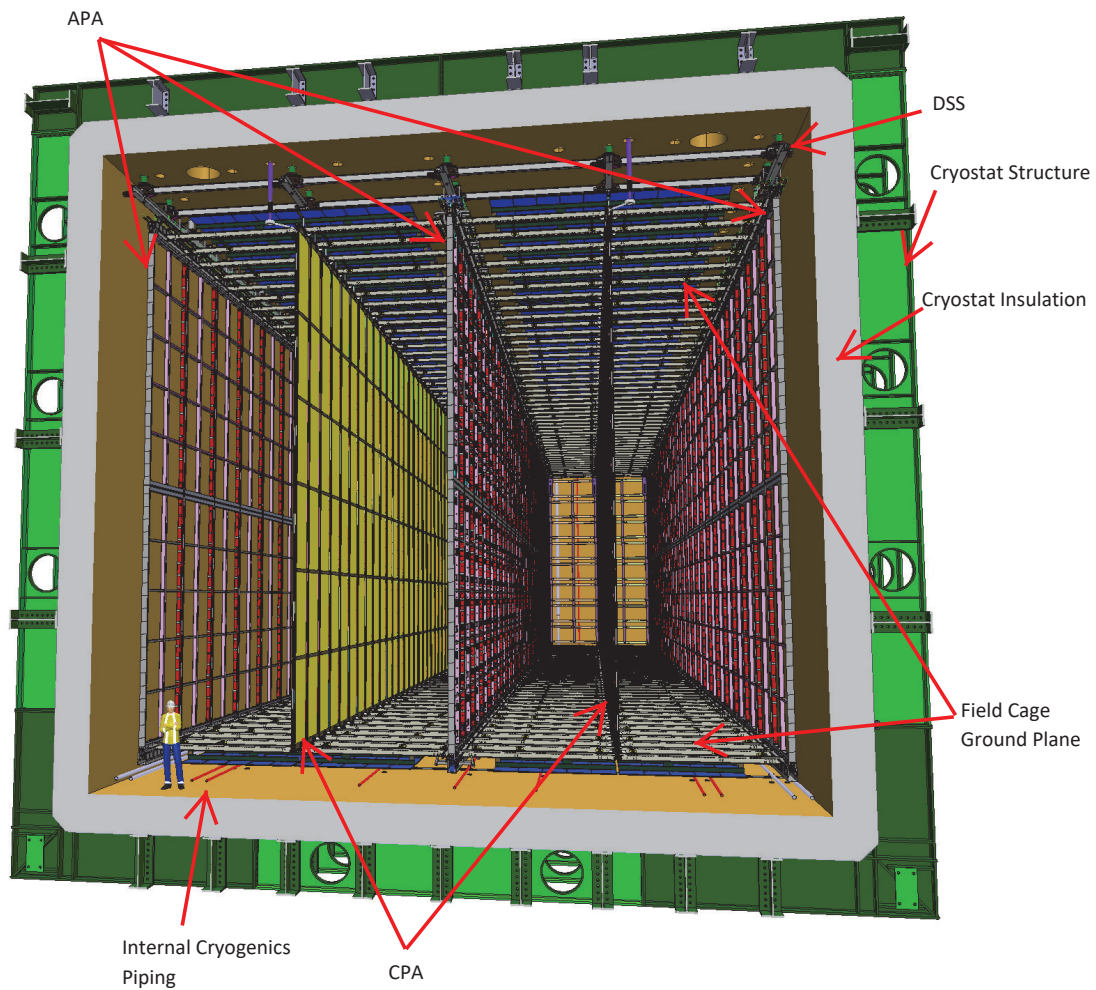

**Figure 6.1.** A 10 kt DUNE FD SP module, showing alternating APAs, CPAs, FC and ground planes, detector support system, cryostat and cryogenics distribution.

controls are located on top of the cryostat on a dedicated mezzanine. Cryogenics equipment is also installed on a separate mezzanine on top of the cryostat.

## 6.2 DUNE dual-phase far detector module

Each DP module is a 10 kt LArTPC, contributing to the full 40 kt FD fiducial mass. One 10 kt DP module is shown in figure 6.2.

Each DP module is contained in a cryostat with the same internal dimensions as the SP module, but with some variations in cryostat penetrations. The DP module consists of a single drift volume with a vertical drift direction.

The drift volume is enclosed on the top by an array of 80 charge-readout planes (CRPs), on the bottom by cathode planes and on the perimeter by a FCs. It is 12.0 m in height with a 500 V/cm gradient. The cathode is held at a potential of  $-600$  kV. The DP PD system consists of 720

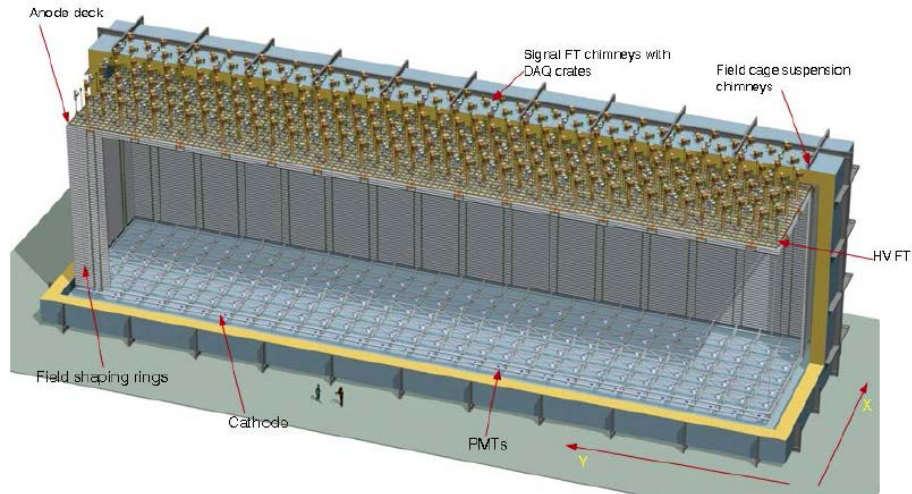

**Figure 6.2.** A 10 kt DUNE DP module.

photomultiplier tubes (PMTs) at the bottom of the drift volume and is integrated with the cathode planes. The LAr level in DP module is within the CRP, just above the collection grid and below the anode readout plane. A gradient of 2 kV/cm in this region is used to extract the drift electrons from the liquid. A large electron multiplier (LEM) with a gradient of 33 kV/cm causes charge multiplication and amplification of the charge that is then collected on the anode, which consists of two perpendicular readout strips.

The DP DSS consists of a set of stainless steel cables that are suspended from feedthroughs on top of the cryostat. The cables can be extended to the floor of the cryostat where they are used to lift components to design height. In the case of CRPs, there are three cables per panel with active height control in order to position the panel precisely with respect to the LAr surface.

The cryogenic front-end (FE) electronics is installed in the signal feedthrough chimneys (SFT chimneys) on the roof of the cryostat to process the LArTPC signals. Each SFT chimney is coupled to a Micro Telecommunications Computing Architecture ( $\mu$ TCA) crate to digitize the signals. These crates are connected via optical fiber links to the DAQ back end. Arrangement of equipment on top of the cryostat is similar to the SP module.

### 6.3 DUNE far detector consortia

A total of eleven FD consortia have been formed to cover the subsystems required for the two detector types currently under consideration. In particular, three consortia (SP-APA, SP-TPC Electronics and SP-Photon Detection) pursue subsystems specific to the single-phase design and another three consortia (DP-CRP, DP-TPC Electronics, and DP-Photon Detection) pursue designs for DP specific subsystems. An additional five consortia (HV System, DAQ, cryogenic instrumentation and slow controls (CISC), Calibration, and Computing) have responsibility for subsystems common to both detector technologies. Figure 6.3 shows the consortia associated with the FD construction effort along with their current leadership teams.

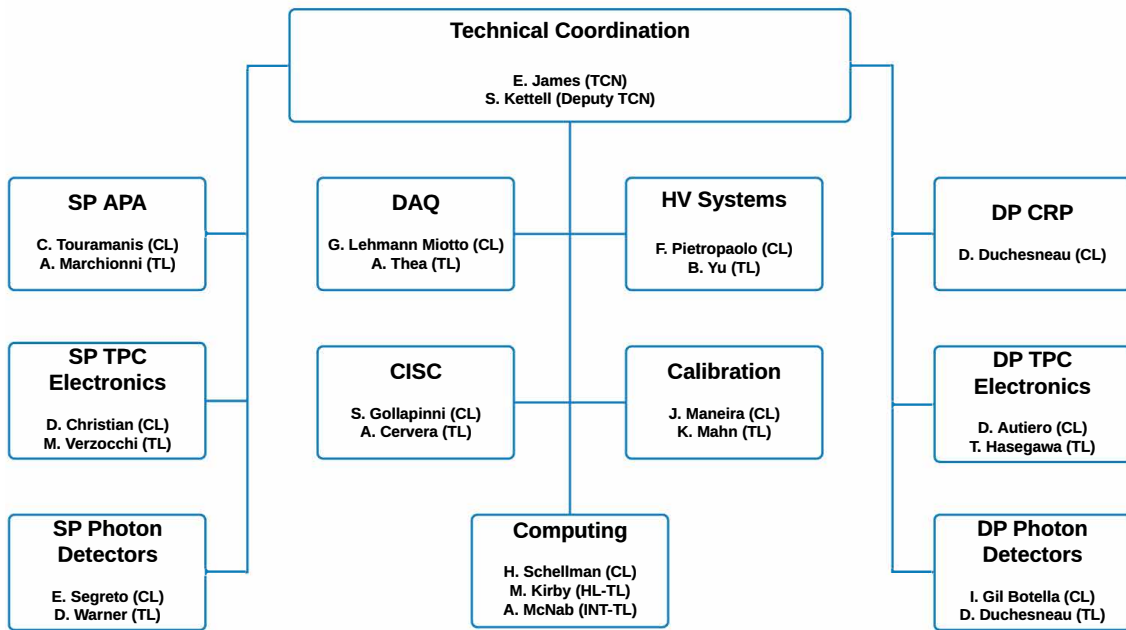

**Figure 6.3.** DUNE consortia organization. CL refers to consortium leader and TL refers to technical lead.

#### 6.4 Work Breakdown Structure (WBS)

The complete scope of the DUNE construction project is captured in a work breakdown structure (WBS) to explain the distribution of deliverables between the consortia. In combination with interface documentation, the WBS is used to validate that all necessary scope is covered. The WBS is also used as a framework for building DUNE detector cost estimates.

The highest-level layers of the DUNE WBS are summarized in figure 6.4. At level 1 the WBS is broken down into six elements corresponding to the five DUNE detector modules (four FD and one near detector (ND)) and technical coordination. The scope documented here is fully contained within the technical coordination, first FD module (SP), and second FD module (DP) level 1 elements.

For the FD module elements at level 1, the WBS breaks down at level 2 into elements encompassing the deliverables provided by each consortium to that detector module along with an element containing common deliverables associated with the required detector installation and integration effort. Since each consortium takes responsibility for a particular subsystem, this breakdown effectively corresponds to a division of deliverables across subsystems.

The level 3 breakdown of the level 2 subsystem WBS elements follow a common format that separates required activities into groupings defined roughly by their sequence in time. A total of six elements are used:

1. management,
2. physics and simulation,
3. design, engineering, and R&D,

WBS	WBS name
	<b>DUNE</b>
1	DUNE Technical Coordination (TC)
2	Single Phase Far Detector (DUNE-SP)
2.1	SP Installation (SP-Install)
2.2	SP Anode Plane Assemblies (SP-APA)
2.3	SP TPC Electronics (SP-ELE)
2.4	SP Photon Detection System (SP-PD)
2.8	High Voltage System (SP-HVS)
2.9	DAQ (SP-DAQ)
2.10	Cryogenic Instrumentation & Slow Control (SP-CISC)
2.11	Calibration (SP-CAL)
3	Dual Phase Far Detector (DUNE-DP)
3.1	DP Installation (DP-Install)
3.5	Charge Readout Plane (DP-CRP)
3.6	DP TPC Electronics (DP-ELE)
3.7	DP Photon Detection System (DP-PD)
3.8	High Voltage System (DP-HVS)
3.9	DAQ (DP-DAQ)
3.10	Cryogenic Instrumentation & Slow Control (DP-CISC)
3.11	Calibration (DP-CAL)
4	Reserved for future far detectors
5	Reserved for future far detectors
6	Reserved for near detector

Figure 6.4. High level DUNE WBS to level 2.

4. production setup,
5. production, and
6. integration and installation.

The groupings at level 3 allow for the convenient separation of costs including those associated with one-time and recurring activities in the case where two identical detector modules are constructed.

Lower levels within these WBS elements are determined by the responsible consortia and generally correspond at level 4 to the different primary detector components from which each subsystem is assembled. This level 4 structure is repeated under each of the level 3 items to ensure that the full cost of each primary detector components can be rolled up over the sequence of activities defining their design, production, and installation.

## 6.5 DUNE design maturity

The DUNE project builds on significant development in previous large LArTPC detectors (ICARUS and MicroBooNE) and on substantial development from LBNE and Long Baseline Neutrino Observatory (LBNO). One of the most important elements that has significantly advanced the project

development is the successful construction of the ProtoDUNE detectors and successful operation of ProtoDUNE-SP. These detectors use full-size DUNE components and processes. The construction of ProtoDUNE has established teams, production lines, QA and QC processes, installation, operation, and performance of the final DUNE detectors.

Based on the success of ProtoDUNE, DUNE has reached advanced technical maturity, approaching (80%). The designs from ProtoDUNE have significantly advanced for the DUNE FD. Most subsystems completed preliminary design review or 60% reviews on design modifications beyond ProtoDUNE in advance of the TDR. The overall level of design maturity is now ~ 90%. The breakdown of the design maturity level for the SP module by subsystem is provided in table 6.1. The table shows the DUNE design maturity at the time of ProtoDUNE-SP and at the time of writing of this TDR, along with the estimated design effort or weight of each subsystem.

**Table 6.1.** SP module design maturity.

System	Weight	ProtoDUNE	DUNE
DSS	10%	75%	85%
APA	30%	85%	95%
TPC Electronics	20%	80%	90%
PDS	10%	50%	65%
HVS	15%	80%	95%
DAQ	10%	60%	80%
CISC	5%	80%	90%
Total	100%	76%	90%

In particular for the SP design:

- The APA conceptual design was developed in 2010, prototyped first at 40% scale, and again in the 35 ton prototype. The version deployed in ProtoDUNE-SP is close to that for the SP module (85%).
- The TPC electronics low-noise system design, including feedthroughs, cables, and grounding, was successfully prototyped at large scale in MicroBooNE and ProtoDUNE-SP, and is 90% mature.
  - The FE chip has gone through eight iterations and was successfully demonstrated in MicroBooNE and ProtoDUNE-SP (90%).
  - The front-end mother board (FEMB) has gone through a similar number of iterations and was successfully demonstrated in ProtoDUNE-SP (80%). We have gained important knowledge from the FEMB development cycles, in particular about techniques of the power distribution and signal routing for the low-noise design. New FEMB prototypes for the SP module that use new custom ASICs differ from the ProtoDUNE-SP version only in the physical layout of the power distribution and the interconnections between two ASICs. From a logical point of view there are very few differences between

FEMBs accommodating different ASICs. This has been demonstrated by the recent FEMB design with ColdADCs showing nice performance from the lab test results.

- The analog-to-digital converter (ADC) chip has evolved from a previous version used in CMOS 180 nm technology that was tested to  $-50^{\circ}\text{C}$ . (70%).
- Key elements of the COLDATA chip have been prototyped (70%).
- The HV design has evolved from ICARUS, MicroBooNE, and the 35 ton prototype. It has been prototyped in subsequent runs of the 35 ton prototype and demonstrated in ProtoDUNE-SP (80%).
- The PD system X-ARAPUCA design has been prototyped at small scale and in ProtoDUNE-SP (20%). The mechanical design has been extensively developed using the 35 ton prototype detector and ProtoDUNE-SP (85%).
- The DAQ artdaq back end has been developed in several experiments, including the 35 ton prototype and ProtoDUNE-SP. The DAQ Front-End Link eXchange (FELIX) FE has been developed by ATLAS and prototyped in ProtoDUNE-SP.

The design maturity of the DP detector technology is also quite advanced. It builds on working noble liquid TPCs for dark matter and neutrinoless double beta decay experiments. A significant benchmark is the operation of the WA105 DP demonstrator at CERN. The successful construction of ProtoDUNE-DP and tests in the cold box at CERN provide invaluable experience. A critical test will be operation and analysis of ProtoDUNE-DP at CERN.

## Chapter 7

# Integration engineering

The DUNE FD consists of SP modules and DP modules, housed inside cryostats, which in turn are housed inside the LBNF FSCF. This nested structure is mirrored with detector integration in a similar layered manner. This chapter explains the method of integration for the detector modules. The integration of the modules is carried out by the technical coordination engineering support team working within the broader framework of the JPO central engineering team.

Integration engineering for DUNE focuses on configuring the mechanical and electrical systems of each detector module and managing the interfaces within them. This includes verifying that subassemblies and their interfaces are built conforming to the approved design, e.g., APA or PD system. The second major focus is assuring that the detector modules can be integrated and installed into their final configuration. And the third major focus is integrating necessary services provided by CF with the detector modules.

To this end, the JPO engineering team maintains subsystem component documentation in order to manage the detector configuration. The consortia provide engineering data for their detector subsystems to the JPO team for incorporation within the global configuration files.

This process, used successfully for ProtoDUNE, has been enhanced with the addition of engineering and design staff and development of interface documents as described in section A.1.

### 7.1 Mechanical integration models

The SP and DP detector modules are large and made of many intricate components. Fortunately, for the most part, the components are repetitive and not overly complex geometrically. Thus, 3D mechanical modeling techniques are well suited to represent the detector modules and manage their configuration.

At the same time, 3D modelling techniques vary in the way items are represented and in the way the techniques are carried out. Thus, a set of 2D integration drawings must be generated; these drawings must be clear and unambiguous across the collaboration. Such 2D drawings are the basis for the 3D model accuracy, as well as the basis for the engineering design of all components.

The consortia choose their mechanical modeling software. Their model files are transferred via STEP files,<sup>1</sup> which the JPO engineering team integrates into overall models. Navisworks<sup>2</sup> software allows for visualization by the entire collaboration.

<sup>1</sup><http://www.npd-solutions.com/step.html> “Standard for the Exchange of Product Model Data”, ISO Standard 10303.

<sup>2</sup>Navisworks™ <https://www.autodesk.com/products/navisworks/overview>.

### 7.1.1 Static models

Technical coordination engineering support team generates and maintains 3D detector integration models as well as 2D integration drawings of the detector. These models represent the detector at Normal Temperature and Pressure (101.3 kPa and 20°C). These models are static because they represent all components at their design dimensions and locations. They do not represent effects of gravity, tolerances, cold temperature, and installation and assembly clearances. Such effects are modeled in the envelope and assembly models, as described in section 7.1.2.

The 3D models are assembled by combining component models from various consortia then shared with the consortia. The 2D integration drawings, which are generated from the 3D models and disseminated, show the interfaces to the level of detail necessary to ensure proper fit and function. Any issues that arise are communicated to the consortia, and a resolution method is determined.

The JPO engineering team will not change any consortia component models. The consortia must resolve any issues using agreed-upon methods and provide updated models for reintegration. Using this process, models are kept synchronized with integration occurring in only one direction: only the consortia modify their models, and the JPO engineering team integrates and disseminates them. The technical coordination engineering support team works with the consortia as needed to keep their subsystem models current. The JPO engineering team defines points in the design process where current models are combined and identified as the official current integration model.

The level of detail in a model is managed actively. When models are combined and incorporated into global models of facilities, too much detail leads to very large file sizes. The JPO engineering team must ensure the appropriate level of detail at each stage of model integration.

Several examples from the SP module are presented here. Figure 7.1 shows the overall model of the SP module with one wall of the cryostat removed to make the interior components visible. The detector has 25 rows, all of which follow the same construction. At the ends of rows 1 and 25, endwall FCs are installed to close the detection volume. As mentioned earlier, this model does not include all the details of the detector components. The components are simplified to keep the overall model complexity to a manageable level.

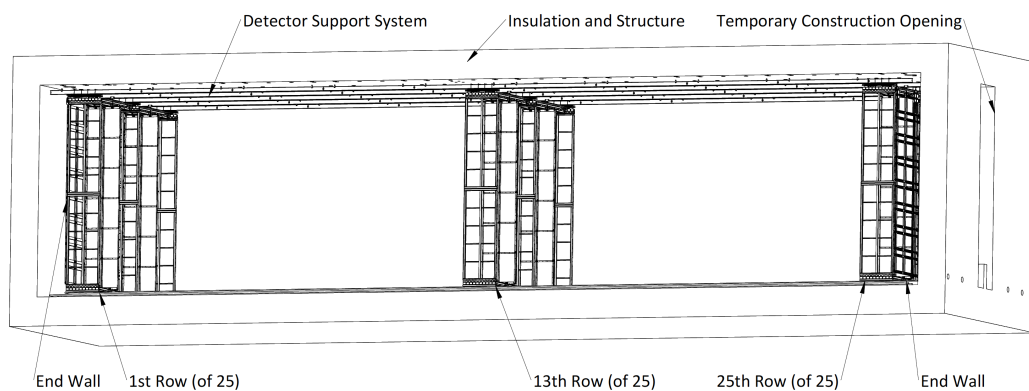

**Figure 7.1.** Overall model of the SP module showing three of the 25 rows, simplified cryostat, DSS and temporary cryostat opening.



Figure 7.2 shows the model of one row of the detector module. Each row is constructed from six APAs, four CPAs and eight FCs and GPs. A total of 25 rows comprise one SP module.

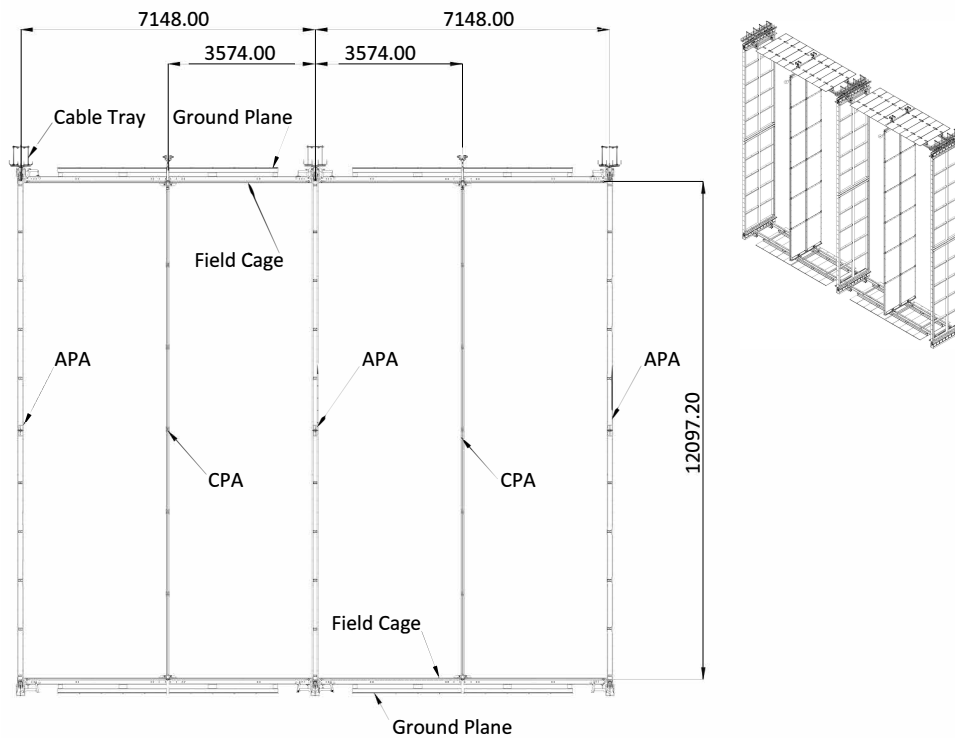

**Figure 7.2.** Model of one row of SP module showing overall arrangement and dimensions.

Figure 7.3 shows a cross section of the SP module in the transverse direction and the overall dimensions. Figure 7.4 shows a cross section of the SP module in the longitudinal direction and the overall dimensions. In both figures, the cryostat structure and insulation are shown as cross-hatched areas.

### 7.1.2 Envelope and assembly models

Static models represent the detector module and its components using their exact design dimensions. Such exact dimensions are needed so that the detailed component drawings and model remain completely compatible at all times.

For installation and operation, however, other envelope models are needed. Envelope models are developed to address issues that affect installation and operation:

1. effects on the detector caused by distortion of the cryostat and detector support structure due to gravity;
2. effects on the detector caused by distortion of the cryostat and detector support structure due to loads on the cryostat during detector filling and operation;
3. effects on the detector caused by thermal contraction during detector filling and operation;
4. effects of component and assembly tolerances;

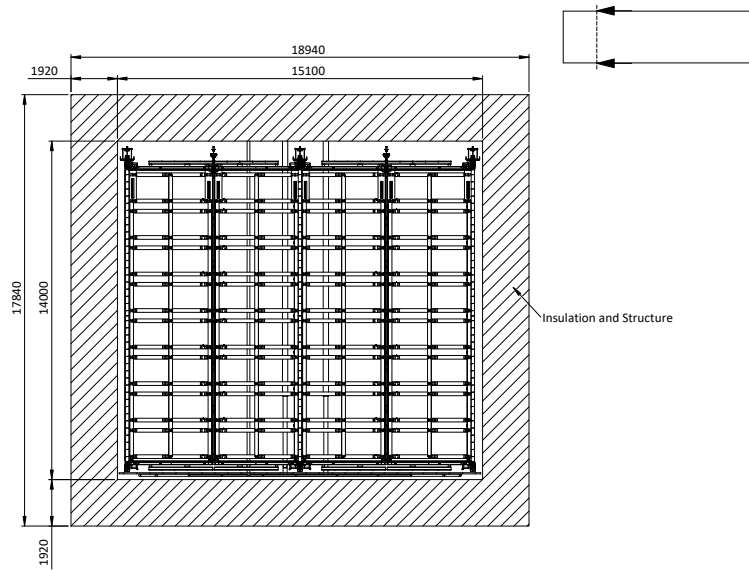

Figure 7.3. Section view of the SP module in the transverse direction.

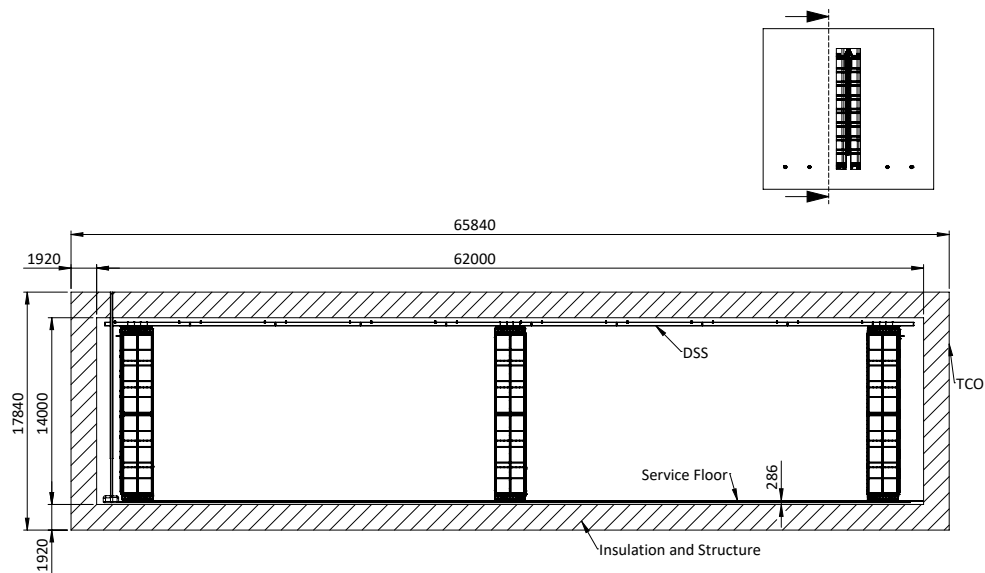

Figure 7.4. Overall model of the SP module in the longitudinal direction.

5. clearances needed for installation and envelopes needed for access and tooling;
6. reference models and drawings needed for installation stages and to control assembly; and
7. reference models and drawings needed for alignment and survey.

The models and drawings described above are generated from static models. Models are also generated to represent combined effects of the above. In all cases, as with static models, 2D drawings are created and provide the basis for the installation drawings.

Generating envelope models and drawings are the responsibility of the JPO engineering team in coordination with consortia.

### 7.1.3 Integration and interface drawings

Within each detector module, components from various consortia are assembled and installed. In addition, components that are the responsibility of integration office are assembled and installed in parallel. The interfaces among components are developed and managed through models and drawings as described in section 7.1. Many such interfaces must be controlled to ensure that the detector will fit together. The following section shows some of the interfaces, control drawing, dimensions, and configurations.

Figure 7.5 shows the interfaces for the top APAs in the upper corner of the cryostat. It also shows the position of the cable penetration for the APA. Interfaces with cryostat corrugations and LAr fill lines are also shown. The reference plane, defined as the plane of the APA yokes, is explained in the alignment section (section 7.1.4).

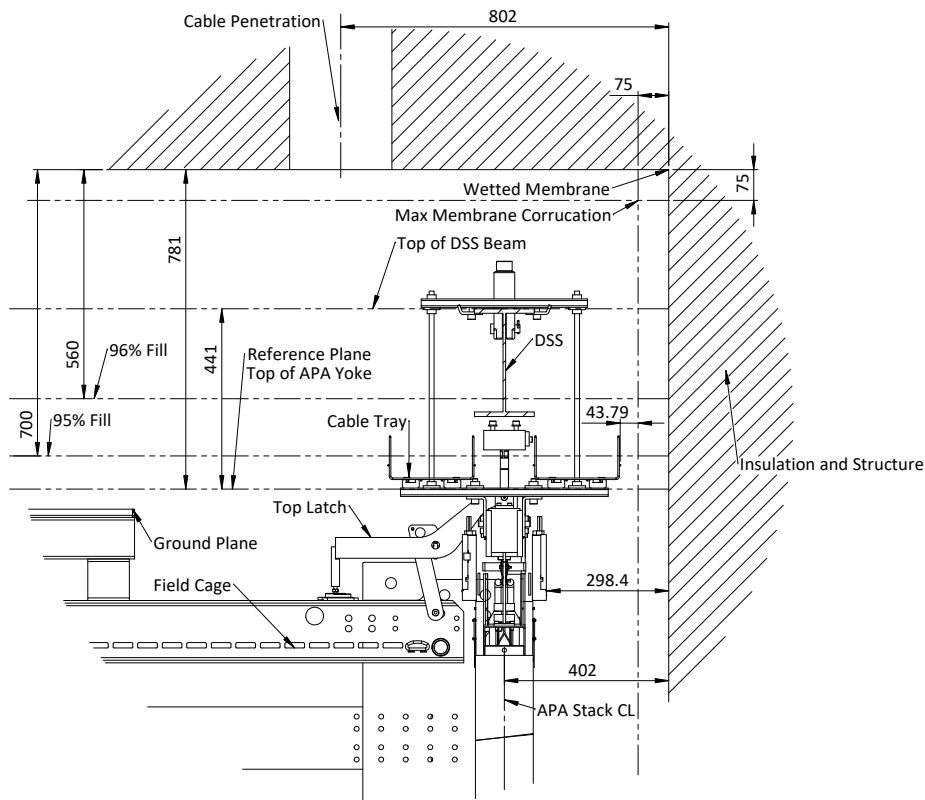

**Figure 7.5.** SP module interface between upper APA, FC, cable trays, and DSS.

Figure 7.6 shows the interfaces for the bottom APAs in the lower corner of the cryostat. In both figures, the connection latch between the FCs and APAs is also shown.

Figure 7.7 shows the interfaces for the top of the central row of APAs with other components. In this case, a double latch connection is used. Similarly, figure 7.8 shows the interfaces for top of the CPAs with other components.

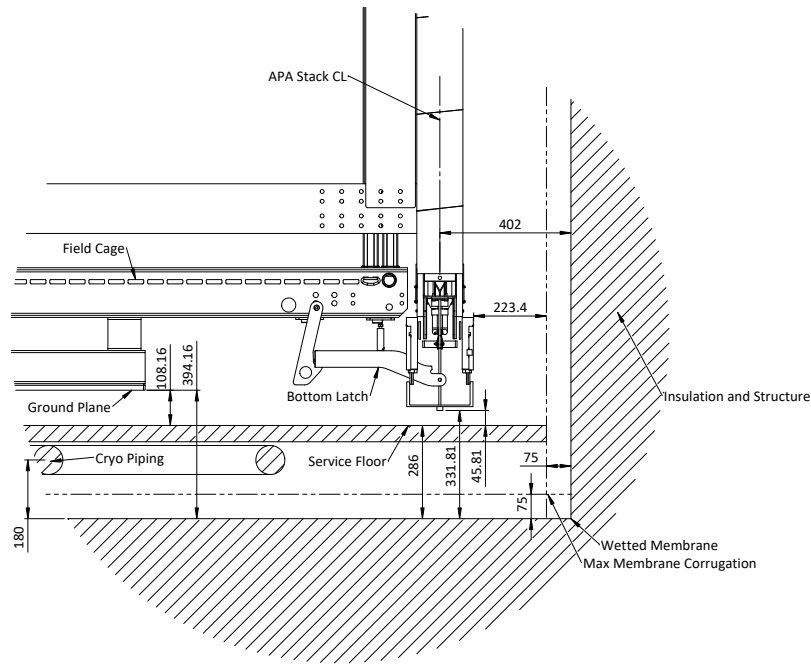

**Figure 7.6.** SP module interface between lower APA, FC, and service floor.

These integration drawings are derived directly from the overall integration model. The overall integration model is assembled from component models developed by the consortia. Interfaces are controlled by technical coordination, and consortia maintain their model files to be compatible with the interfaces. During the design phase, models are assembled and checked continuously. At the time of final design, all interfaces will be finalized.

Component tolerances and installation clearances are managed through additional models as described in section 7.1.2. Figure 7.9 shows the APAs and CPAs as well as their relative positions that show how they are constrained within the detector.

Figure 7.9 shows design dimensions. Component tolerances and assembly tolerances for the upper and lower APA and CPA stacks have been analyzed and are represented as envelope dimensions. An envelope gap has been defined to account for tolerances in the support system position and among components. Taking all of these into account, pitch distances for APAs and CPAs have been defined in the warm state.

This figure also shows the design drift distance in the warm state. The drift distance is defined as the perpendicular distance between the surface of CPAs and the collection wire plane of APAs.

APAs and CPAs are supported in groups of two or three on DSS beams. Fifty beams are arranged into five parallel rows with 10 beams in each row. In the cold state, the relative positions between groups of APAs that are supported on different beams change due to thermal contraction of the beams. Relative positions within each group supported on the same beam are relatively constant since APA frames and DSS are both made from stainless steel. The effect is that the gap in the active area between some APAs increases. As can be seen in figure 7.10, in the warm state, the gap in the active areas between adjacent APAs is 28 mm (dotted line). In the cold state, nine of the 24 gaps increase to approximately 45 mm.

2020 JINST 15 T08009

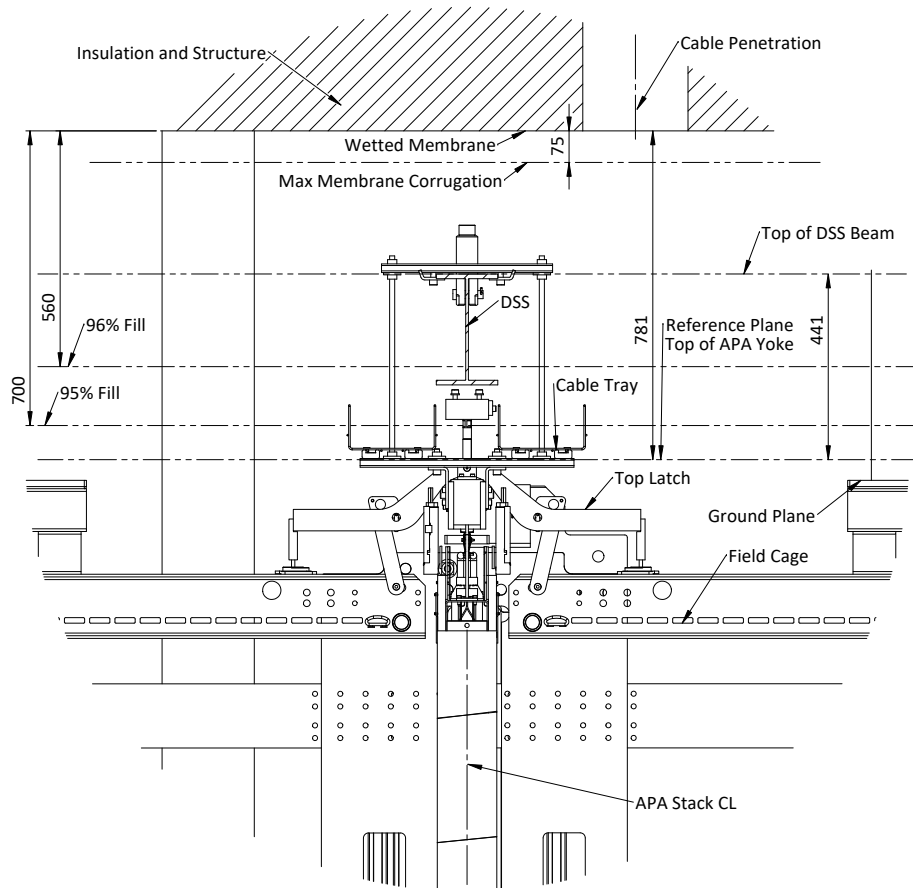

**Figure 7.7.** SP module interface between APA, upper FC, and GP.

The effects of gravity and buoyancy are not represented in the above analysis. Such effects are under study and will be shown in the models as design progresses.

Finally, figure 7.11 shows the interface of the cryostat service floor with other components. Before installing the detector module, a set of cryogenic distribution pipes are installed on the floor of the cryostat. These as well as the corrugations of the cryostat membrane would impede movement, hence the need for a temporary service floor. It will be installed, and later removed, in sections.

#### 7.1.4 Detector survey and alignment

The requirement for detector placement within the cryostat is driven by overall mechanical assembly needs rather than physics. Interfacing parts must be assembled properly and function as intended.

In this section, reference frames for the detector are defined so that the overall survey and alignment can be done within the cavern reference frame.

For the SP module, we define a flat and horizontal reference plane coplanar with the upper APA yoke plane; i.e., 75 yoke planes define this plane. This reference plane is set at exactly 781 mm below the theoretical plane of the cryostat top membrane.

2020 JINST 15 T08009

2020 JINST 15 T08009

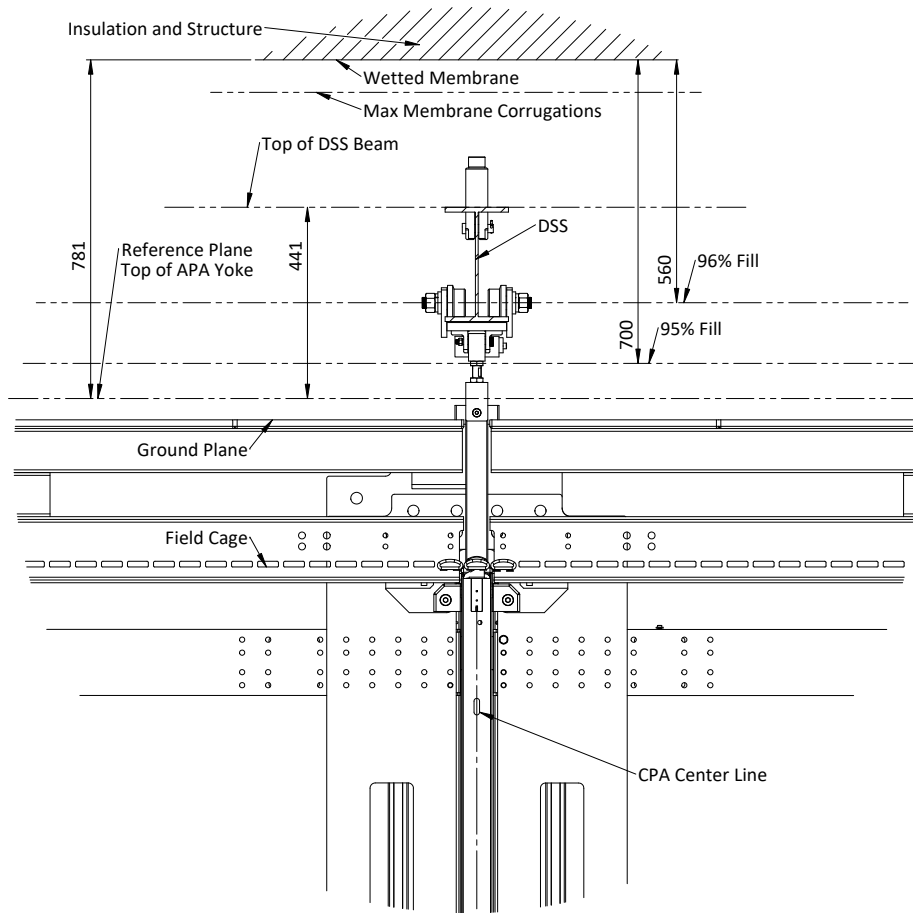

Figure 7.8. SP module interface between CPA, upper FC, and GP.

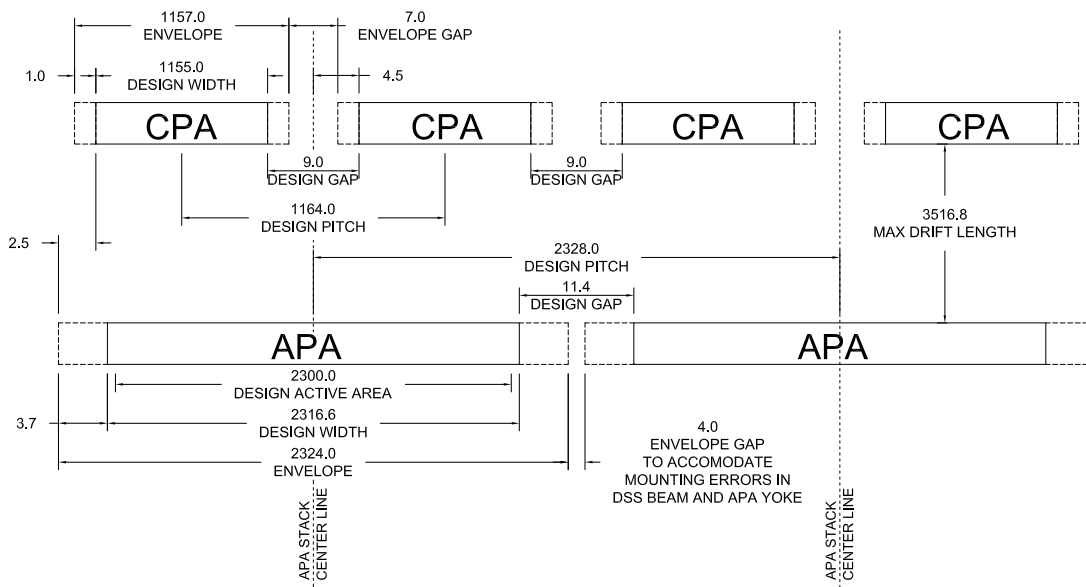
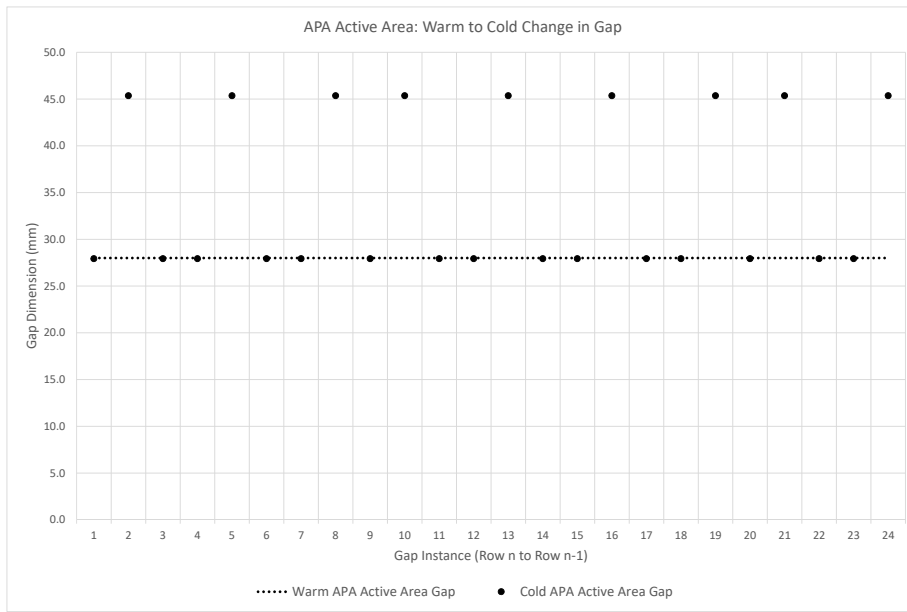
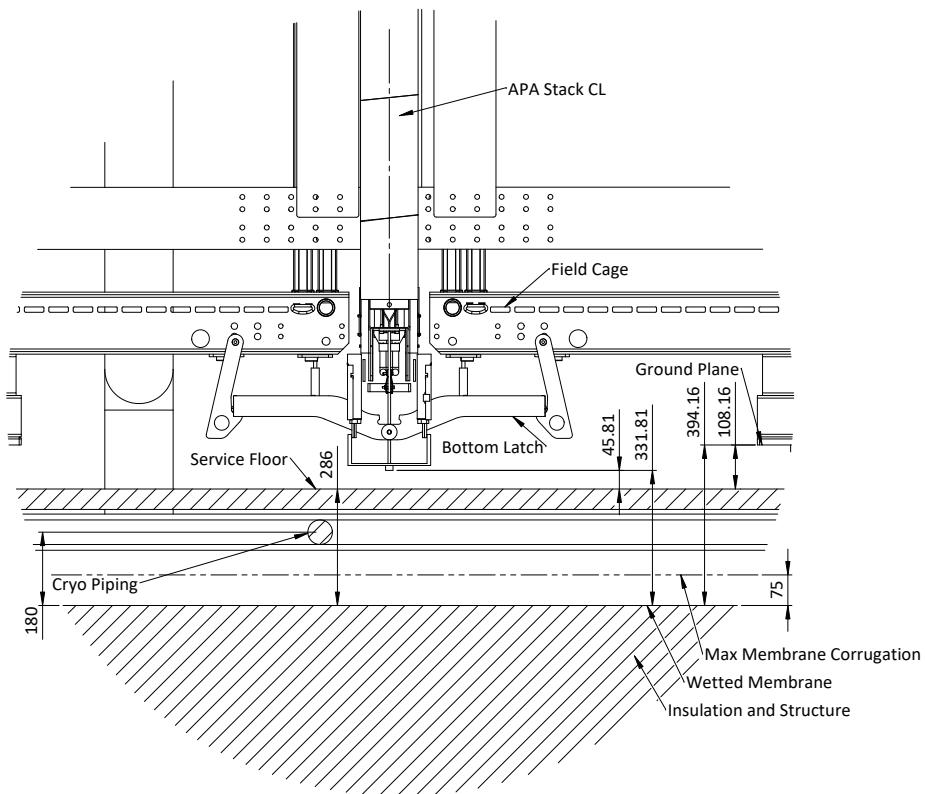

Figure 7.9. SP module graphical representation of envelope dimensions and installation clearances for APAs and CPAs in the warm state.



**Figure 7.10.** SP module gap in active areas between adjacent APAs in the cold state. Dashed line warm state, dots cold state.



**Figure 7.11.** SP module interface of cryogenic distribution pipes, service floor, and detector.

The detector reference plane is coplanar with the upper APA yoke planes because all features, including the active area, are referenced to this plane. Once this reference plane is defined and established through survey, all vertical distances within the detector are referenced and established relative to it. Figure 7.7 shows the reference plane in relation to the cryostat top membrane and DSS.

During installation, the height of the DSS beams is set in accordance with this relationship. Adjustments are made in the DSS to ensure that all the beams are in the correct plane. The combined effects of gravity, buoyancy, temperature, and LAr mass after fill are calculated, and further adjustments are made to compensate. This will ensure that the TPC position remains as close as possible to nominal after fill.

The transverse position of the detector is constrained to the center of the cryostat. Thus, the mid-plane of the middle row APA is coplanar with the vertical mid-plane of the cryostat. This relationship is verified when the DSS beams and central row of APAs are installed. The outer rows are similarly aligned and surveyed with the offset as shown in figure 7.2.

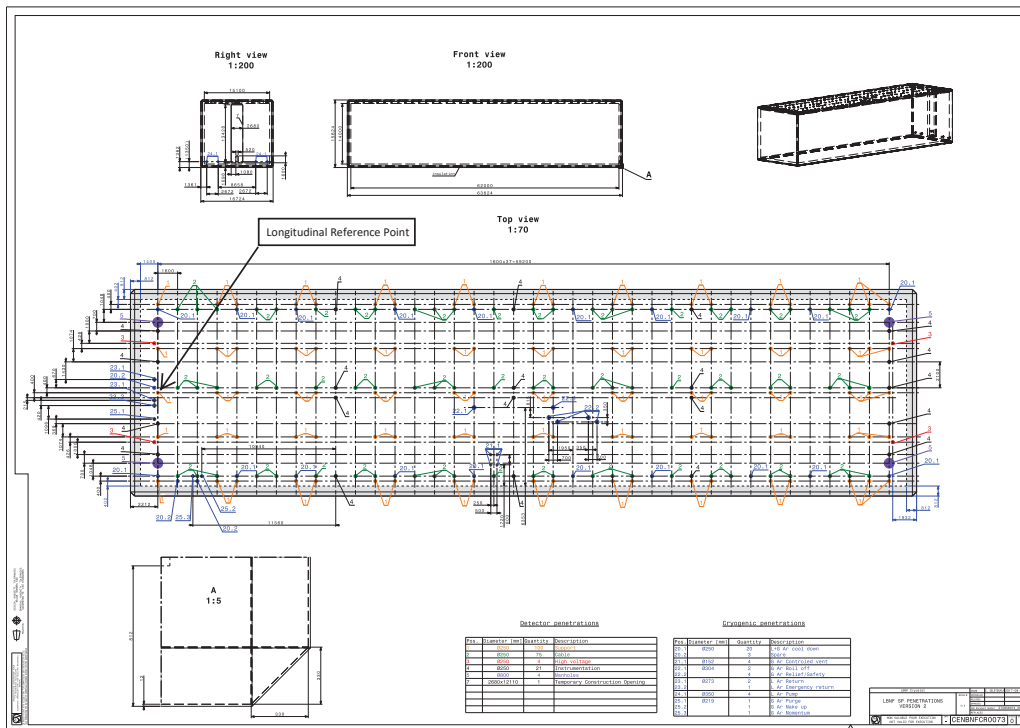

Figure 7.12. Position of feedthrough determining the longitudinal reference point of the SP module.

The longitudinal reference point of the detector within the cryostat is defined by the position of the single feedthrough of the central row farthest from the cryostat opening. This feedthrough position is shown in figure 7.12.



## 7.2 Electrical integration

### 7.2.1 Electrical system block drawings, schematics, layouts and wiring diagrams

The integration office is responsible for the AC power distribution supplied to the experiment and to detector electronics racks. This is described in sections 5.6 and 5.7. Specific guidance has been provided regarding the use of DC power supplies and cable shield treatment [4]. They are the same as were followed at ProtoDUNE and developed during extensive testing of the APA wire readout at Brookhaven National Laboratory (BNL) and ProtoDUNE. Guidelines are included for the treatment of DC power supplies and the use and connection of shielded cables. All systems are reviewed for compliance to these guidelines during the design review procedure. Any deviation from the guidelines must be noted and approved by system engineering.

The JPO engineering team will review all electrical systems to ensure that they follow safe design practice and will pass operational readiness reviews as discussed in chapter 8. Review by the JPO engineering team will include vetting of all power and ground paths, adherence to national electrical standards or equivalents for all commercial equipment, and adherence to the DUNE electrical design rules.

The electrical design of each subsystem is described by a set of documents that includes a system-level block diagram and a wiring diagram that includes a complete description of all power and ground connections. Depending on what is being described, a complete set of schematics, board production files, and wiring diagrams will be reviewed and archived. All designs are subject to electrical safety review, as described above, before production proceeds. The safety reviews proceed in conjunction with the overall review process as described in chapter 8.

Consortia will produce system-level block diagrams. The TC will ensure that these diagrams are produced and reviewed. In some cases, multiple diagrams may be required, e.g., the CISC consortium is responsible for several types of systems (such as temperature readouts, purity monitors, cameras, pressure sensors), each requiring a separate diagram. A system-level block diagram should show the conceptual blocks required in the design along with connections to other conceptual block elements, both inside and outside the given consortium. Figure 7.13 shows an example of a system-level block diagram.

All consortia must provide an electrical wiring diagram that represents the power and ground distribution within the system being described. The paths of power and ground distribution wiring between circuit elements are specified along with wire types and sizes. Power elements like power supplies, fuses (or other protective circuit elements), power connectors, and pin and wire ampacity are documented.

Electrical schematics show very specifically how individual components are connected. Usually, a schematic will represent a PCB design. Schematics call out specific parts that are used in the design and include all interconnections. In the case of a PCB, layout files, manufacturing specifications, and bills of materials document the design and allow a safety review of any custom boards or modules.

Wiring diagrams include all wire and cable connections that run between PCBs or electronics modules. Wires and cables are described within the diagram and include identification of American wire gauge (AWG), wire color, cable specification, and cable connectors and pinouts.

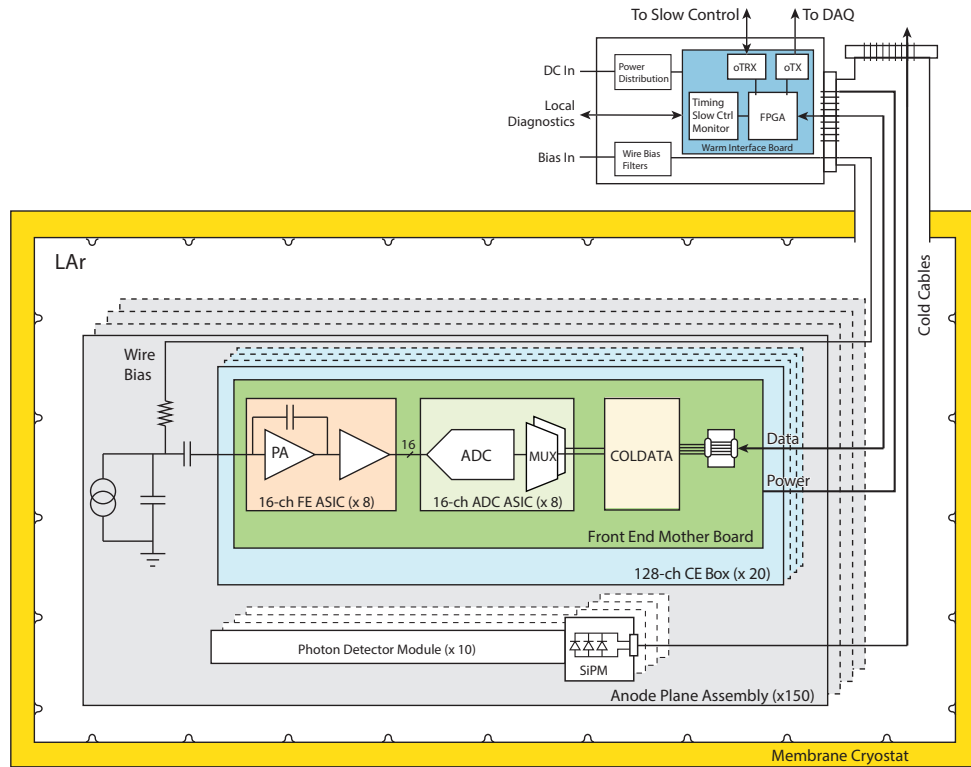

**Figure 7.13.** Electrical system-level block diagram example (SP module TPC electronics).

## 7.2.2 Electrical integration documentation

Interfaces that occur between subsystems of different consortia will be documented and formally agreed upon between the technical leads of the coordinating consortia and must be verified by the JPO engineering team. Much of the documentation required to describe a subsystem can be used for the interface documents.

Documentation required for the interface between two electrical subsystems includes a block diagram that identifies all connections between the subsystems. This block diagram must exist in the formal interface document between consortia. For each connection, additional documentation must fully describe the interface details. This additional detailed information can exist outside of the primary interface document between the consortia, but that document must point to it.

A signal cable that runs between PCBs belonging to different consortia is an example of an integration interface. For a signal cable, interface documentation includes the connector specifications, pinouts at each end of the cable, and the pinout of the board connectors. Documentation would also describe relevant electrical signal characteristics that may include signal levels, function, protocol, bandwidth and timing information. If different subsystems refer to a given signal by different names, documentation of signal name cross reference must be provided.

Consortium technical leads and the JPO engineering team sign off and approve the detailed documentation information on integration interfaces not included in the primary consortium-to-consortium interface document.

The JPO engineering team will provide unique names and labels for all racks, crates, boards, power supplies, cables, and any other electrical type equipment. A database will be created to track these devices.

### 7.3 Configuration and drawing storage and dissemination

The consortia and JPO engineering team create and share drawings, models, schematics, production data, and all other engineering documents. In addition, the JPO engineering team generates and shares all interface drawings and documentation.

Folders have been set up to allow uploading and sharing documents with appropriate protection. The structure of the folders has been set up to suit each consortium. The consortia do not necessarily have similar folder structures or files and will adapt the structure to fit their needs.

The folders and files reside on the EDMS. This system and similar structures were used for ProtoDUNE and are being used by LBNF.

The following shows a high-level outline of the file structure. The first section is for technical coordination files. The second section is generic, intended for a consortium. Each consortium will have one such folder.

1. technical coordination
  - (a) mechanical drawings and files (controlled by DUNE lead mechanical engineer)
    - i. FD general drawings for illustration (controlled by TC),
    - ii. 3D model files of internal detector for periodic upload to global model,
    - iii. 2D interface drawing files,
    - iv. alignment and survey files,
    - v. Ash River installation test facility files,
    - vi. QA/QC files,
    - vii. safety analysis and documentation, and
    - viii. design reviews;
  - (b) electrical and electronics (controlled by lead electrical engineer of DUNE)
    - i. infrastructure requirements for grounding,
    - ii. consortium interface drawings,
    - iii. detector electronics grounding guidelines,
    - iv. detector safety system,
    - v. QA/QC files,
    - vi. safety analysis and documentation, and
    - vii. design reviews;
2. consortium files (one per consortium, controlled by consortium technical leads)
  - (a) 3D model files,
  - (b) 2D part drawing files,

- (c) production files,
- (d) general grounding diagrams,
- (e) system level block diagrams,
- (f) system level wiring diagrams,
- (g) software and firmware plans,
- (h) custom components, such as ASICs (one folder per component),
- (i) PCB components (one folder per component),
- (j) cable components (one folder per component), and
- (k) power supply components (one folder per component).

An image of the EDMS file structure is shown in figure 7.14.

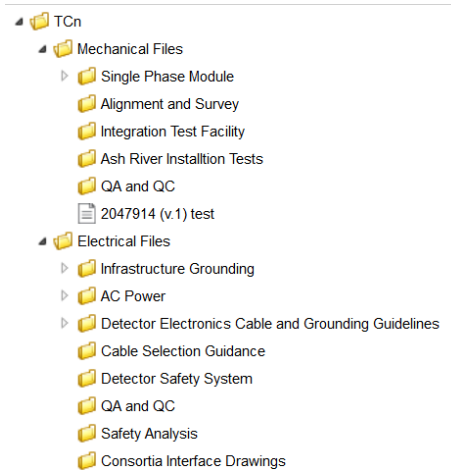

Figure 7.14. EDMS file structure.

## 7.4 Organization of interfaces and interface documents

An integration mechanism has been developed to manage and create an overall model of interfaces both within a detector module and between a detector module and facilities. The mechanism defines integration nodes, which can be thought of as focus areas, as explained below. The JPO engineering team carries out and manages interfaces between the nodes. The integration nodes comprise the following:

- **detector:** this consists of all TPC elements within the LAr. Almost all consortia are involved in this integration task, which is mostly mechanical. Consortium engineering teams work directly with the technical coordination engineering team. The primary interface is with DSS through hangers. Examples of interfaces within this node include FC connections to both CPAs and APAs, cold electronics (CE) and PD cable routing within the cryostat, and location of calibration, and cryogenics instrumentation.

- **DSS:** this consists of all detector support elements, cable trays, and feedthroughs.
- **detector electronics:** this consists of all racks, cooling, power, cable trays, cable distribution on top of the cryostats, rack protection (smoke detectors, hardware power trip), rack component build, and the interface to the DDSS.
- **DAQ and electronics:** this includes electronics on top of the cryostat, in the DAQ room and in the surface rooms. This also includes the fiber optic distribution from the surface to the DAQ room, and the fiber optic distribution from the detector modules to the DAQ room. It also includes the layout and cooling of the DAQ room.

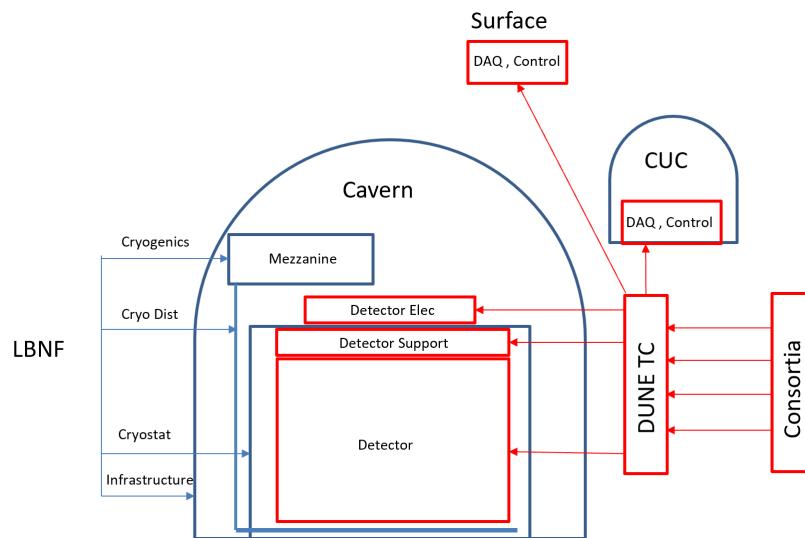

Figure 7.15. Overall integration nodes and interfaces.

Figure 7.15 shows the interfaces between the detector and facilities. In this figure, within the cavern, items provided by LBNF are on the left and the items provided by DUNE are on the right. In addition, the JPO engineering team integrates (ensures that the interfaces are appropriately defined and managed) the DAQ room in the CUC and surface control and network rooms. Interfaces with LBNF are managed at the boundaries of each integration node. As an example, the interfaces between LBNF and DUNE for the underground DAQ and control rooms are power, cooling water, data fibers, and cable penetrations at the room boundaries. DUNE is responsible for implementing power, cooling water, data, and signal cables, as well as integrating the racks.

Interface documents are developed and maintained to manage the interfaces between consortia and between each consortium and the TC. A single document covers the interface between any two systems, so any one system may have several interface documents. If no interface exists, the interface document is not provided. The interface documents are managed by the appropriate consortium technical leads and by technical coordination project engineers.

The content of interface documents varies depending on the type of interface. However, the documents are intended to have a common structure:

1. Definition: defines the interfacing systems.

2. Hardware: defines the interfacing hardware components, electrical and mechanical, in general terms. As an example, the APA frame needs to support the PD mounting brackets.
3. Design: describes the dependencies in design methodology, sequence, and standards. As with the previous example, the design of the PD mounting brackets depends on the side tubes chosen for the APA.
4. Production: details responsibilities for component production and overall assembly, which may be shared among interfacing systems.
5. Testing: details responsibilities for testing the required equipment. Like production, testing is a shared responsibility.
6. Integration: defines the integration of systems into installable units before insertion into the cryostat. It also defines the location, methodology, tooling, and environment for integration.
7. Installation: defines installation tasks and responsibilities, once installable units are assembled, and defines special transportation or installation tools or fixtures.
8. Commissioning: defines overall responsibilities for commissioning tasks and sets parameters.
9. Data format, control and error codes: communications protocols, responses and necessary actions are defined.
10. Appendices: includes technical figures and interfaces in as much detail as necessary. These must include block diagrams that show interconnections and detailed documentation of each connection.

The interface documents will be developed and modified during the technical design period. At the time of this writing, not all documents have been fully developed. Once the technical design is finished, the interface documents will be placed under revision control. A summary of the interface documents is provided in section A.1.

### **7.5 Engineering change control**

Changes in design and fabrication requirements follow revision processes for design and fabrication documents, per individual consortium practice, while ensuring appropriate levels of verification, review, and approval by the consortium design authority.

Either a consortium or technical coordination may initiate and request changes in design and fabrication requirements that involve interfaces among detector subsystems and between detector subsystems and the facilities. The JPO engineering team directs requests for changes through the technical board (TB). Any change that affects cost or schedule must be approved by the EB.

When shop or site work must be performed before a given design document under configuration management can be formally revised and re-issued, an engineering change request (ECR) must be developed, approved, and distributed. Inter-discipline reviews will be performed when the ECR subject matter may impact other subsystems. The design authority will indicate if it is a one-time change or if the change is to be incorporated into the design documents.

## 7.6 Value engineering

Value engineering is the process of arriving at cost-effective solutions to the technical challenges of building the DUNE detector. DUNE value engineering builds on significant developments in LAr detectors dating to the early 1970s, especially the large LArTPCs: ICARUS and MicroBooNE. Prototyping by both LBNE and LBNO has significantly advanced the value engineering process, leading to construction of the ProtoDUNE detectors. These detectors validate DUNE designs and confirm that the necessary performance is met. Any significant departure from current designs must account for the success of ProtoDUNE and may require testing in a second run of ProtoDUNE to validate that the change does not degrade performance.

The value engineering process is executed at both the consortium and technical coordination level. For example, the APA size has been optimized over the last 10–15 years, using input from dimensions of the Ross Shaft, shipping container size, and availability of high-quality long stainless steel tubes from reliable vendors. At this point, any significant change to the APA design would likely lead to new and significant re-engineering costs.

Value engineering is ongoing at all stages of design and will continue through the fabrication, assembly, and installation phases. In particular, during the fabrication and assembly stages, when labor costs are relatively higher, this process can result in significant cost savings. The consortia and technical coordination are actively engaged and have the necessary experience for this ongoing process.

## Chapter 8

### Reviews

The integration office and technical coordination review all stages of detector development and work with each consortium to arrange reviews of the design (conceptual design review, preliminary design review and final design review), production (production readiness review and production progress review), installation (installation readiness review), and operation (operational readiness review) of their system. The reviews are organized by the JPO review office. In parallel, the review office reviews all stages of LBNF cryostat and cryogenics development. These reviews provide information to the TB, EB, and EFIG in evaluating technical decisions. A timeline for the review process is shown in figure 8.1.

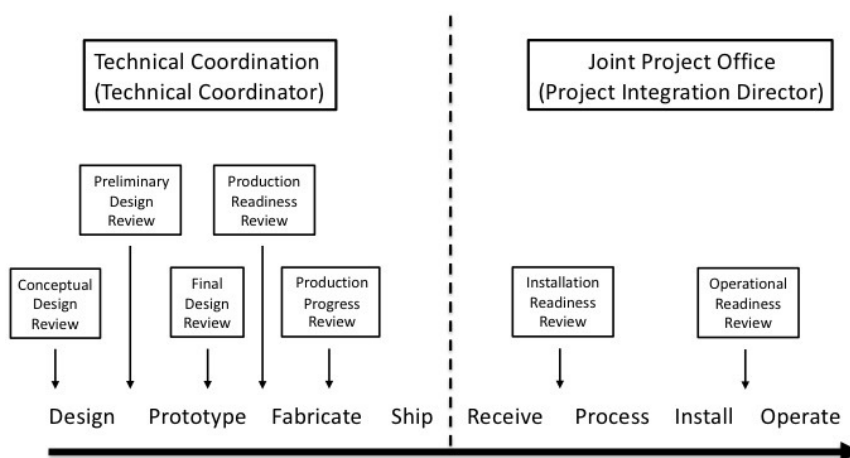

**Figure 8.1.** DUNE review process and timeline.

Review reports are tracked by the JPO review office and technical coordination and provide guidance on key issues that require engineering oversight by the JPO engineering team. The review office maintains a calendar of DUNE reviews. The calendar of reviews is developed by the review office in consultation with the project integration director, TC, LBNF project manager, consortia leads, and LBNF subsystem managers.

Technical coordination works with consortia leaders to prepare for reviews of all detector designs. As part of the TDR development preliminary design reviews were arranged for many



subsystems in advance of the TDR. Some remaining subsystem preliminary design reviews will occur after the TDR. All subsystems will undergo final design reviews. All major technology decisions will be reviewed before down-select. Technical coordination may form task forces as needed to address specific issues that require more in depth review.

Technical coordination works with consortia leaders to prepare for review of detector component production processes. Production of detector elements begins only after successful production readiness reviews. Regular production progress reviews will be held once production starts depending on the length of the production process. The production readiness reviews will typically include a review of the production of *Module 0*, the first module produced at the facility. Technical coordination will work with consortia leaders on all production reviews.

The integration office works with consortium leaders to prepare for reviews of detector installation processes and later of the installed detector components to ensure that they are ready for operations. Technical coordination coordinates technical documents for the Long-Baseline Neutrino Committee (LBNC) TDR review.

The review process is an important part of the DUNE QA process, as described in section 9.7.2, for design and production.

The review process has been in place since 2016 with various reviews of ProtoDUNE components and has continued into the first DUNE reviews in 2018–19. Past and scheduled reviews are in the DUNE Indico at <https://indico.fnal.gov/category/586>. Review reports are currently maintained in DocDB 1584 [6].

### 8.1 Design reviews

The DUNE design review process is described in DocDB 9564 [7]. An updated mandate for the review office is under development at [8]. Design reviews for ProtoDUNE were held for each major system. Because the schedule was extremely tight for ProtoDUNE, only a single design review was held for each major system. Similarly, a single production readiness review was held for each major system.

The successful operation of ProtoDUNE means DUNE is at a very advanced state of design. The strategy going forward has been to hold conceptual design reviews for systems with significant changes from ProtoDUNE, including the DSS, PD system, DAQ, and calibration. These are systems that require changes due either to the size difference between ProtoDUNE and DUNE or the fact that the former is in a test beam and the latter is underground. All systems will go through preliminary design reviews to review design changes from ProtoDUNE and final design reviews after the TDR.

Technical coordination has established an engineering safety committee with mechanical and electrical engineering experts from collaborating institutions to develop processes and procedures to evaluate engineering designs using accepted international safety standards. The current status of international code equivalencies is discussed further in section 10.3. The codes and standards to which each system is designed will be reviewed as part of the preliminary design review and final design review.

## 8.2 Production reviews

Once the designs are finished, production reviews will be held before significant funds are authorized for large production runs. These reviews are closely coordinated with the QA team. The expectation is that a *Module 0* be produced and presented as part of the production readiness review. The *Module 0* is the first article from the production line and provides a useful indication of the validity of production processes, time estimates, and quality of the product.

Once production has started, the review office will schedule production progress reviews as appropriate to monitor production schedule and quality. These reviews will consist of site visits and will include membership from the ES&H and QA teams.

The production readiness review process was exercised during ProtoDUNE-SP construction. Because the schedule was extremely tight for ProtoDUNE, only a single production readiness review was held for each major system, and no production progress reviews were held.

## 8.3 Installation reviews

Installation readiness reviews are planned to verify that equipment and procedures are in place prior to installation of detector components. These will review QC results to verify that as-built detector components can be successfully installed and operated. A critical part of these reviews is to establish and verify the HA for the installation activities and mitigate any identified safety risks. These reviews will include safety personnel from SURF and Fermilab as appropriate.

## 8.4 Operations reviews

The review office will conduct an operational readiness review on subsystems before they are operated. Operational readiness reviews serve as the final safety check after the equipment is installed. These reviews will include safety personnel from SURF and Fermilab, as appropriate.

## 8.5 Review tracking

Tracking and controlling review recommendations is part of the review process. Review committees assess recommendations from earlier reviews. The review office assures that consortia respond to review recommendations and works with the consortia to make sure the responses are appropriately documented and implemented. Reports from DUNE reviews are maintained in DocDB 1584 [6] along with the list of recommendations. The review office reports to the project integration director, TC, and LBNF project manager on recommendations and progress towards completing actions on these recommendations.

## 8.6 Lessons learned

A detailed list of lessons learned from construction and operation of ProtoDUNE-SP is in DocDB 8255 [9]. These lessons have driven planning for DUNE and have led to design changes in DUNE. Lessons learned will continue to be updated throughout the design review process and into production. The methodologies are described in section 9.4.

## 8.7 Reporting

The DUNE project has published regular monthly reports since the final design and construction of ProtoDUNE began in earnest in summer 2016. Technical coordination currently plans to continue to compile and publish these reports. The DUNE project provides regular reports to the LBNC at reviews several times a year. The JPO review office produces reports from design, production, installation, and operations reviews.

## Chapter 9

# Quality assurance

### 9.1 Overview of DUNE quality assurance

DUNE technical coordination monitors technical contributions from collaborating institutions and provides centralized project coordination functions. One part of this project coordination is standardizing quality assurance (QA)/quality control (QC) practices, one facet of which is to assist consortia in defining and implementing QA/QC plans that maintain uniform, high standards across the entire detector construction effort. Figure 9.1 shows how DUNE technical coordination derives its QA program from the principles of the Fermilab QA program: requirements are flowed down through the LBNF/DUNE QA program into the QC plans developed for consortium fabrication of detector components and integration and installation of the detector.

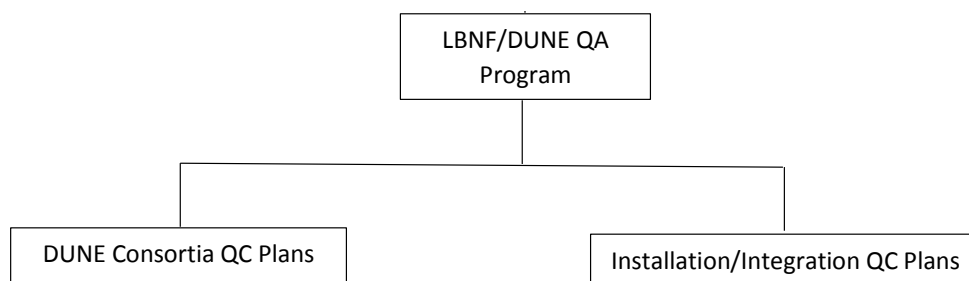

**Figure 9.1.** Flow-down of Fermilab QA to consortia.

The QA effort includes design, production readiness, and progress reviews as appropriate for the DUNE detector subsystems, as was done for ProtoDUNE-SP under technical coordination oversight. Installation and operations reviews fall under integration office oversight as is discussed in chapter 8.

#### 9.1.1 Purpose

The primary objective of the LBNF/DUNE QA program is to assure quality in the construction of the LBNF facility and DUNE experiment while providing protection of LBNF/DUNE personnel, the public and the environment. The QA plan aligns LBNF/DUNE QA activities, which are spread around the world, with the principles of the Fermilab Quality Assurance Manual. The manual

identifies the Fermilab Integrated Quality Assurance Program features that serve as the basis for the LBNF/DUNE QA plan.

The LBNF/DUNE QA plan outlines the QA requirements for all LBNF/DUNE collaborators and subcontractors and describes how the requirements will be met. QA criteria can be satisfied using a graded approach. This QA plan is implemented by the development of quality plans, procedures, and guides by the consortia to accommodate those specific quality requirements.

### 9.1.2 Scope

The LBNF/DUNE QA plan provides QA requirements applicable to all consortia, encompassing all activities performed from research and development (R&D) through fabrication and component commissioning, building on the success of ProtoDUNE. Consortia are responsible for providing their deliverables, whether subsystems, components, or services in accordance with applicable agreements. All parties are responsible for implementing a quality plan that meet the requirements of the LBNF/DUNE QA plan. Oversight of the work of the consortia will be the responsibility of the DUNE TC and LBNF/DUNE QA manager.

### 9.1.3 Graded approach

A key element of the LBNF/DUNE QA plan is the concept of graded approach; that is, applying a level of analysis, controls, and documentation commensurate with the potential for an environmental, safety, health, or quality impact. The graded approach seeks to tailor the kinds and extent of quality controls applied in the process of fulfilling requirements. Application of the graded approach entails

- identifying activities that present significant ES&H and/or quality risk,
- defining the activity,
- evaluating risk and control choice, and
- documenting and approving the application of the graded approach.

## 9.2 Quality assurance program

The LBNF/DUNE Systems Engineering teams maintain a LBNF/DUNE CMP [1], which identifies the LBNF project Configuration Items Data List (CIDL) and Interface Control matrices that provide the tier structure for the flow down of QA plans, with the LBNF/DUNE QA plan as the top tier.

With the assistance of the LBNF/DUNE QA manager, the consortia will develop specific QA plans for component or system QA. Due to the limited scope of work of some consortia, they may elect to work under the LBNF/DUNE QA plan for their scope of work. In case of conflict between sets of QA requirements, DUNE technical coordination will provide resolution.

With many institutions carrying responsibility for various aspects of the project, institutional QA plans will be reviewed by DUNE technical coordination to ensure compliance with the LBNF/DUNE QA plan. Using a graded approach, supplements to institutions existing plans will be implemented for their DUNE scope of work, if necessary.

Overall QA supervision, including all activities described above, is the responsibility of the DUNE TC.

### 9.2.1 Responsibility for project management

The DUNE consortium leaders manage their projects and are responsible for achieving performance goals. The LBNF/DUNE QA manager is responsible for ensuring that a quality system is established, implemented, and maintained in accordance with requirements. The LBNF/DUNE QA manager reports to the DUNE TC and provides oversight and support to consortium leaders to ensure a consistent quality program.

DUNE consortium leaders are responsible for quality within their project and report QA issues to the DUNE TC and LBNF/DUNE QA manager. DUNE consortium leaders designate QA representatives within their organization and delegate, as appropriate, work defined in the LBNF/DUNE QA plan, as shown in figure 9.2.

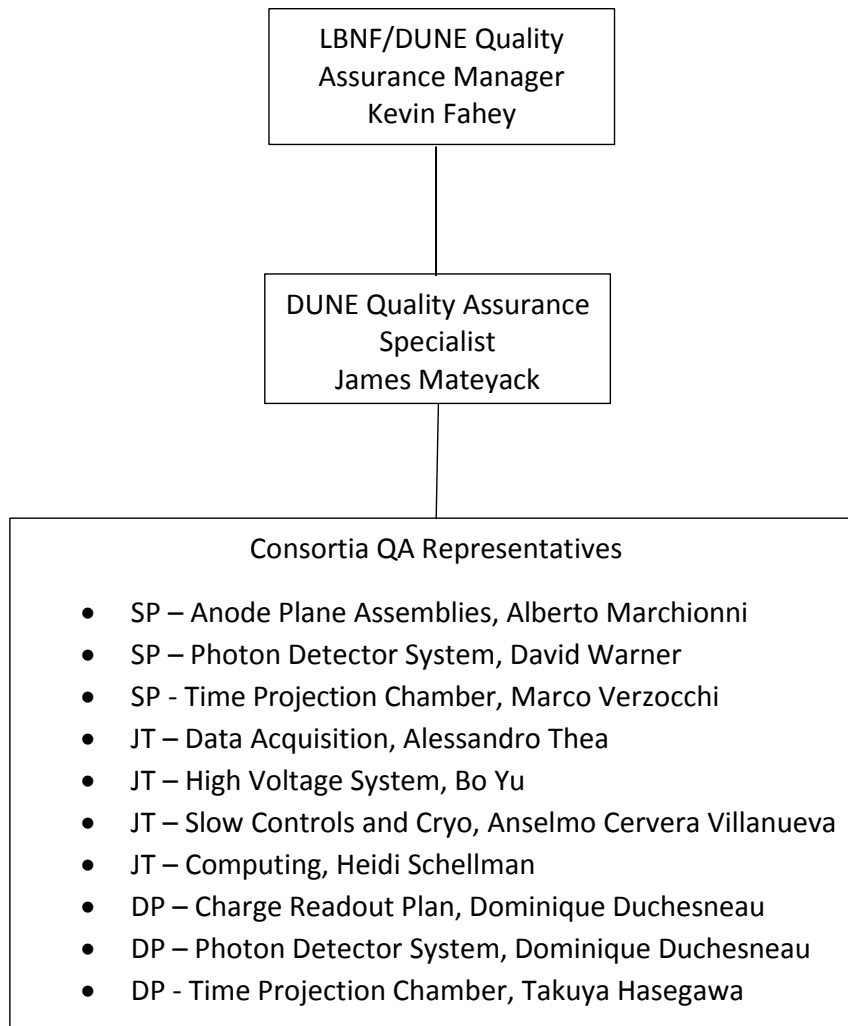

**Figure 9.2.** DUNE QA organization.

The DUNE consortium leaders retain overall responsibility for QA even though they have designated a QA representative.

### 9.2.2 Levels of authority and interface

The DUNE Management Plan, the LBNF/DUNE PMP and the LBNF/DUNE QA plan define the responsibility, authority and interrelation of personnel who manage, perform, and verify work that affects quality. The QA plan defines the QA roles and responsibilities of the DUNE project.

All consortium members are responsible for the quality of the work that they do and for using guidance and assistance that is available. Each has the authority to stop work and report adverse conditions that affect quality of DUNE products to their respective DUNE consortium leader and the LBNF/DUNE QA manager. The consortium leader responsible for DUNE components or systems is required to determine and document their acceptance criteria. DUNE personnel at each level are responsible for evaluation of quality through self-assessments; however, independent quality assessments may also be requested by project management. The LBNF/DUNE QA manager is responsible for development, implementation, assessment, and improvement of the QA program.

The LBNF/DUNE QA manager is responsible for periodically reporting on the performance of the quality system to the DUNE TC for review and as a basis for improving the quality system. The DUNE TC may call for QA plan readiness assessments as the project nears major milestones. The DUNE TC, consortium leaders, and LBNF/DUNE QA manager are all responsible for providing the resources needed to conduct the project successfully, including those required to manage, perform, and verify work that affects quality.

### 9.2.3 Quality assurance organization

LBNF/DUNE QA manager may request personnel from the DUNE project to act on behalf of the LBNF/DUNE QA manager to perform quality assurance functions, based on need, in accordance with the graded approach described above. The requested personnel must possess qualifications or receive the appropriate training required to perform these functions.

The DUNE QA Specialist will be responsible for the following activities:

- Cooperatively develop, monitor, and control DUNE QA procedures to assure compliance with DUNE standards and applicable laws;
- Provide assistance for QA/QC matters in project plans, including strategizing technical solutions and alternatives on QA/QC matters and assist in developing testing plans with project team members;
- Participate in audits, site inspections, accident investigations, and monitor trend analysis to identify areas of concern and implement improvements;
- Interact with all stakeholders on QA issues;
- Provide guidance and interpretation on routine and complex QA matters and problems; and
- Participate in reviews at collaborating institutions.

Each consortium selects a QA representative. Each consortium QA representative is responsible for overall coordination of quality requirements to assure they meet consortium objectives. The QA representative is expected to

- oversee the consortium fabrication facilities for quality performance;
- interface with the DUNE QA specialist on consortia QA related matters;
- monitor the status of all required testing based on the consortium QC plan;
- make sufficient fabrication facility visits to determine adequacy of QC system performance: check certifications of materials and equipment delivered to the facility, spot check workmanship, observe testing procedures; and
- make or arrange production progress reviews during the fabrication cycle in coordination with technical coordination and the JPO review office.

Figure 9.2 shows the interface between the LBNF/DUNE QA organization and the consortium QA representatives. These interfaces will remain when the equipment is shipped to the far site for installation, but the names may change for the consortium QA representatives. The consortium QA representatives remain responsible for QA/QC during the detector installation process.

### 9.3 Personnel training and qualification

The DUNE consortium leaders are responsible for identifying the resources to ensure that their team members are adequately trained and qualified to perform their assigned work. Before allowing personnel to work independently, they must ensure that their team members have the necessary experience, knowledge, skills and abilities. Personnel qualifications are based on the following factors:

- previous experience, education, and training;
- performance demonstrations or tests to verify previously acquired skills;
- completion of training or qualification programs; and
- on-the-job training.

All DUNE consortium leaders are responsible for ensuring that their training and qualification requirements are fulfilled, including periodic re-training to maintain proficiency and qualifications.

### 9.4 Quality improvement and lessons learned

Lessons learned have been developed and utilized by the consortia in the development of the latest designs. A lessons learned program guideline and worksheet has been developed for the use by the consortia DocDB 8921 [10]. The project is now at a stage where it is utilizing the lessons learned gathered from ProtoDUNE. The lessons learned program remains active although the project is in the design phase. Lessons learned are being collected during the performance of activities associated with ICEBERG R&D cryostat and electronics (ICEBERG), Ash River APA Installation Test Assembly, CERN cold box facility, and developments toward ProtoDUNE-2.



All DUNE consortium members participate in quality improvement activities that identify opportunities for improvement. They can respond to the discovery of quality-related issues and follow up on any required actions. This quality-improvement process requires that any failures and non-conformance be identified and reported to the appropriate consortium leader, and that root causes be identified and corrected. All consortium members are encouraged to identify problems or potential quality improvements and may do so without fear of reprisal or recrimination. Items, services, and processes that do not conform to specified requirements must be identified and controlled to prevent their unintended use. Inspection and test reports or similar tools will be used to implement this requirement. Each consortium leader is responsible for reporting non-conformance to the LBNF/DUNE QA manager, who will periodically report these non-conformance to DUNE technical coordination.

DUNE consortium members will perform root cause analysis and corrective and preventive actions for conditions that do not meet defined requirements. Consortium leaders may perform root cause analysis and corrective and preventive actions under their own procedures or Fermilab procedures. This problem identification, analysis and resolution process for quality consists of the following steps:

1. identify problem;
2. understand the process;
3. grade the process and identify Root Cause Analysis (RCA) method;
4. identify possible causes;
5. collect and analyze data;
6. communicate lessons learned and document RCA; and
7. implement corrective and preventative action procedure.

To promote continuous improvement, DUNE technical coordination will develop a lesson learned program based on the Fermilab Office of Project Support Services Lessons Learned Program. This program provides a systematic approach to identify and analyze relevant information for both good and adverse work practices that can influence project execution. Where appropriate, improvement actions are taken to either promote the repeated application of a positive lesson learned or prevent recurrence of a negative lesson learned. Lessons learned will be gathered throughout the project life cycle. As part of the transition to operations a lessons learned report will be submitted.

In addition, the LBNF/DUNE QA manager will periodically publish a best practices and lessons learned report. Lessons learned from the DUNE project will be screened for applicability to other organizations. The DUNE project will periodically check external lessons learned sources for applicability to the DUNE project. Sources of lessons learned include the DOE Lessons Learned List Server, the Fermilab ES&H Lessons Learned Database, and DUNE team members who participate in peer reviews of other projects. Reviews of the DUNE project serve as input to quality improvement.

## 9.5 Documents and records

Engineering and technical documents (including drawings) are prepared by DUNE personnel to define the design, manufacture, construction, and installation of their equipment. Ultimately, before these documents are put into effect they are reviewed and signed by the DUNE consortium leader or designee. The DUNE project manages all documents under the document control systems: EDMS and DUNE DocDB, as identified in the DUNE CMP [1]. The system to control document preparation, approval, issuance to users and revision is also described there. Consortium leaders will use the graded approach described in this plan to determine work in their scope that requires LBNF/DUNE QA manager review and signature. This person also reviews project documents that contain quality requirements.

Records are prepared and maintained to document how decisions are made, for instance, decisions on how to arrive at a design, how to record the processes followed to manufacture components and the means and methods of cost and schedule change control. LBNF/DUNE will follow the guidelines for storing and maintaining records for the project in accordance with Fermilab Records Management.<sup>1</sup> The DUNE TC, LBNF/DUNE QA manager and consortium leaders are responsible for identifying the information to be preserved. In addition to the technical, cost, and schedule baseline and all changes to it, records must be preserved as evidence that a decision or an action was taken, and to provide the justification for the decision or action.

## 9.6 Work processes

DUNE team members are responsible for the quality of their work, and consortium leaders are responsible for procuring the resources and support systems to enable their staff to complete their work with high quality. All DUNE work will be performed using methods that promote successful completion of tasks, conformance to DUNE requirements, and compliance with the LBNF/DUNE IESHP. Work processes consist of a series of actions planned and carried out by qualified personnel using approved procedures, instructions, and equipment, and under administrative, technical, and environmental controls, to achieve a high-quality result.

### 9.6.1 Fabrication work processes

Fabrication work on the DUNE project will be performed to established technical standards and administrative controls using approved instructions and procedures. Fabrication work processes with QA inspections and tests will be documented on travelers that are retained with the hardware item or electronically. Items, including consumables, will be identified and controlled to ensure their proper use and to prevent the use of incorrect, unaccepted, or unidentified items. Each consortium will define a system of controls to ensure that its items are handled, stored, shipped, cleaned, and preserved to prevent them from deteriorating, being damaged, or becoming lost. Equipment used for process monitoring or data collection will be calibrated and maintained.

Work must be performed safely, in a manner that ensures adequate protection for employees, the public, and the environment. Consortium members and the DUNE TC must exercise a degree

---

<sup>1</sup><http://ccd.fnal.gov/records>.

of care commensurate with the work and the associated hazards. See the LBNF/DUNE IESHP [11] for more details on LBNF/DUNE integrated safety management systems.

### 9.6.2 Change-controlled work processes

Changes to design and fabrication requirements should follow the normal revision process for design and fabrication documents ensuring the appropriate level of verification, review and approval by the relevant consortium and technical coordination. The change control process flow for DUNE, as currently envisioned, can be found in [1]. See figure 9.3. A Change Control Board (CCB) led by the TC advises the TC on changes.

When shop or site work must be performed before the associated design document can be formally revised and re-issued, such changes are accomplished through the development, approval, and distribution of an ECR. This applies to designs that are under configuration management. Interdisciplinary reviews are performed when the ECR subject matter may impact other subsystems. The ECR requestor indicates whether it is a one-time change or if the change is to be incorporated into the design documents. Refer to section 7.5 for more information on this process. This design change control process is applicable to design changes that may occur during fabrication and for which the change must be expedited to avoid schedule delays. These types of changes do not affect technical scope, cost, or schedule. For changes that affect these aspects, the change control process is defined in sections 2.4.3 and 3.4.3.

## 9.7 Design

The DUNE design process provides appropriate control of design inputs and design products. The primary design inputs are the DUNE scientific and engineering requirements (e.g., physics requirements, detector requirements, specifications, drawings, engineering reports) as discussed in section A.3.

The basis of the design process requires sound engineering judgment and practices, adherence to scientific principles, and use of applicable orders, codes, and standards. This basis of the design process naturally incorporates environment, health, and safety concerns.

### 9.7.1 Design process

The LBNF/DUNE Systems Engineering website documentation defines the scope of design work for any given scientific/engineering work group. From this source, work groups will begin preliminary design of DUNE by breaking their work down into sets of engineering drawings, specifications and reports. This is the design output.

Throughout the design process, engineers and designers work with consortium leaders and the LBNF/DUNE QA manager to determine QA inspection criteria of fabricated products and installations. Close coordination must be made with DUNE scientists to assure the engineering satisfies the scientific requirements of the experiment. Configuration management as documented in the LBNF/DUNE CMP [1] will be systematically implemented for DUNE. Final Design work sets the final QA parameters for the parts, assemblies and installations. Design during final design and production is confined to change-controlled changes, as above, and to minor changes necessary to facilitate production, drawing error correction, material substitutions and similar functional areas.

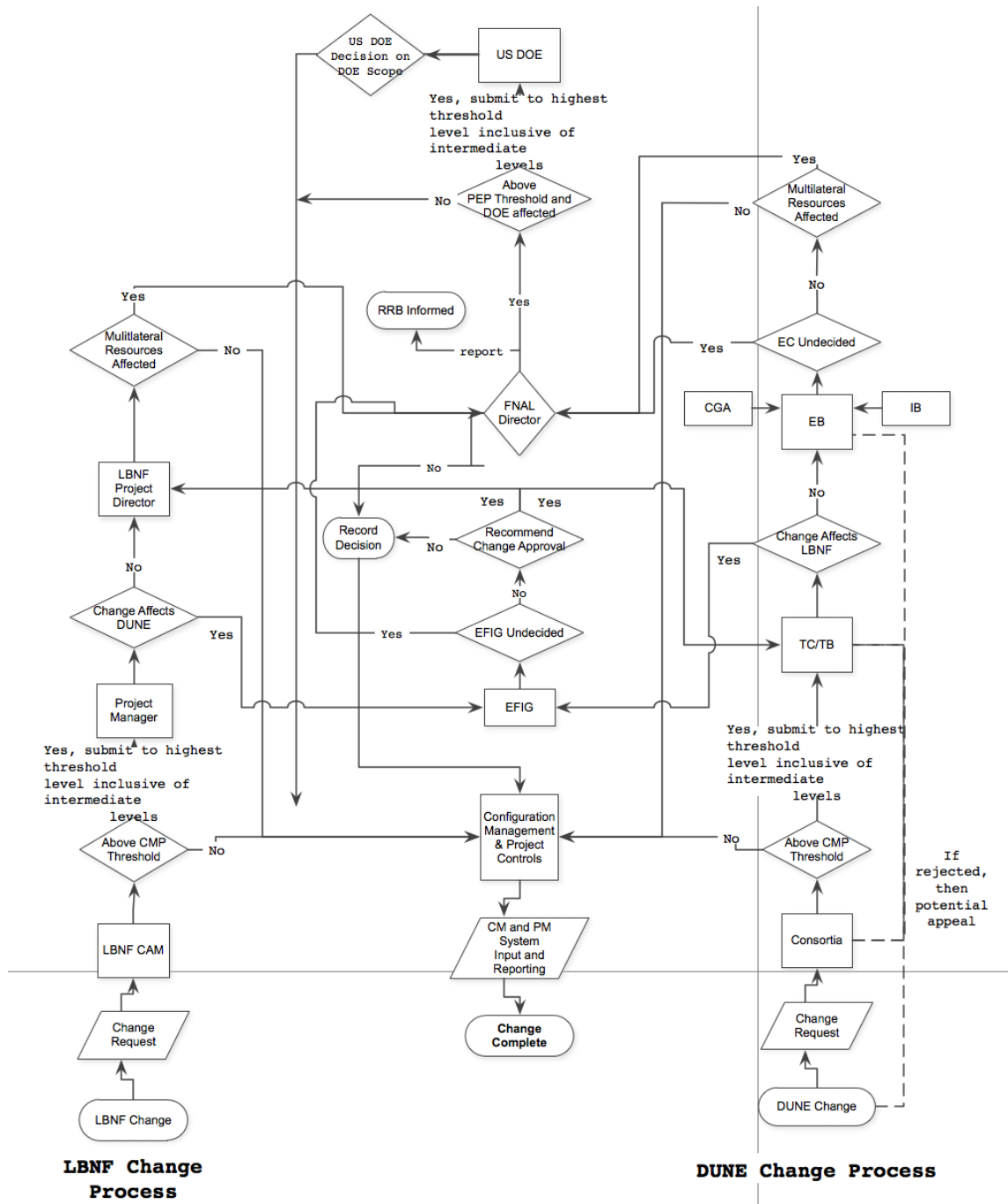

Figure 9.3. LBNF/DUNE preliminary change control flow chart.

### 9.7.2 Design verification and validation

Design is verified and validated to an extent commensurate with its importance to safety, complexity of design, degree of standardization, state of the art, and similarity to proven design approaches. Acceptable verification methods include but are not limited to any one or a combination of (1) design reviews, (2) alternative calculations, and (3) prototype, qualification testing, and/or (4) comparison of the new design with a similar proven design if available. Verification work must be completed before approval and implementation of the design.

Design reviews will verify and validate that the following criteria are met at the appropriate milestone:

- adherence to requirements,
- technical adequacy of the design,
- adequacy of work instructions,
- thoroughness of specifications,
- test results,
- adequacy of technical reports,
- adequacy of design calculations and drawings,
- reliability and maintainability, and
- calibration program for measurement and test equipment.

The DUNE Review Plan as discussed in chapter 8 describes the design reviews recommended for particular consortia.

Wherever the design method involves the use of computer software to make engineering calculations or static dynamic models of the structure, system, or a component's functionality, the software must be verified to demonstrate that the software produces valid results. The verification must be documented in a formal report of validation that is maintained in records that are accessible for inspection. However, exemptions may be made for commercially available software that is widely used and for codes with an extensive history of refinement and use by multiple institutions. Exemptions affecting systems or components will be identified to the LBNF/DUNE Systems Engineering team.

Critical software and firmware computer codes, especially those codes that are involved in controlling DUNE DAQ, are also subject to reviews for verification and validation. Some items to be considered during computer code review are

- adequacy of code testing scheme,
- code release control and configuration management,
- output data verification against code configuration,

- verification that code meets applicable standards,
- verification of code compatibility to other systems that use the data,
- verification that code meets applicable hardware requirements,
- adequacy of code maintenance plans, and
- adequacy of code and data backup systems.

Validation ensures that any given design product conforms to DUNE requirements. During reviews, validation of conformity to requirements follows verification that the engineering design or computer code meets all criteria. Engineering designs and computer codes are validated, preferably before procurement, manufacture, or construction; but no later than acceptance and use of the item; this is to ensure the design or computer code

- meets DUNE requirements,
- contains or makes reference to acceptance criteria, and
- identifies all characteristics crucial to the safe and proper use of the equipment or system and its associated interfaces.

Each inspection, test, or review will feed the QA evaluation process, which is a comparison of results with acceptance criteria, to determine acceptance or rejection. Rejection identifies the need for Quality Improvement based on section 9.4. In some cases, the outcome of the Quality Improvement process may be to request one or more changes to the design requirements.

QA reporting formality escalates as the significance of the inspection, test or review nonconformance increases. Higher levels of management must be aware of and participate in the correction of the most significant nonconformance. Section 9.4 identifies the required course of action when nonconformance is encountered.

## **9.8 Procurement**

### **9.8.1 Procurement controls**

Procurement controls will be implemented to ensure that purchased items and services meet DUNE requirements and comply with the LBNF/DUNE QA plan. The consortium members requesting procurement of items and services are responsible for providing all documentation that adequately describes the item or service being procured so that the supplier can understand the requirements for consortium acceptance. Development of this documentation may be achieved through the involvement of consortium leaders and established review and approval systems. The following factors will be considered for review and approval of this documentation:

- inclusion of technical performance requirements;
- identification of required codes and standards, laws and regulations;

- inclusion of acceptance criteria, including requirements for receiving inspection and/or source inspection;
- DUNE requirements for vendor qualifications and certifications;
- DUNE intention to perform acceptance sampling in lieu of full inspection and test item acceptance.

NOTE: for vendor qualification and acceptance of purchased items or material by consortium members this may be performed under their own institution requirements.

Previously accepted suppliers will be monitored to ensure that they continue supplying acceptable items and services. Source surveillance is the recommended method to ensure that items are free of damage and that specified requirements are met. Supplier deliveries will be verified against previously established acceptance criteria.

Unacceptable supplier items or services will be documented. Records of supplier performance, Inspection Test Records (ITR), and contract-required submittals, are kept for future procurement consideration.

Inspections will be conducted to detect counterfeit and/or suspect parts. For work funded by DOE, when counterfeit or suspect parts are found, they will be identified, segregated, and disposed of in accordance with the Fermilab Quality Assurance Manual Chapter 12020 Suspect/Counterfeit Items (S/CI) Program. DUNE consortia may use their own institutional procedure for counterfeit/suspect parts.

### **9.8.2 Inspection and acceptance testing**

Inspection and testing of electrical, mechanical, and structural components, and associated services and processes by consortium members will be conducted using acceptance and performance criteria. ITR forms, travelers, and a traveler database are the primary tools used to organize this activity. Inspections will be conducted in accordance with the graded approach.

Once equipment is received at SDWF, the equipment is inspected for shipping damage and accuracy against the bill of lading. Consortium members perform any additional inspection and testing that is required by their design documents either at SDWF or underground in the clean room as the equipment is prepared for installation.

Equipment used for all inspections and tests will be calibrated and maintained. Calibration will be controlled by a system or systems making appropriate use of qualified calibration service providers. Consortium leaders must ensure that equipment requiring calibration have their calibration status identified on the item or container, are traceable back to the calibration documentation, and are tracked to ensure the equipment is calibrated at the required interval. The LBNF/DUNE QA manager oversees and supports the DUNE calibration programs.

## **9.9 Assessments**

### **9.9.1 Management assessments**

Management assessments may be performed by the consortia or technical coordination to evaluate their own management processes (self-assessment) and their implementation in order to identify

noteworthy practices, uncover issues, identify corrective actions, verify meeting of deliverables, and ensure that work being performed is satisfactory and done according to the requirements. The performance of management assessments is a critical assurance activity.

DUNE technical coordination will monitor progress of objectives and goals in the consortia to assess whether work is performed and resources are allocated to meet those objectives and goals. DUNE technical coordination is responsible for monitoring the resolution of items identified from assessments, assigning responsibility for resolution, identifying appropriate timeframes for resolution, ensuring actions are finalized with appropriate objective evidence, and documented.

The LBNF/DUNE QA manager monitors adequacy of assessments and progress of corrective actions, and sponsors or conducts periodic assessments of the effectiveness of implementation of the QA program throughout the DUNE project.

### **9.9.2 Independent assessments**

The LBNF/DUNE QA manager will plan reviews as independent assessments to assist the DUNE TC in identifying opportunities for quality or performance-based improvement, and to ensure compliance with specified requirements. Independent assessments of the DUNE projects can be requested by DUNE management. Independent assessments typically focus on quality or ES&H management systems, self-assessment programs, or other organizational functions identified by management. The DUNE project uses a formal process for assigning responsibility in response to recommendations from independent assessments. These recommendations are tracked to closure.

Personnel conducting independent assessments must be technically qualified and knowledgeable in the areas assessed. A qualified lead assessor (auditor), who is a Subject Matter Expert (SME) in the technical area of assessment, is required. The team may include other SMEs to evaluate the adequacy and effectiveness of activities only if they are not responsible for the work being assessed.

The Fermilab director appoints an independent Long Baseline Neutrino Committee (LBNC) to advise it and DUNE Management. The role of this standing committee is described in the LBNF/DUNE project management plan (PMP). The DOE and other funding agencies perform external assessments that provide an objective view of performance and thus contribute to the independent assessment process. Since such assessments are not under the control of DUNE, they are not necessarily considered a part of the independent assessment criterion. However, DUNE management considers external assessment results when determining the scope and schedule of independent assessments.

### **9.10 DUNE quality control**

The DUNE consortia are a geographically diverse group of institutions, collaborating across three continents to fabricate a single integrated system. As such, careful planning and control of component fabrication, assembly and testing must be maintained. Each of the major system components will be fabricated in accordance with documented procedures and drawings. These procedures will detail the inspection and test requirements for each component to ensure that they meet the requisite specifications prior shipment to SURF. Each consortium is responsible for developing the procedures, QC plans, and test plans.



Required inspections and tests during fabrication and installation are defined in the consortium TDR sections. These inspections and tests may be performed from receipt of material, during fabrication and final acceptance. For critical equipment source inspection may be performed in addition. The inspections and tests will be documented on QC plans, travelers, test reports, as applicable. The procedures will define the documentation method.

All data from the fabrication and QC processes will be maintained in a database that allows the information to be accessed during installation. Each consortium will define the requirements for the information to be stored in the database. The consortium TDR sections contain information on how they are utilizing the database.

In the case of a nonconformance, the nonconformance will be documented by the fabrication facility and a recommended disposition will be provided and forwarded to the consortium technical lead. If the disposition is to scrap or rework so that the item meets the requirements of the specification, the notification to the consortium lead will be for information only, and work can continue on performing the disposition. If the disposition is “use as is” or “repair” (where the item is repaired to meet the functionality but remains in noncompliance with the specification requirements), work on the item stops until the disposition has been approved by the design authority, the consortium technical lead and the TC. The TC approves the disposition to ensure it does not affect any other DUNE components during integration. The item will be re-inspected or tested after completion of the disposition to ensure that it meets the requirements.

#### **9.10.1 APA quality control**

Flatness of the APA support frame is a key feature and is defined as the minimum distance between the two parallel planes that contain all the points on the surface of the APA. After assembly of the APA frame, a laser survey is performed on the bare frames before delivery to an APA production site. Three sets of data are compiled into a map that shows the amount of bow, twist, and fold in the frame. A visual file is also created for each APA from measured data. During APA wiring at the production sites, a final frame survey is completed after installation of all electrical components, and the as-built plane-to-plane separations are measured to verify that the distance between adjacent wire planes meets the tolerances.

Another check performed at the APA production site before the frame is transferred to a winder is necessary to confirm sufficient electrical contact between the mesh sub-panels and the APA support frame. A resistance measurement is taken immediately after mesh panel installation for all 20 panels before wiring begins.

All components require inspection and QC checks before use on an APA. Most of these tests will be performed at locations other than the APA production sites by institutions within the consortium before the hardware is shipped for use in APA construction. This distributed model for component production and QC is key to enabling the efficient assembly of APAs at the production sites. The critical path components are the support frames (one per APA), grounding mesh panels (20 per APA), and wire carrier boards (204 per APA).

The tension of every wire will be measured during production to ensure that wires have a low probability of breaking or moving excessively in the detector. Every channel on the completed anode plane assemblies will also be tested for continuity across the APA and isolation from other channels.

A cold testing facility sized for DUNE APAs exists at the Physical Sciences Laboratory (PSL) at the University of Wisconsin that can be used for such tests. Throughout the construction project, it is anticipated that 10% of the produced anode plane assemblies will be shipped to PSL for cold cycling. This amounts to about one APA per year per production site during the project. All anode plane assemblies will still be cold tested during integration at SURF and before installation in the SP module. All active detector components are shipped to the SDWF before final transport to SURF. During the storage period, the wire tensions are measured on all anode plane assemblies to ensure that the transport has not damaged the wires.

After unpacking an APA, a visual inspection is performed, and wire continuity and tension are measured again. Definite guidance for the acceptable tension values will be available to inform decisions on the quality of the APA. Clear pass/fail criteria will be provided as well as clear procedures to deal with individual wires lying outside the acceptable values. In addition, a continuity test and a leakage current test is performed on all channels and the data recorded in the database.

### 9.10.2 HV quality control

The HV consortium has developed a comprehensive QC plan for the production, shipping, and installation of the SP module HV components. Inventory tagging and tracking each component is crucial. Documentation in the form of printed checklists is maintained. Travelers will have been replaced by a system of tags (“cattle tags”) attached to the units with bar codes that key to electronic QC data.

Power supplies used in a SP module are tested before installation. Output voltages and currents must be checked on a known load. The feedthrough and filters are tested at the same time, with the planned power supply. The feedthrough must be verified to hold the required voltage in TPC-quality LAr for several days.

The QC tests of the HVDBs require that all individual resistors and varistors are submitted to a warm and cold (87 K) current-voltage measurement. This forms the basis for selecting components that meet specifications; all electrical components must pass visual inspection for mechanical damage and all measurement values (resistance, clamping voltage) must be within  $2\sigma$  of the mean for the entire sample both in warm and cold tests.

The QC process for mechanical components starts at the production factories by attaching a cattle tag with a unique code to each production element. A file linked to each code contains the individual measurements and properties contained in the QC checklists for that element.

### 9.10.3 TPC electronics quality control

All ASICs will be tested in LN<sub>2</sub> before they are mounted on the FEMBs; cryogenic testing of the FEMBs is also planned. Capacitors and resistors will be cryogenically tested on a sample basis of a few components from each reel. Some other components installed on the FEMBs, e.g., voltage regulators and crystals, will be qualified in LN<sub>2</sub> before being mounted on the FEMBs.

The PCBs for the FEMBs will be tested by the vendor for electrical continuity and shorts. A visual inspection of the boards is then performed before installing the discrete components and the ASICs. This inspection is repeated after installation and before the functionality test, which

for DUNE will be performed in LN<sub>2</sub>. After assembly, each FEMB is tested in LN<sub>2</sub> using the current CTS.

Checks will be performed on all cables during production at room temperature, before installation and connection to the FEMBs. These tests involve continuity and resistance measurements on the low voltage power and the bias voltage cables, and bit-error rate measurements on the clock/control and data readout cables. Connectors will be visually inspected to ensure that they show no sign of damage. Further tests will take place when the APAs are tested in the cold boxes at SURF prior to installation inside the cryostat.

On each cryostat penetration there are two flanges for the CE and one for the PD system. The crossing tubes with their spool pieces are fabricated by industry and tested by vendors to be leak and pressure proof. The flanges are assembled at consortium institutions responsible for the TPC electronics and PD system; the flanges must undergo both electrical and mechanical tests to ensure their functionality. Electrical tests comprise checking all the signals and voltages to ensure they are passed properly between the two sides of the flange and that no shorts exist. Mechanical tests involve checking that the flange itself is leak and pressure proof.

### 9.10.4 PD quality control

Materials certification is required (in the Fermilab materials test stand and other facilities) to ensure materials' compliance with cleanliness requirements. Cryogenic testing of all materials to be immersed in LAr is done to ensure satisfactory performance through repeated and long-term exposure to LAr. Special attention will be paid to cryogenic behavior of fused silica and plastic materials (such as filter plates and wavelength-shifters), silicon photomultipliers (SiPMs), cables, and connectors. Testing will be conducted both on small-scale test assemblies (such as the small test cryostat at Colorado State University (CSU)) and full-scale prototypes (such as the full-scale CDDF cryostat at CSU). Mechanical interface testing, beginning with simple mechanical go/no-go gauge tests, followed by installation into the ProtoDUNE-SP-2 system, and finally full-scale interface testing of the PD system into the final pre-production TPC system models will be done; as well as full-system readout tests of the PD readout electronics, including trigger generation and timing, and tests for electrical interference between the TPC and PD signals.

Prior to the start of fabrication, a manufacturing and QC plan will be developed detailing the key manufacturing, inspection, and test steps. The fabrication, inspection, and testing of the components will be performed in accordance with documented procedures. This work will be documented on travelers and applicable test or inspection reports. Records of the fabrication, inspection and testing will be maintained. When a component has been identified as being in noncompliance to the design, the nonconforming condition will be documented, evaluated and dispositioned as one of (1) use-as-is (does not meet design but can meet functionality as it is), (2) rework (bring into compliance with design), (3) repair (will be brought to meet functionality but will not meet design), or (4) scrap. For products with a disposition of use-as-is or repair, the nonconformance documentation is submitted to the design authority for approval. All QC data (from assembly and pre- and post-installation into the APA) will be directly stored to the DUNE database for ready access.

Monthly summaries of key performance metrics (to be defined) will be generated and inspected to check for quality trends. Based on the ProtoDUNE-SP model, we expect to conduct the following production testing prior to shipping from assembly site.

- dimensional checks of critical components and completed assemblies to ensure that system interfaces are satisfactory;
- post-assembly cryogenic checkouts of SiPM mounting PCBs (prior to assembly into PD modules);
- module dimensional tolerances using go/no-go gauge set; and
- warm scan of complete module using motor-driven LED scanner (or UV LED array).

Following shipping to the USA reception and checkout facility but prior to storage at SDWF, we will conduct mechanical inspection, a warm scan (using identical scanner to initial scan), and cryogenic testing of completed modules (at the CSU CDDF or similar facility).

Following delivery to the underground integration cleanroom, prior to and during integration and Installation, we will

- conduct a warm scan (using identical scanner to initial scan);
- complete visual inspection of module against a standard set of inspection points, with photographic records kept for each module;
- conduct end-to-end cable continuity and short circuit tests of assembled cables;
- perform a FE electronics functionality check;
- perform installation QC PD system pre-installation testing, following the model established for ProtoDUNE-SP.

Prior to installation in the APA, the PD modules will undergo a warm scan in a scanner identical to the one at the PD module assembly facility and we will compare the results. The module will also undergo a complete visual inspection for defects, and a set of photographs of selected critical optical surfaces will be taken and entered into the QC record database. Following installation into the APA and cabling, an immediate check for electrical continuity to the SiPMs will be conducted. Following the mounting of the TPC CE and the PDs, the entire APA will undergo a cold system test in a gaseous argon cold box, similar to that performed for ProtoDUNE-SP. During this test and prior to installation, the PD system will undergo a final integrated system check, checking dark and LED-stimulated SiPM performance for all channels, checking for electrical interference with the CE, and confirming compliance with the detector grounding scheme.

### 9.10.5 Calibration quality control

The manufacturer and the institutions in charge of devices will conduct series of tests to ensure the equipment can perform its intended function as part of QC. QC also includes post-fabrication tests and tests run after shipping and installation. The overall strategy for the calibration devices is to test the systems for correct and safe operation first in dedicated test stands, then at ProtoDUNE-SP-2, then as appropriate near SURF, and finally underground. Electronics and racks associated with each full system will be tested before transporting them underground. Each calibration system undergoes specific tests.

- **Ionization Laser System:** for assembly and operation of the laser and feedthrough interface, the test is carried out on a mock-up flange for each of the full hardware sets (periscope, feedthrough, laser, power supply, and electronics). All operational parts (UV laser, red alignment laser, trigger photodiode, attenuator, diaphragm, movement motors, and encoders) are tested for functionality before being transported underground.
- **Photoelectron Laser System:** the crucial test is to measure the light transmission of all fibers at 266 nm. A suitable transmission acceptance threshold will be established based on studies during the development phase. Studies to estimate the number of photoelectrons emitted as a function of intensity (based on distance of fiber output to the metallic tab) will also be undertaken.
- **Laser Beam Location System:** for the laser beam location system (LBLS), to ensure uniformity across all clusters, the main test is to verify that the PIN diodes are all functional and that their light detection efficiency is within a specified range. For the mirror-based system, the reflectivity of all mirrors will be tested prior to assembly.
- **Pulsed Neutron Source System:** the first test will be safe operation of the system in a member institution radiation-safe facility. Then the system will be validated at ProtoDUNE-SP-2. The same procedure will be carried out for any subsequent devices before the devices are transported to SURF and underground. System operation will be tested with shielding assembled to confirm safe operating conditions and sufficient neutron yields using an external dosimeter as well as with the installed neutron monitor.

### 9.10.6 DAQ quality control

SP-DAQ-6 Data verification: the DAQ must check integrity of data at every data transfer step. It only deletes data from the local storage after confirmation that data have been correctly recorded to permanent storage. Data integrity checking is fundamental to ensure data quality. The high overall experiment uptime goal requires that the DAQ be stringently designed for reliability, fault tolerance, and redundancy — criteria that aim to reduce overall downtime. The DAQ monitors the quality of the detector data and of its own operational status, performs automated error detection, and has recovery capabilities.

The event builder (EB) subsystem provides bookkeeping functionality for the raw data. This includes the documenting of simple mappings, such as which trigger is stored in which raw data file, as well as more sophisticated quality checks. For example, it will know which time windows and geographic regions of the detector are requested for each trigger, and in the unlikely event that some fraction of the requested detector data cannot be stored in the event record, it will document that mismatch.

Data Quality Monitoring: while the DAQ control, configuration and monitoring subsystem (CCM) contains an element of monitoring, here data quality monitoring (DQM) refers to a subsystem that quickly analyzes the data in order to determine the general quality of the detector and DAQ operation. This allows operators to promptly detect and respond to any unexpected changes and assures high exposure times for later physics analyses.

A DAQ DQM will be developed (including necessary infrastructure, visualization, and algorithms) that processes a subset of detector data in order to provide prompt feedback to the detector operators. This system will be designed to allow it to evolve as the detector and its data are understood during commissioning and early operation, and to cope with any evolution of detector conditions.

While the hardware design will be done at the institutions working in this area, the production of prototypes and final PCBs will be outsourced to companies, allowing for early identification of those companies that can guarantee a high-quality card production.

### 9.10.7 CISC quality control

The manufacturer and the institution in charge of device assembly will conduct a series of tests to ensure the equipment can perform its intended function as part of QC. QC also includes post fabrication tests and tests run after shipping and installation. For complex systems, the entire system will be tested before shipping. Additional QC procedures can be performed underground after installation.

Slow Controls Hardware Networking and computing systems will be purchased commercially, requiring QC. However, the new servers are tested after delivery to confirm they suffered no damage during shipping. The new system is allowed to burn in overnight or for a few days, running a diagnostics suite on a loop in order to validate the manufacturer's QA process.

### 9.11 ProtoDUNE to DUNE QA approach

The approach to quality assurance (QA)/quality control (QC) for DUNE is going to be very similar to the activities and oversight that was performed for ProtoDUNE. For ProtoDUNE, the major QA/QC activities included review of the consortium TDR QA/QC sections; assisting the consortia in development and review of QC plans (production and installation), fabrication, inspection and test procedures, installation plans and documentation; and the performance of production readiness reviews at eleven consortium fabrication facilities. There was also QC participation in the ProtoDUNE design reviews. The production readiness reviews looked at the following criteria:

- final QA plans for institutions not adopting the LBNF/DUNE QA Plan;
- final production drawings, specifications, and manufacturing and test procedures;
- final safety documents (i.e., hazard analysis documentation);
- component QC plan (i.e., travelers, test reports, software verification and validation documents, supplier documentation);
- final procurement documents per institution practice; and
- completion and evaluation of prototypes, and review of production process and QC results.

The reviews ensured the facilities were prepared for production and that any kinks in the processes had been identified and mitigations performed. The positive outcome of these reviews was the amount of equipment received at CERN with little to no damage.

Production progress reviews will be performed at the fabrication facilities for the DUNE detector components. This type of review has been added due to the larger number of components required and the increased number of fabrication facilities. The goal of these reviews is to ensure consistent fabrication processes between the facilities. If an issue is identified at one facility, it can be communicated to others to prevent recurrence.

For ProtoDUNE, installation was performed at CERN under the guidance of CERN policies and procedures. Installation of the DUNE detector modules at SURF will fall under similar procedures in the LBNF/DUNE QA plan.

## Chapter 10

# Environment, safety, and health

LBNF/DUNE is committed to protecting the health and safety of staff, the community, and the environment, as stated in the LBNF/DUNE integrated ES&H plan, as well as to ensuring a safe work environment for DUNE workers at all institutions and protecting the public from hazards associated with constructing and operating DUNE. Accidents and injuries are preventable, and the ES&H team will work with the global LBNF/DUNE project and collaboration to establish an injury-free workplace. All work will be performed so as to preserve the quality of the environment and prevent property damage.

The LBNF/DUNE ES&H program complies with applicable standards and local, state, federal, and international legal requirements through the Fermilab Work Smart set of standards and the contract between Fermi Research Alliance (FRA) and the DOE Office of Science (FRA-DOE). Fermilab, as the host laboratory, established the SDSD to provide facility support. SDSD is responsible for support of LBNF/DUNE operations at SURF.

The LBNF/DUNE ES&H program strives to prevent injuries or illness and seeks to continually improve safety and health management. To the maximum practical extent, all hazards must be eliminated or minimized through substitution, or engineering or administrative controls. Where engineering or administrative controls are not feasible, workers will use PPE.

The LBNF/DUNE ES&H management system is designed to work hand-in-hand with the SURF emergency management systems to protect the public, workers, and the environment; ensure compliance with the FRA-DOE contract and Fermilab Work Smart standards; and improve the DUNE ability to meet or exceed stakeholder expectations and execute the scientific mission. DUNE uses a set of criteria to plan, direct, control, coordinate, assure, and improve how ES&H policies, objectives, processes, and procedures are established, implemented, monitored and achieved.

The LBNF facilities at SURF are subject to the requirements of the DOE Worker Safety and Health Program, Title 10, Code Federal Regulations, Part 851 (10 CFR 851). These requirements are promulgated through the Fermilab Director Policy Manual,<sup>1</sup> and the Fermilab ES&H Manual<sup>2</sup> (Fermilab Environment, Safety and Health Manual (FESHM)), which align with the SURF ES&H manual.

---

<sup>1</sup>Fermilab Director's Policy Manual is: [http://www.fnal.gov/directorate/Policy\\_Manual.html](http://www.fnal.gov/directorate/Policy_Manual.html).

<sup>2</sup>Fermilab ES&H Manual is: <http://esh.fnal.gov/xms/ESHQ-Manuals/feshm>.



## 10.1 LBNF/DUNE ES&H management and oversight

The TC and project integration director have responsibility for implementation of the DUNE ES&H program for the construction and installation activities, respectively. The LBNF/DUNE ES&H manager reports to the TC and project integration director and is responsible for providing ES&H support and oversight for development and implementation of the LBNF/DUNE ES&H program. Figure 2.3 shows the LBNF/DUNE ES&H organization.

The DUNE ES&H coordinator reports to the LBNF/DUNE ES&H manager and has primary responsibility for ES&H support and oversight of the DUNE ES&H program for activities at collaborating institutions as shown in figure 3.4. The far and near site ES&H coordinators are responsible for providing daily field support and oversight for all installation activities at the SURF and Fermilab sites, as shown in figure 4.1.

Additional ES&H subject matter experts (SMEs) are available to provide supplemental support to the project through the Fermilab ES&H section. The Fermilab ES&H section, FRA-DOE, CERN and SURF will provide supplemental ES&H oversight to validate implementation of the LBNF/DUNE ES&H program. FRA-DOE maintains a daily oversight presence at the far and near sites.

The LBNF/DUNE ES&H plan defines the ES&H requirements applicable to installation activities at the SURF site. Regular ES&H walkthroughs will be conducted by LBNF/DUNE ES&H management personnel. All findings will be documented in the Fermilab Predictive Solutions database system.

## 10.2 National Environmental Protection Act compliance

In compliance with the National Environmental Protection Act (NEPA) and in accordance with DOE Policy 451.1, the LBNF/DUNE project performed an assessment of environmental impacts that are possible during the construction and operation of the project. This assessment [12] identifies the potential environmental impacts and the safety and health hazards that could occur or be present during the design, construction, and operating phases of LBNF/DUNE. The environmental assessment presented an analysis of the potential environmental consequences of the facility and compared them to the consequences of a No Action Alternative. It also included a detailed analysis of all potential environmental, safety, and health hazards associated with construction and operation of the facility. The environmental assessment has been completed and a finding of no significant impact (FONSI) [12] issued in September 2015.

## 10.3 Codes/standards equivalencies

DUNE will rely on significant contributions from international partners. In many cases, an international partner will contribute equipment for installation at Fermilab or SURF, built following international standards. Fermilab has established a process under the international agreement with CERN, detailed in FESHM [13] chapter 2110, to establish code equivalency between USA and international engineering design codes and standards. This process allows the laboratory to accept in-kind contributions from international partners or purchase equipment designed using international standards while ensuring an equivalent level of safety.

At the time of this writing, Fermilab has completed the following code equivalencies:

- pressure vessels designed using EN13445;
- structures designed using EN 1990, EN 1991, EN1993, EN 1999 (a subset of the Eurocodes), and EN 14620;
- CE-marked pressure piping systems designed using PED 97/23 EN 13480;
- CE-marked relief valves designed using PED 2014/68/EU EN ISO 4126;
- CE-marked electrical equipment for measurement and control; and laboratory use designed using IEC 61010-1 and IEC 61010-2-030.

As necessary, the laboratory code equivalency process will be followed to establish equivalency to other international codes and standards. The current list of completed code equivalencies can be found in [14].

#### **10.4 ES&H requirements at collaborating laboratories and institutions**

All work performed at collaborating institutions will be completed following that institution's ES&H policies and programs. Equipment and operating procedures provided by the collaborating institution will conform to the DUNE project ES&H and integrated safety management policies and procedures. The ES&H organization at collaborating institutions provides ES&H oversight for work activities carried out at their facilities.

#### **10.5 LBNF/DUNE ES&H program at SURF**

##### **10.5.1 Site and facility access**

All DUNE workers requiring access to the SURF site register through the Fermilab Global Services Office to receive the necessary user training and a Fermilab identification number that can be used to apply for a SURF identification badge, through the SURF Administrative Services Office. This is coordinated by SDSO. The SURF identification badge allows access to the SURF site as part of the SURF Site Access Control Program. The Fermilab Global Services Office has extensive experience with international collaborators.

SURF underground access will require that working groups obtain a trip action plan (TAP) for each daily access to the underground areas. All personnel within each working group must be individually listed on the TAP, per the SURF Site Access Control Program. All personnel are required to "brass in and out" via the brass board located at the entrance to the Ross Cage prior to accessing the underground facilities.

##### **10.5.2 ES&H training**

All personnel performing work onsite at SURF are required to attend SURF ES&H Site Orientation prior to their work at the site. This includes SURF Surface and Underground training classes, as well as associated Cultural Heritage training. Arrangements will be made for all workers to complete this

training. In addition, unescorted-access training will be provided to personnel for each underground working level (4850L and 4910L) at which they will perform work. The LBNF/DUNE ES&H management team will present a project-specific introductory ES&H presentation.

### 10.5.3 Personnel protective equipment

Personal protective equipment (PPE) is not a substitute for engineering and administrative controls. These controls will be implemented, to the extent feasible, to mitigate the hazard so that the need for PPE is reduced or eliminated.

Personnel must wear the following PPE when on site the SURF site.

- At a minimum, all workers personnel shall wear steel-toed boots, long pants and shirts with at least four-inch sleeves when performing non-office work at SURF.
- All personnel entering the work site at the Ross (or Yates) Dry shall wear hard hats (brim facing forward), gloves, safety glasses with rigid side-shields and a reflective high visibility (e.g., orange) shirt, coat, or vest (minimum ANSI Class 2). Exceptions to these minimum requirements will be approved by the LBNF/DUNE ES&H manager and noted in the activity-specific HA maintained by the DUNE ES&H coordinator.
- When working underground, all personnel will carry an Ocenco M20.2 self rescuer and a hard hat cap lamp. Ocenco 7.5 emergency breathing apparatus devices will be stored underground for additional emergency support.
- Hard hats must meet the ANSI Z89.1 standard as defined by 29 CFR 1926.100 and bear the Z89-.1 designation.
- Eye protection must meet the requirement of 29 CFR 1926.102. Safety glasses must be ANSI approved and be marked with the ANSI marking Z87.1 designation.
- Hearing protection must be appropriate to the work environment, as defined in the activity-based HA.
- Workers will don any specialized PPE required for specific work tasks as defined in the activity-based HA.

### 10.5.4 Work planning and controls

The goal of the work planning and controls process is to determine how to do the work safely, correctly, and efficiently. All work activities are subject to the work planning and controls process which includes the development of HA documentation. The first steps are to initiate careful thought about the work, determine the scope of the job, identify the potential hazards associated with it, and determine mitigation strategies. We ensure that all affected employees understand the full work plan and what is expected of them and that they have all the appropriate materials to do the job properly. The Work Planning and HA program is documented in chapter 2060 in the FESHM manual [15]. All work planning documentation is reviewed and approved by line management supervision, the DUNE ES&H coordinator, and the DUNE installation readiness review or operational readiness review committees prior to the start of work activities.

A work planning meeting will be held before each shift. The meeting is led by the shift supervisor, supported by the DUNE ES&H coordinator, and attended by all personnel working on site during that shift. The meeting is intended to inform the workers of potential safety hazards and hazard mitigations relating to the various work activities, ensure that employees have the necessary ES&H training and PPE, answer any questions relating to the work activities, and authorize the work activities for that shift. The meeting is expected to last approximately 15 minutes, but may vary depending on the activities planned for the shift.

A Safety Data Sheet (SDS) will be available for all chemicals and hazardous materials that are used on site. All chemicals and hazardous materials brought to the SURF site must be reviewed and approved by the DUNE ES&H coordinator and the SURF ES&H Department before arriving at site. SDS documentation will be submitted to the DUNE ES&H coordinator prior to the material arriving on site.

### 10.5.5 Emergency management

Any injuries, accidents, or spills are to be reported immediately to the LBNF/DUNE ES&H manager, from either the SURF Emergency Response Coordinator or the installation manager, through the DUNE far site ES&H coordinators and the DUNE ES&H coordinator. Any personnel that experience any injury will be sent (or transported, if needed) to the Black Hills Medical Clinic or Regional Health Lead-Deadwood hospital. The supervisor completes an initial incident investigation report and submits the report to the LBNF/DUNE ES&H manager within 24 hours.

The SURF ES&H Manual<sup>3</sup> maintains the Emergency Management and Emergency Response Plan (ERP)<sup>4</sup> for the site. All personnel will receive ERP training and the ERP flowchart for emergency notification process is posted at all telephones. For all emergencies at the SURF site, personnel contact Emergency Response personnel by using any building phone, dialing the hoist operator, or by calling 911 from any outside line (e.g., cell phone).

Emergency Response Groups that are not part of SURF but are recognized outside resources are the Lawrence County Emergency Manager, the Lead and Deadwood Fire Departments, Lawrence County Search and Rescue, Black Hills Life Flight, and the Rapid City Fire Department HAZMAT team. The SURF ERP is distributed to these resources to facilitate outside emergency response.

SDSTA will maintain an emergency response incident command system and an emergency response team (ERT) on all shifts that can access the underground sites with normal surface fire department response times. This team provides multiple response capabilities for both surface and underground emergencies but specializes in underground rescue through MSHA Metal/Non-Metal Mine Rescue training. The ERT has a defined training schedule and conducts regular walkthroughs in areas of response. The team conducts emergency drills on both the surface and underground sites, in which all personnel on site are required to participate. ERT personnel includes a minimum of one emergency medical technician (EMT) and/or paramedic per shift.

SURF implements a guide program for both the surface and underground areas. The guide program has an established training program. Visitors and other untrained personnel must be escorted by a trained guide when on site at SURF. In addition, a minimum of one guide is stationed

---

<sup>3</sup><http://sanfordlab.org/esh>.

<sup>4</sup><http://sanfordlab.org/esh/manual/32-emergency-response-plan-erp-policy>.

on each level underground at all times where work is occurring. This guide provides supplemental emergency support to unescorted, access-trained personnel. Guides are trained as first responders to help in a medical emergency until the ERT arrives.

In the case of an underground emergency such as fire or ODH, evacuation to the surface takes place through the Ross or Yates Shafts. If full evacuation is not possible, the refuge chamber on the 4850L can shelter up to 144 persons for 98 hours.

### 10.5.6 Fire protection, ODH and life safety

The DUNE installation team members are required to police their work areas frequently and maintain good housekeeping. Teams generating common garbage and other waste must dispose of it at frequent, regular intervals. Containers will be provided for the collection and separation of waste, trash, oily or used rags, and other refuse. Containers used for garbage and other oily, flammable, or hazardous wastes, (e.g., caustics, acids, or harmful dusts) will be equipped with covers. Chemical agents or substances that might react to create a hazardous condition, must be stored and disposed of separately, as assessed by the LBNF/DUNE ES&H coordinator.

The LBNF/DUNE ES&H coordinator collects SDS documentation for chemicals and hazardous materials and determines proper storage cabinets for them. The documentation is made readily available with the materials in the cabinets for the workers.

All open flame, welding, cutting, or grinding work activities require completion and approval of a Fermilab “hot” work permit. The DUNE ES&H coordinator coordinates the issuance of the permit. The team completing the work will be responsible for providing all the required materials, personnel, and PPE to conduct the hot work. All hot work permits must be provided to the SURF ES&H Department.

Cables installed for DUNE are chosen to be consistent with current Fermilab standards for cable insulation and must comply with recognized standards concerning cable fire resistance. This reduces the probability of a fire starting and of adverse health effects due to combustion products of cable insulation materials.

Fire and life safety requirements for LBNF/DUNE areas were analyzed in the LBNF/DUNE Far Site Fire and Life Safety Assessment DocDB 14245 [16]. ARUP provided code analysis, fire modeling, egress calculations, and the design of the fire protection features for LBNF FSCF. Additionally, the ARUP consultant, SRK Consulting, modeled additional fire scenarios and the potential spread of toxic fumes and heat in the drifts used by LBNF/DUNE for evacuation, verifying that the system design and evacuation processes will be safe. All caverns will be equipped with fire detection and suppression systems, with both visual and audible notification. All fire alarms and system supervisory signals will be monitored in the SURF Incident Command Center. The SURF ERT will respond with additional support from the Lead and Deadwood Fire Departments and the county’s emergency management department.

ODH requirements were assessed through the LBNF/DUNE ODH analysis. The caverns have been classified as ODH 1 and the drifts are classified as ODH 0. The caverns will be equipped with an ODH monitoring and alarm system, with independent visual and audible notification systems. All ODH alarms and system supervisory signals will be monitored in the SURF Incident Command Center. Each occupant entering an ODH area will receive ODH training and carry Ocenco M20.3 escape packs.

Emergency conditions from smoke or ODH incidents underground are primarily mitigated by the large ventilation rate in the SURF underground area.

The facility emergency management plan will be reviewed and updated as necessary during construction, installation, and operation activities based on the egress strategy defined in the ARUP Fire and Safety Report and the SURF Emergency Management Plan.<sup>5</sup>

Radon levels are presently monitored in the occupied underground facilities. This monitoring program will extend to the LBNF underground areas in coordination with Fermilab and SDSTA ES&H personnel.

### 10.5.7 Earthquake design standards

For surface and underground structures, the design standard is the latest edition of the International Building Code (IBC) (2018), wherein chapter 16 is Structural Design and section 1613 is Earthquake Loads. The Lead seismic region, according to the American Society of Civil Engineers (ASCE 7), is between the lowest risk (the same as that for Fermilab) and the next level up. Both are minimal risks.

### 10.5.8 Material handling and equipment operation

All overhead cranes, gantry cranes, fork lifts, and motorized equipment, e.g., trains and carts, will be operated only by trained operators. Other equipment, e.g., scissor lifts, pallet jacks, hand tools, and shop equipment, will be operated only by personnel trained for the particular piece of equipment.

Hoisting and rigging operations will be evaluated and planned. A member of the trained rigging team must identify the hazards and determine the controls necessary to maintain an acceptable level of risk. A Hoisting and Rigging Lift Plan is required for complex and critical lifts. This plan must be documented using the Fermilab Hoisting and Rigging Lift Plan or similar plan accepted by Fermilab. The HA documentation will include the development of critical lift plans for specific phases of installation.

All equipment operating in the underground facility will be diesel or electric powered. Diesel is allowed due to the large ventilation rate in the underground area. There will be no gasoline or propane powered equipment in the underground facility.

### 10.5.9 Stop work authority

If a worker identifies any unanticipated or unsafe conditions or non-compliant practices occurring in their work activity, the trained worker is empowered and expected to stop the activity and notify their supervisor and DUNE ES&H coordinator of this action. All workers on the DUNE project have the authority to stop work in any situation that presents an imminent threat to safety, health, or the environment. Work may not resume until the circumstances are investigated and the deficiencies corrected, including the concurrence of the DUNE project integration director and LBNF/DUNE ES&H manager.

---

<sup>5</sup><http://sanfordlab.org/ehs/manual/31-emergency-management-policy>.

#### 10.5.10 Operational readiness

The DUNE review process consists of design, production, installation, and operation reviews as described in chapter 8. These reviews include lifting fixture load testing and work planning and controls documentation. The JPO review office is involved at all stages of the review process. All major stakeholders (including Fermilab, SURF and DUNE collaborating institutions) will be involved as appropriate. The review office will complete both system and process readiness reviews to authorize installation activities at SURF. Operational readiness reviews will be completed prior to the operation of detector components.

#### 10.5.11 Lessons learned

The LBNF project is currently working with SDSTA and the engineering consultant ARUP to implement ES&H procedures and protocols for training, emergency management, fire protection, and life safety. The Fermilab ES&H section, DOE, and LBNF ES&H have completed a series of assessments of critical SDSTA ES&H programs including underground access, emergency management, electrical safety, rigging, and fire protection. The findings and lessons learned identified in these ES&H program assessments are tracked within the Fermilab issues management database, iTrack.

Fermilab completed a review to identify critical lessons learned from the previous underground neutrino project NuMI/MINOS in May 2009. The findings from this exercise were documented in a report entitled Executive Summary of Major NuMI Lessons Learned. We are using the DUNE lessons learned from ProtoDUNE to further develop and enhance the DUNE engineering review and work planning and controls processes.

Lessons learned are disseminated in areas of applicability and flowed-down for appropriate implementation. Any action items associated with lessons learned are tracked in iTrack. Lessons learned are reviewed and evaluated by both Fermilab and LBNF/DUNE management.

## Appendix A

# Project document summary

### A.1 Interface documents

A set of interface documents defines the scope of each subsystem and with progressively more detail defines the detailed interfaces between subsystems. There are three sets of interface documents. One set of documents includes all of the consortia-to-consortia interfaces. A second set includes the interfaces between the consortia and the facilities (provided either by technical coordination, LBNF or the integration office). The third set is between the consortia and the installation team. All three sets are managed by JPO engineering team.

The DUNE interface documents are actively maintained in the EDMS, but a copy has been archived in DocDB that captures the status of these documents at the time of this TDR. A matrix with links to the interface documents in DocDB between consortia for the SP module are shown in table A.1. The interface documents for the DP module are in preparation as of this writing.

**Table A.1.** SP module consortium-to-consortium interface document matrix. All entries point to documents in the DUNE DocDB.

	PDS	TPC Elec	HV	DAQ	CISC	CAL	COMP
APA	[17]	[18]	[19]	[20]	[21]	[22]	[23]
PDS		[24]	[25]	[26]	[27]	[28]	[29]
TPC Elec			[30]	[31]	[32]	[33]	[34]
HV				[35]	[36]	[37]	[38]
DAQ					[39]	[40]	[41]
CISC						[42]	[43]
CAL							[44]

A matrix with links to the interface documents in DocDB between each consortium and the facility, installation, and DUNE physics for the SP module are shown in table A.2.



**Table A.2.** SP module consortium-to-TC interface document matrix. All entries point to documents in the DUNE DocDB.

	APA	PDS	TPC Elec	HV	DAQ	CISC	CAL	COMP
Facility	[45]	[46]	[47]	[48]	[49]	[50]	[51]	[52]
Installation	[53]	[54]	[55]	[56]	[57]	[58]	[59]	[60]
Physics	[61]	[62]	[63]	[64]	[65]	[66]	[67]	[68]

## A.2 Schedule milestones

A series of tiered milestones have been developed for the DUNE project. The spokespersons and host laboratory director are responsible for the tier 0 milestones. Three tier 0 milestones have been defined and the dates set:

1. Start main cavern excavation 2020
2. Start detector module 1 installation 2024
3. Start operations of detector modules #1–2 with beam 2028

These dates will be revisited after the U.S. LBNF project is reviewed. The TC, project integration director and LBNF project manager hold the tier 1 milestones. The consortia hold tier 2 milestones. Table A.3 provides a high level version of the DUNE milestones from the LBNF/DUNE schedule.

To monitor progress, JPO scheduling team will maintain the LBNF/DUNE schedule that links all consortium schedules and contains milestones for each consortia. The schedules will go under change control after each consortium agrees to the milestone dates, the TDR is approved, and the LBNF project is baselined.

To ensure that the DUNE detector remains on schedule, technical coordination will monitor schedule status from each consortium and organize reviews of schedules and risks as appropriate. As schedule problems arise, technical coordination will work with the affected consortium to resolve the problems. If problems cannot be solved, the TC will take the issue to the TB and EB.

A monthly report with input from all the consortia will be published by technical coordination and provided to the LBNC. This will include updates on consortium and technical coordination technical progress against the schedule.

## A.3 Requirements

The scientific goals of DUNE as described in Volume I: Introduction to DUNE of this TDR include

- a comprehensive program of neutrino oscillation measurements including the search for charge-parity symmetry violation (CPV);
- measurement of  $\nu_e$  flux from a core-collapse supernova within our galaxy, should one occur during DUNE operations; and
- a search for baryon number violation.

**Table A.3.** DUNE schedule milestones for first two far detector modules. Key DUNE dates and milestones, defined for planning purposes in this TDR, are shown in orange. Dates will be finalized following establishment of the international project baseline.

Milestone	Date
Final design reviews	2020
Start of APA production	August 2020
Start photosensor procurement	July 2021
Start TPC electronics procurement	December 2021
Production readiness reviews	2022
South Dakota Logistics Warehouse available	April 2022
Start of ASIC/FEMB production	May 2022
Start of DAQ server procurement	September 2022
Beneficial occupancy of cavern 1 and CUC	October 2022
Finish assembly of initial PD modules (80)	March 2023
CUC DAQ room available	April 2023
Start of DAQ installation	May 2023
Start of FC production for detector module #1	September 2023
Start of CPA production for detector module #1	December 2023
Top of detector module #1 cryostat accessible	January 2024
Start TPC electronics installation on top of detector module #1	April 2024
Start FEMB installation on APAs for detector module #1	August 2024
Start of detector module #1 TPC installation	August 2024
Top of detector module #2 cryostat accessible	January 2025
Complete FEMB installation on APAs for detector module #1	March 2025
End DAQ installation	May 2025
End of detector module #1 TPC installation	May 2025
Start of detector module #2 TPC installation	August 2025
End of FC production for detector module #1	January 2026
End of APA production for detector module #1	April 2026
End detector module #2 TPC installation	May 2026
Start detector module #1 operations	July 2026

These goals motivate a number of key detector requirements: drift field, electron lifetime, system noise, photon detector light yield and time resolution. The EB has approved a list of high-level detector specifications, including those listed above. These will be maintained in EDMS, and the high-level requirements with significant impact on physics (applying to both SP and DP detector modules are highlighted in table A.4.

**Table A.4.** DUNE physics-related specifications owned by EB.

ID	System	Parameter	Physics Requirement Driver	Requirement	Goal
1	HVS	Minimum drift field	Limit recombination, diffusion and space charge impacts on particle ID. Establish adequate signal-to-noise (S/N) for tracking.	>250 V/cm	500 V/cm
2	TPC Elec	System noise	The noise specification is driven by pattern recognition and two-track separation.	<1000 enc	ALARA
3	PDS	Light yield	The light yield shall be sufficient to measure time of events with visible energy above 200 MeV. Goal is 10% energy measurement for visible energy of 10 MeV.	>0.5 pe/MeV	>5 pe/MeV
4	PDS	Time resolution	The time resolution of the photon detection system shall be sufficient to assign a unique event time.	< 1 $\mu$ s	< 100 ns
5	all	liquid argon purity	The LAr purity shall be sufficient to enable drift e- lifetime of 3 (10)ms	< 100 ppt	< 30 ppt

Eleven other significant specifications for the SP module owned by the EB are listed in table A.5 along with another twelve high-level engineering specifications.

The high level DUNE requirements that drive the LBNF design are maintained in DocDB 112 [69] and under change control. These are owned by the DUNE TC and LBNF project manager.

Lower level detector specifications are held by the consortia and described in the DUNE TDR Volumes IV, The DUNE far detector single-phase technology, and V, The DUNE Far Detector Dual-Phase Technology. A complete list of detector specifications is provided in section A.4.

**Table A.5.** DUNE high-level system specifications owned by EB.

ID	System	Parameter	Physics Requirement Driver	Requirement	Goal
6	APA	Gaps between APAs	minimize events lost due to vertex in gaps between APAs (15mm on same support beam, 30mm on adjacent beams)	<30 mm	<15 mm
7	DSS	Drift field uniformity	tolerance on drift field due to component location	< 1 %	
8	APA	wire angles	0° collection, ±35.7° induction		
9	APA	wire spacing	4.669 mm for U,V; 4.790 mm for X,G		
10	APA	wire position tolerance		± 0.5 mm	
11	HVS	Drift field uniformity	tolerance on drift field due to HVS system	< 1 %	
12	HVS	Cathode power supply ripple	very small compared to intrinsic electronics noise	< 100 enc	
13	TPC Elec	Front end peaking time	optimize vertex resolution	1 μs	
14	TPC Elec	Signal saturation	largest signals occur with multiple protons in the primary vertex	500k e <sup>-</sup>	
15	cryo	LAr N <sub>2</sub> contamination	optical attenuation length in liquid argon with 50 ppm of N <sub>2</sub> contamination is roughly 3 m	< 25 ppm	
29	all	Detector uptime	risk of missing a supernova burst	< 98 %	< 99 %
30	all	Individual detector module uptime	meet physics goals in timely fashion	< 90 %	< 95 %

## A.4 Full DUNE requirements

### A.4.1 Single-phase

**Table A.6:** Specifications for SP-FD.

Label	Description	Specification (Goal)	Rationale	Validation
SP-FD-1	Minimum drift field	> 250 V/cm (> 500 V/cm)	Lessens impacts of $e^-$ -Ar recombination, $e^-$ lifetime, $e^-$ diffusion and space charge.	ProtoDUNE
SP-FD-2	System noise	< 1000 $e^-$	Provides >5:1 S/N on induction planes for pattern recognition and two-track separation.	ProtoDUNE and simulation
SP-FD-3	Light yield	> 20 PE/MeV (avg), > 0.5 PE/MeV (min)	Gives PDS energy resolution comparable to that of the TPC for 5-7 MeV SN vs, and allows tagging of > 99% of nucleon decay backgrounds with light at all points in detector.	Supernova and nucleon decay events in the FD with full simulation and reconstruction.
SP-FD-4	Time resolution	< 1 $\mu$ s (< 100 ns)	Enables 1 mm position resolution for 10 MeV SNB candidate events for instantaneous rate < 1 $m^{-3}ms^{-1}$ .	
SP-FD-5	Liquid argon purity	< 100 ppt (< 30 ppt)	Provides >5:1 S/N on induction planes for pattern recognition and two-track separation.	Purity monitors and cosmic ray tracks
SP-FD-6	Gaps between APAs	< 15 mm between APAs on same support beam; < 30 mm between APAs on different support beams	Maintains fiducial volume. Simplified construction.	ProtoDUNE
SP-FD-7	Drift field uniformity due to component alignment	< 1% throughout volume	Maintains APA, CPA, FC orientation and shape.	ProtoDUNE
SP-FD-8	APA wire angles	0° for collection wires, $\pm 35.7^\circ$ for induction wires	Minimize inter-APA dead space.	Engineering calculation
SP-FD-9	APA wire spacing	4.669 mm for U,V; 4.790 mm for X,G	Enables 100% efficient MIP detection, 1.5 cm yz vertex resolution.	Simulation
SP-FD-10	APA wire position tolerance	$\pm 0.5$ mm	Interplane electron transparency; $dE/dx$ , range, and MCS calibration.	ProtoDUNE and simulation

## Appendix A. Project document summary

SP-FD-11	Drift field uniformity due to HVS	$< 1\%$ throughout volume	High reconstruction efficiency.	ProtoDUNE and simulation
SP-FD-12	Cathode HV power supply ripple contribution to system noise	$< 100 e^-$	Maximize live time; maintain high S/N.	Engineering calculation, in situ measurement, ProtoDUNE
SP-FD-13	Front-end peaking time	$1 \mu s$	Vertex resolution; optimized for 5 mm wire spacing.	ProtoDUNE and simulation
SP-FD-14	Signal saturation level	$500,000 e^-$ (Adjustable so as to see saturation in less than 10% of beam-produced events)	Maintain calorimetric performance for multi-proton final state.	Simulation
SP-FD-15	LAr nitrogen contamination	$< 25$ ppm	Maintain 0.5 PE/MeV PDS sensitivity required for triggering proton decay near cathode.	In situ measurement
SP-FD-16	(downtime requirement replaced with 29 and 30)			
SP-FD-17	Cathode resistivity	$> 1 \text{ M}\Omega/\text{square}$ ( $> 1 \text{ G}\Omega/\text{square}$ )	Detector damage prevention.	ProtoDUNE
SP-FD-18	Cryogenic monitoring devices		Constrain uncertainties on detection efficiency, fiducial volume.	ProtoDUNE
SP-FD-19	ADC sampling frequency	$\sim 2 \text{ MHz}$	Match $1 \mu s$ shaping time.	Nyquist requirement and design choice
SP-FD-20	Number of ADC bits	12 bits	ADC noise contribution negligible (low end); match signal saturation specification (high end).	Engineering calculation and design choice
SP-FD-21	Cold electronics power consumption	$< 50 \text{ mW}/\text{channel}$	No bubbles in LAr to reduce HV discharge risk.	Bench test
SP-FD-22	Data rate to tape	$< 30 \text{ PB}/\text{year}$	Cost. Bandwidth.	ProtoDUNE
SP-FD-23	Supernova trigger	$> 95\%$ efficiency for a SNB producing at least 60 interactions with a neutrino energy $> 10 \text{ MeV}$ in 12 kt of active detector mass during the first 10 seconds of the burst.	$> 95\%$ efficiency for SNB within 20 kpc	Simulation and bench tests
SP-FD-24	Local electric fields	$< 30 \text{ kV}/\text{cm}$	Maximize live time; maintain high S/N.	ProtoDUNE
SP-FD-25	Non-FE noise contributions	$\ll 1000 e^-$	High S/N for high reconstruction efficiency.	Engineering calculation and ProtoDUNE

2020 JINST 15 T08009

## Appendix A. Project document summary

SP-FD-26	LAr impurity contributions from components	$\ll 30$ ppt	Maintain HV operating range for high live time fraction.	ProtoDUNE
SP-FD-27	Introduced radioactivity	less than that from $^{39}\text{Ar}$	Maintain low radiological backgrounds for SNB searches.	ProtoDUNE and assays during construction
SP-FD-28	Dead channels	$< 1\%$	Minimize the degradation in physics performance over the $> 20$ -year detector operation.	ProtoDUNE and bench tests
SP-FD-29	Detector uptime	$> 98\%$ ( $> 99\%$ )	Meet physics goals in timely fashion.	ProtoDUNE
SP-FD-30	Individual detector module uptime	$> 90\%$ ( $> 95\%$ )	Meet physics goals in timely fashion.	ProtoDUNE

**Table A.7:** APA specifications.

Label	Description	Specification (Goal)	Rationale	Validation
SP-FD-6	Gaps between APAs	$< 15$ mm between APAs on same support beam; $< 30$ mm between APAs on different support beams	Maintains fiducial volume. Simplified construction.	ProtoDUNE
SP-FD-7	Drift field uniformity due to component alignment	$< 1\%$ throughout volume	Maintains APA, CPA, FC orientation and shape.	ProtoDUNE
SP-FD-8	APA wire angles	$0^\circ$ for collection wires, $\pm 35.7^\circ$ for induction wires	Minimize inter-APA dead space.	Engineering calculation
SP-FD-9	APA wire spacing	4.669 mm for U,V; 4.790 mm for X,G	Enables 100% efficient MIP detection, 1.5 cm $yz$ vertex resolution.	Simulation
SP-FD-10	APA wire position tolerance	$\pm 0.5$ mm	Interplane electron transparency; $dE/dx$ , range, and MCS calibration.	ProtoDUNE and simulation
SP-APA-1	APA unit size	6.0 m tall $\times$ 2.3 m wide	Maximum size allowed for fabrication, transportation, and installation.	ProtoDUNE-SP
SP-APA-2	Active area	Maximize total active area.	Maximize area for data collection	ProtoDUNE-SP
SP-APA-3	Wire tension	$6\text{ N} \pm 1\text{ N}$	Prevent contact between wires and minimize break risk	ProtoDUNE-SP
SP-APA-4	Wire plane bias voltages	The setup, including boards, must hold 150% of max operating voltage.	Headroom in case adjustments needed	E-field simulation sets wire bias voltages. ProtoDUNE-SP confirms performance.

2020 JINST 15 T08009

## Appendix A. Project document summary

SP-APA-5	Frame planarity (twist limit)	<5 mm	APA transparency. Ensures wire plane spacing change of <0.5 mm.	ProtoDUNE-SP
SP-APA-6	Missing/unreadable channels	<1%, with a goal of <0.5%	Reconstruction efficiency	ProtoDUNE-SP

**Table A.8:** HV specifications.

Label	Description	Specification (Goal)	Rationale	Validation
SP-FD-1	Minimum drift field	> 250 V/cm (> 500 V/cm)	Lessens impacts of $e^-$ -Ar recombination, $e^-$ lifetime, $e^-$ diffusion and space charge.	ProtoDUNE
SP-FD-11	Drift field uniformity due to HVS	< 1% throughout volume	High reconstruction efficiency.	ProtoDUNE and simulation
SP-FD-12	Cathode HV power supply ripple contribution to system noise	< 100 $e^-$	Maximize live time; maintain high S/N.	Engineering calculation, in situ measurement, ProtoDUNE
SP-FD-17	Cathode resistivity	> 1 M $\Omega$ /square (> 1 G $\Omega$ /square)	Detector damage prevention.	ProtoDUNE
SP-FD-24	Local electric fields	< 30 kV/cm	Maximize live time; maintain high S/N.	ProtoDUNE
SP-FD-29	Detector uptime	> 98% (> 99%)	Meet physics goals in timely fashion.	ProtoDUNE
SP-FD-30	Individual detector module uptime	> 90% (> 95%)	Meet physics goals in timely fashion.	ProtoDUNE
SP-HV-1	Maximize power supply stability	> 95% uptime	Collect data over long period with high uptime.	ProtoDUNE
SP-HV-2	Provide redundancy in all HV connections.	Two-fold (Four-fold)	Avoid interrupting data collection or causing accesses to the interior of the detector.	Assembly QC

**Table A.9:** TPC electronics specifications.

Label	Description	Specification (Goal)	Rationale	Validation
SP-FD-2	System noise	< 1000 $e^-$	Provides >5:1 S/N on induction planes for pattern recognition and two-track separation.	ProtoDUNE and simulation
SP-FD-13	Front-end peaking time	1 $\mu$ s	Vertex resolution; optimized for 5 mm wire spacing.	ProtoDUNE and simulation

2020 JINST 15 T08009



## Appendix A. Project document summary

SP-FD-14	Signal saturation level	500,000 $e^-$ (Adjustable so as to see saturation in less than 10 % of beam-produced events)	Maintain calorimetric performance for multi-proton final state.	Simulation
SP-FD-19	ADC sampling frequency	$\sim 2$ MHz	Match 1 $\mu$ s shaping time.	Nyquist requirement and design choice
SP-FD-20	Number of ADC bits	12 bits	ADC noise contribution negligible (low end); match signal saturation specification (high end).	Engineering calculation and design choice
SP-FD-21	Cold electronics power consumption	$< 50$ mW/channel	No bubbles in LAr to reduce HV discharge risk.	Bench test
SP-FD-25	Non-FE noise contributions	$\ll 1000 e^-$	High S/N for high reconstruction efficiency.	Engineering calculation and ProtoDUNE
SP-FD-28	Dead channels	$< 1\%$	Minimize the degradation in physics performance over the $> 20$ -year detector operation.	ProtoDUNE and bench tests
SP-ELEC-1	Number of baselines in the front-end amplifier	2	Use a single type of amplifier for both induction and collection wires	ProtoDUNE
SP-ELEC-2	Gain of the front-end amplifier	$\sim 20$ mV/fC (Adjustable in the range 5 mV/fC to 25 mV/fC)	The gain of the FE amplifier is obtained from the maximum charge to be observed without saturation and from the operating voltage of the amplifier, that depends on the technology choice.	
SP-ELEC-3	System synchronization	50 ns (10 ns)	The dispersion of the sampling times on different wires of the APA should be much smaller than the sampling time (500 ns) and give a negligible contribution to the hit resolution.	
SP-ELEC-4	Number of channels per front-end motherboard	128	The total number of wires on one side of an APA, 1,280, must be an integer multiple of the number of channels on the FEMBs.	Design
SP-ELEC-5	Number of links between the FEMB and the WIB	4 at 1.28 Gbps (2 at 2.56 Gbps)	Balance between reducing the number of links and reliability and power issues when increasing the data transmission speed.	ProtoDUNE, Laboratory measurements on bit error rates

2020 JINST 15 T08009

## Appendix A. Project document summary

SP-ELEC-6	Number of FEMBs per WIB	4	The total number of FEMB per WIB is a balance between the complexity of the boards, the mechanics inside the WIEC, and the required processing power of the FPGA on the WIB.	ProtoDUNE, Design
SP-ELEC-7	Data transmission speed between the WIB and the DAQ backend	10 Gbps	Balance between cost and reduction of the number of optical fiber links for each WIB.	ProtoDUNE, Laboratory measurements on bit error rates
SP-ELEC-8	Maximum diameter of conduit enclosing the cold cables while they are routed through the APA frame	6.35 cm (2.5")	Avoid the need for further changes to the APA frame and for routing the cables along the cryostat walls	Tests on APA frame prototypes

**Table A.10:** PDS specifications.

Label	Description	Specification (Goal)	Rationale	Validation
SP-FD-3	Light yield	$> 20$ PE/MeV (avg), $> 0.5$ PE/MeV (min)	Gives PDS energy resolution comparable to that of the TPC for 5-7 MeV SN vs, and allows tagging of $> 99\%$ of nucleon decay backgrounds with light at all points in detector.	Supernova and nucleon decay events in the FD with full simulation and reconstruction.
SP-FD-4	Time resolution	$< 1 \mu\text{s}$ ( $< 100$ ns)	Enables 1 mm position resolution for 10 MeV SNB candidate events for instantaneous rate $< 1 \text{ m}^{-3} \text{ ms}^{-1}$ .	
SP-FD-15	LAr nitrogen contamination	$< 25$ ppm	Maintain 0.5 PE/MeV PDS sensitivity required for triggering proton decay near cathode.	In situ measurement
SP-PDS-1	Clean assembly area	Class 100,000 clean assembly area	Demonstrated as satisfactory in ProtoDUNE-SP, and is the DUNE assembly area standard.	ProtoDUNE-SP and in Fermilab materials test stand
SP-PDS-2	Spatial localization in y-z plane	$< 2.5$ m	Enables accurate matching of PD and TPC signals.	SNB neutrino and NDK simulation in the FD
SP-PDS-3	Environmental light exposure	No exposure to sunlight. All other unfiltered sources: $< 30$ minutes integrated across all exposures	Shown to prevent damage to WLS coatings due to UV.	Studies in ProtoDUNE-SP, and at IU

2020 JINST 15 T08009

## Appendix A. Project document summary

SP-PDS-4	Environmental humidity limit	< 50 % RH at 70 °F	Demonstrated to prevent damage to WLS coatings due to humidity.	PD optical coating studies
SP-PDS-5	Light-tight cryostat	Cryostat light leaks responsible for < 10 % of data transferred from PDS to DAQ	Minimizing false triggers due to cryostat light leaks helps limit the data transfer rate to DAQ.	ProtoDUNE-SP and ICEBERG
SP-PDS-7	Mechanical deflection (static)	< 5 mm	Minimize motion of PD modules inside the APA (due to static and dynamic loads) to avoid damaging APA.	PD FEA, ProtoDUNE-SP, ICEBERG; Ash River integration tests and CERN pre-production integration tests pending
SP-PDS-8	Clearance for installation through APA side tubes	> 1 mm	Maintain required clearance to allow PD insertion into APA following wire wrapping.	PD FEA, ProtoDUNE-SP, ICEBERG; Ash River integration tests and CERN pre-production integration tests pending
SP-PDS-9	No mechanical interference with APA, SP-CE and SP-HV detector elements (clearance)	> 1 mm	PD mounting and securing element tolerances must prevent interference with APA and CE cable bundles.	ICEBERG, Ash River integration tests, and the CERN pre-production integration tests
SP-PDS-10	APA intrusion limit for PD cable routing	< 6 mm	PD modules must install into APA frames following wire wrapping. PD modules must not occlude APA side tubes.	ICEBERG, Ash River integration tests, and the CERN pre-production integration tests
SP-PDS-11	PD cabling cannot limit upper-lower APA junction gap	0 mm separation mechanically allowed	PD cable connections must not limit the minimum upper and lower APA separation.	ICEBERG, Ash River integration tests, and the CERN pre-production integration tests
SP-PDS-12	Maintain PD-APA clearance at LAr temperature	> 0.5 mm	PD mounting frame and cable harness must accommodate thermal contraction of itself and APA frame.	Thermal modeling, ProtoDUNE, ICEBERG, CERN pre-production integration tests

2020 JINST 15 T08009

## Appendix A. Project document summary

SP-PDS-13	Data transfer rate from SP-PD to DAQ	< 8 Gbps	PD data transfer must not exceed DAQ data throughput capability.	Maximum bandwidth out of the PD electronics is 80 Mbps
SP-PDS-14	Signal-to-noise in SP-PD	> 4	Keep data rate within electronics bandwidth limits.	ProtoDUNE-SP, ICEBERG and ProtoDUNE-SP-2
SP-PDS-15	Dark noise rate in SP-PD	< 1 kHz	Keep data rate within electronics bandwidth limits.	Pre-production photosensor testing, ProtoDUNE-SP, ICEBERG and ProtoDUNE-SP-2
SP-PDS-16	Dynamic Range in SP-PD	< 20 %	Keep the rate of saturating channels low enough for effective mitigation.	Pre-production photosensor testing, ProtoDUNE-SP, ICEBERG and ProtoDUNE-SP-2

**Table A.11:** Calibration specifications.

Label	Description	Specification (Goal)	Rationale	Validation
SP-FD-1	Minimum drift field	> 250 V/cm (> 500 V/cm)	Lessens impacts of $e^-$ -Ar recombination, $e^-$ lifetime, $e^-$ diffusion and space charge.	ProtoDUNE
SP-FD-2	System noise	< 1000 $e^-$	Provides >5:1 S/N on induction planes for pattern recognition and two-track separation.	ProtoDUNE and simulation
SP-FD-5	Liquid argon purity	< 100 ppt (< 30 ppt)	Provides >5:1 S/N on induction planes for pattern recognition and two-track separation.	Purity monitors and cosmic ray tracks
SP-FD-7	Drift field uniformity due to component alignment	< 1 % throughout volume	Maintains APA, CPA, FC orientation and shape.	ProtoDUNE
SP-FD-9	APA wire spacing	4.669 mm for U,V; 4.790 mm for X,G	Enables 100% efficient MIP detection, 1.5 cm $y_z$ vertex resolution.	Simulation
SP-FD-11	Drift field uniformity due to HVS	< 1 % throughout volume	High reconstruction efficiency.	ProtoDUNE and simulation
SP-FD-13	Front-end peaking time	1 $\mu$ s	Vertex resolution; optimized for 5 mm wire spacing.	ProtoDUNE and simulation
SP-FD-22	Data rate to tape	< 30 PB/year	Cost. Bandwidth.	ProtoDUNE

2020 JINST 15 T08009

## Appendix A. Project document summary

SP-FD-23	Supernova trigger	> 95 % efficiency for a SNB producing at least 60 interactions with a neutrino energy >10 MeV in 12 kt of active detector mass during the first 10 seconds of the burst.	> 95% efficiency for SNB within 20 kpc	Simulation and bench tests
SP-FD-24	Local electric fields	< 30 kV/cm	Maximize live time; maintain high S/N.	ProtoDUNE
SP-FD-25	Non-FE noise contributions	<< 1000 $e^-$	High S/N for high reconstruction efficiency.	Engineering calculation and ProtoDUNE
SP-FD-26	LAr impurity contributions from components	<< 30 ppt	Maintain HV operating range for high live time fraction.	ProtoDUNE
SP-FD-27	Introduced radioactivity	less than that from $^{39}\text{Ar}$	Maintain low radiological backgrounds for SNB searches.	ProtoDUNE and assays during construction
SP-FD-29	Detector uptime	> 98% (> 99%)	Meet physics goals in timely fashion.	ProtoDUNE
SP-FD-30	Individual detector module uptime	> 90% (> 95%)	Meet physics goals in timely fashion.	ProtoDUNE
SP-CALIB-1	Ionization laser E field measurement precision	1 %	E field affects energy and position measurements.	ProtoDUNE and external experiments.
SP-CALIB-2	Ionization laser E field measurement coverage	> 75 % (100 %)	Allowable size of the uncovered detector regions is set by the highest reasonably expected field distortions, 4 %.	ProtoDUNE
SP-CALIB-3	Ionization laser E field measurement granularity	$30 \times 30 \times 30 \text{ cm}^3$ ( $10 \times 10 \times 10 \text{ cm}^3$ )	Minimum measurable region is set by the maximum expected distortion and position reconstruction requirements.	ProtoDUNE
SP-CALIB-4	Laser beam location precision	0.5 mrad (< 0.5 mrad)	The necessary spatial precision does not need to be smaller than the APA wire gap.	ProtoDUNE
SP-CALIB-5	Neutron source coverage	> 75 % (100 %)	Set by the energy resolution requirements at low energy.	Simulations
SP-CALIB-6	Ionization laser data volume per year (per 10 kt)	> 184 TB/yr/10kt (> 368 TB/yr/10kt)	The laser data volume must allow the needed coverage and granularity.	ProtoDUNE and simulations
SP-CALIB-7	Neutron source data volume per year (per 10 kt)	> 144 TB/yr/10kt (> 288 TB/yr/10kt)	The pulsed neutron system must allow the needed coverage and granularity.	Simulations

2020 JINST 15 T08009

Table A.12: DAQ specifications.

Label	Description	Specification (Goal)	Rationale	Validation
SP-FD-22	Data rate to tape	< 30 PB/year	Cost. Bandwidth.	ProtoDUNE
SP-FD-23	Supernova trigger	> 95 % efficiency for a SNB producing at least 60 interactions with a neutrino energy >10 MeV in 12 kt of active detector mass during the first 10 seconds of the burst.	> 95% efficiency for SNB within 20 kpc	Simulation and bench tests
SP-DAQ-1	DAQ readout throughput: The DAQ shall be able to accept the continuous data stream from the TPC and Photon detectors.	1.5 TB/s per single phase detector module	Specification from TPC and PDS electronics	Modular test on ProtoDUNE; overall throughput scales linearly with number of APAs
SP-DAQ-2	DAQ storage throughput: The DAQ shall be able to store selected data at an average throughput of 10 Gb/s, with temporary peak throughput of 100 Gb/s.	10 Gb/s average storage throughput; 100 Gb/s peak temporary storage throughput per single phase detector module	Average throughput estimated from physics and calibration requirements; peak throughput allowing for fast storage of SNB data ( $\sim 10^4$ seconds to store 120 TB of data).	ProtoDUNE demonstrated steady storage at $\sim 40$ Gb/s for a storage volume of 700 TB. Laboratory tests will allow to demonstrate the performance reach.
SP-DAQ-3	DAQ readout window: The DAQ shall support storing triggered data of one or more APAs with a variable size readout window, from few $\mu$ s (calibration) to 100 s (SNB), with a typical readout window for triggered interactions of 5.4 ms.	$10 \mu$ s < readout window < 100 s	Storage of the complete dataset for up to 100 s is required by the SNB physics studies; the typical readout window of 5.4 ms is defined by the drift time in the detector; calibration triggers can be configured to readout data much shorter time intervals.	Implementation techniques to be validated on the ProtoDUNE setup and in test labs.

Appendix A. Project document summary

<p>SP-DAQ-4</p>	<p>Calibration trigger: The DAQ shall provide the means to distribute time-synchronous commands to the calibration systems, in order to fire them, at a configurable rate and sequence and at configurable intervals in time. Those commands may be distributed during physics data taking or during special calibration data taking sessions. The DAQ shall trigger and acquire data at a fixed, configurable interval after the distribution of the commands, in order to capture the response of the detector to calibration stimuli.</p>	<p>Calibration is essential to attain required detector performance comprehension.</p>	<p>Techniques for doing this have been run successfully in MicroBooNE and ProtoDUNE.</p>
<p>SP-DAQ-5</p>	<p>Data record: Corresponding to every trigger, the DAQ shall form a data record to be transferred to offline together with the metadata necessary for validation and processing.</p>	<p>Needed for offline analysis.</p>	<p>Common experimental practice.</p>
<p>SP-DAQ-6</p>	<p>Data verification: The DAQ shall check integrity of data at every data transfer step. It shall only delete data from the local storage after confirmation that data have been correctly recorded to permanent storage.</p>	<p>Data integrity checking is fundamental to ensure data quality.</p>	

2020 JINST 15 T08009

## Appendix A. Project document summary

SP-DAQ-7	High-energy Trigger: The DAQ shall trigger and acquire data on visible energy deposition >100 MeV. Data acquisition may be limited to the area in which activity was detected.	>100 MeV	Driven by DUNE physics mission.	Physics TDR. 100 MeV is an achievable parameter; lower thresholds are possible.
SP-DAQ-8	Low-energy Trigger: The DAQ shall trigger and acquire data on visible energy deposition > 10 MeV of single neutrino interactions. Those triggers will normally be fired using a pre-scaling factor, in order to limit the data volume.	>10 MeV	Driven by DUNE physics mission.	Physics TDR. 10 MeV is an achievable parameter; lower thresholds are possible.
SP-DAQ-9	DAQ deadtime: While taking data within the agreed conditions, the DAQ shall be able to trigger and acquire data without introducing any deadtime.		Driven by DUNE physics mission.	Zero deadtime is an achievable inter-event deadtime but a small deadtime would not significantly compromise physics sensitivity.

**Table A.13:** CISC specifications.

Label	Description	Specification (Goal)	Rationale	Validation
SP-FD-5	Liquid argon purity	< 100 ppt (< 30 ppt)	Provides >5:1 S/N on induction planes for pattern recognition and two-track separation.	Purity monitors and cosmic ray tracks
SP-FD-15	LAr nitrogen contamination	< 25 ppm	Maintain 0.5 PE/MeV PDS sensitivity required for triggering proton decay near cathode.	In situ measurement
SP-FD-18	Cryogenic monitoring devices		Constrain uncertainties on detection efficiency, fiducial volume.	ProtoDUNE
SP-FD-25	Non-FE noise contributions	$\ll 1000 e^-$	High S/N for high reconstruction efficiency.	Engineering calculation and ProtoDUNE



## Appendix A. Project document summary

SP-FD-29	Detector uptime	> 98% (> 99%)	Meet physics goals in timely fashion.	ProtoDUNE
SP-FD-30	Individual detector module uptime	> 90% (> 95%)	Meet physics goals in timely fashion.	ProtoDUNE
SP-CISC-1	Noise from Instrumentation devices	$\ll 1000 e^-$	Max noise for 5:1 S/N for a MIP passing near cathode; per SBND and DUNE CE	ProtoDUNE
SP-CISC-2	Max. E field near instrumentation devices	< 30 kV/cm (< 15 kV/cm)	Significantly lower than max field of 30 kV/cm per DUNE HV	3D electrostatic simulation
SP-CISC-3	Precision in electron lifetime	< 1.4% (< 1%)	Required for accurate charge reconstruction per DUNE-FD Task Force report.	ProtoDUNE-SP and CITF
SP-CISC-4	Range in electron lifetime	0.04 ms to 10 ms in cryostat, 0.04 ms to 30 ms inline	Slightly beyond best values observed so far in other detectors.	ProtoDUNE-SP and CITF
SP-CISC-11	Precision: temperature reproducibility	< 5 mK (2 mK)	Enables validation of CFD models, which predicts gradients below 15 mK	ProtoDUNE-SP and CITF
SP-CISC-14	Temperature stability	< 2 mK at all places and times (Match precision requirement at all places, at all times)	Measure the temp map with sufficient precision during the entire duration	ProtoDUNE-SP
SP-CISC-27	Cold camera coverage	> 80% of HV surfaces (100%)	Enable detailed inspection of issues near HV surfaces.	Calculated from location, validated in prototypes.
SP-CISC-51	Slow control alarm rate	< 150/day (< 50/day)	Alarm rate low enough to allow response to every alarm.	Detector module; depends on experimental conditions
SP-CISC-52	Total No. of variables	> 150,000 (150,000 to 200,000)	Scaled from ProtoDUNE-SP	ProtoDUNE-SP and CITF
SP-CISC-54	Archiving rate	0.02 Hz (Broad range 1 Hz to 1 per few min.)	Archiving rate different for each variable, optimized to store important information	ProtoDUNE-SP

**Table A.14:** Installation specifications.

Label	Description	Specification (Goal)	Rationale	Validation
SP-INST-1	Compliance with the SURF Material Handling Specification for all material transported underground	SURF Material Handling Specification	Loads must fit in the shaft be lifted safely.	Visual and documentation check

## Appendix A. Project document summary

SP-INST-2	Coordination of shipments with CMGC; DUNE to schedule use of Ross Shaft	2 wk notice to CMGC	Both DUNE and CMGC need to use Ross Shaft	Deliveries will be rejected
SP-INST-3	Maintain materials buffer at logistics facility in SD	> 1 month	Prevent schedule delays in case of shipping or customs delays	Documentatation and progress reporting
SP-INST-4	APA stroage at logistics facility in SD	700 m <sup>2</sup>	Store APAs during lag between production and installation	Agree upon space needs
SP-INST-5	Installation cleanroom Specificaiton	ISO 8	Reduce dust (contains U/Th) to prevent induced radiological background in detector	Monitor air purity
SP-INST-6	UV filter in installation cleanrooms for PDS sensor protection	filter < 400 nm for > 2 wk exp; < 520 nm all else	Prevent damage to PD coatings	Visual or spectrographic inspection

### A.4.2 Dual-phase

**Table A.15:** Specifications for DP-FD.

Label	Description	Specification (Goal)	Rationale	Validation
DP-FD-1	Minimum drift field	> 250 V/cm (> 500 V/cm)	Reduces impacts of $e^-$ -Ar recombination, $e^-$ lifetime, $e^-$ diffusion and space charge.	ProtoDUNE
DP-FD-2	System noise	< 1000 $e^-$	Studies suggest that a minimum of 5:1 S/N on individual strip measurements allows for sufficient reconstruction performance.	ProtoDUNE and simulation
DP-FD-3	Light yield	> 1 PE/MeV (at anode), > 5 PE/MeV (avg over active volume)	Enable drift position determination of NDK candidates. Enable PD system-based triggering on galactic SNBs.	Full sim/reco of NDK, SNB $\nu$ and radiological events.
DP-FD-4	Time resolution	< 1 $\mu$ s (< 100 ns)	Enables 1 mm position resolution for 10 MeV SNB candidate events for instantaneous rate < 1 m <sup>-3</sup> ms <sup>-1</sup> .	

2020 JINST 15 T08009

Appendix A. Project document summary

DP-FD-5	Liquid argon purity	> 5 ms	Directly impacts the number of electrons received at the CRP collection strips and hence the S/N.	Purity monitors and cosmic ray tracks
DP-FD-6	Gaps between CRPs	< 30 mm between adjacent CRPs	Required for CRP positioning and shrinkage. Simplified construction.	ProtoDUNE
DP-FD-7	Drift field uniformity due to component alignment	< 1% throughout volume	Maintains TPC and FC orientation and shape.	ProtoDUNE
DP-FD-8	CRP effective gain	6	Yields S/N of 20 for 6 m drift and 34.6 for 3 m (for E 250 V/cm and 5 ms e lifetime). For 7 ms electron lifetime yields S/N of 12.5 for 12 m drift, 27.3 for 6 m, and 40.5 for 3 m.	
DP-FD-9	CRP strips spacing	< 4.7 mm	Enables 100% efficient MIP detection, 1.5 cm yz vertex resolution.	Simulation
DP-FD-10	CRP planarity	$\pm 0.5$ mm	Guarantee the uniformity of the extraction field and the immersion of the extraction grid.	ProtoDUNE and simulation
DP-FD-11	Drift field uniformity due to HVS	< 1% throughout volume	High reconstruction efficiency.	ProtoDUNE and simulation
DP-FD-12	Cathode HV power supply ripple contribution to system noise	< 100 e <sup>-</sup>	Maximize live time; maintain high S/N.	Engineering calculation, in situ measurement, ProtoDUNE
DP-FD-13	Front-end peaking time	1 $\mu$ s (1 $\mu$ s achieved in current design)	Vertex resolution; 1 $\mu$ s matches 3mm pitch and DP S/N ratio.	ProtoDUNE and simulation
DP-FD-14	Signal saturation level	7,500,000 electrons	Maintain calorimetric performance for multi-proton final state; takes into account an effective CRP gain of 20 in the DP signal dynamics.	Simulation
DP-FD-15	LAr nitrogen contamination	< 3 ppm	Higher contaminations significantly affect the no. of photons that reach the PMT.	In situ measurement
DP-FD-16	(downtime requirement replaced with 29 and 30)			

2020 JINST 15 T08009

Appendix A. Project document summary

DP-FD-17	Cathode resistivity	> 1 M $\Omega$ /square (> 1 G $\Omega$ /square)	Detector damage prevention.	ProtoDUNE
DP-FD-18	Cryogenic monitoring devices		Constrain uncertainties on detection efficiency, fiducial volume.	ProtoDUNE
DP-FD-19	ADC sampling frequency	$\sim$ 2.5 MHz	Match 1 $\mu$ s shaping time.	Nyquist requirement and design choice
DP-FD-20	Number of ADC bits	12 bits	ADC noise contribution negligible (low end); match signal saturation specification (high end).	Engineering calculation and design choice
DP-FD-21	TPC analog cold FE electronics power consumption	< 50 mW/channel	No bubbles in LAr to reduce HV discharge risk.	Bench test
DP-FD-22	Data rate to tape	< 30 PB/year	Cost. Bandwidth.	ProtoDUNE
DP-FD-23	Supernova trigger	> 95 % efficiency for a SNB producing at least 60 interactions with a neutrino energy >10 MeV in 12 kt of active detector mass during the first 10 seconds of the burst.	> 95% efficiency for SNB within 100 kpc	Simulation and bench tests
DP-FD-24	Local electric fields	< 30 kV/cm	Maximize live time; maintain high S/N.	ProtoDUNE
DP-FD-25	Non-FE noise contributions	$\ll$ 1000 $e^-$	High S/N for high reconstruction efficiency.	Engineering calculation and ProtoDUNE
DP-FD-26	LAr impurity contributions from components	$\ll$ 30 ppt		ProtoDUNE
DP-FD-27	Introduced radioactivity	less than that from $^{39}\text{Ar}$	Maintain low radiological backgrounds for SNB searches.	ProtoDUNE and assays during construction
DP-FD-28	Dead channels	< 1 %	Contingency for possible efficiency loss for > 20 year operation. All DP electronics are accessible.	ProtoDUNE
DP-FD-29	Detector uptime	> 98% (> 99%)	Meet physics goals in timely fashion.	ProtoDUNE
DP-FD-30	Individual detector module uptime	> 90% (> 95%)	Meet physics goals in timely fashion.	ProtoDUNE

2020 JINST 15 T08009

Table A.16: DP CRP specifications.

Label	Description	Specification (Goal)	Rationale	Validation
DP-FD-1	Minimum drift field	$> 250$ V/cm ( $> 500$ V/cm)	Reduces impacts of $e^-$ -Ar recombination, $e^-$ lifetime, $e^-$ diffusion and space charge.	ProtoDUNE
DP-FD-2	System noise	$< 1000 e^-$	Studies suggest that a minimum of 5:1 S/N on individual strip measurements allows for sufficient reconstruction performance.	ProtoDUNE and simulation
DP-FD-3	Light yield	$> 1$ PE/MeV (at anode), $> 5$ PE/MeV (avg over active volume)	Enable drift position determination of NDK candidates. Enable PD system-based triggering on galactic SNBs.	Full sim/reco of NDK, SNB $\nu$ and radiological events.
DP-FD-4	Time resolution	$< 1 \mu\text{s}$ ( $< 100$ ns)	Enables 1 mm position resolution for 10 MeV SNB candidate events for instantaneous rate $< 1 \text{ m}^{-3}\text{ms}^{-1}$ .	
DP-FD-5	Liquid argon purity	$> 5$ ms	Directly impacts the number of electrons received at the CRP collection strips and hence the S/N.	Purity monitors and cosmic ray tracks
DP-FD-6	Gaps between CRPs	$< 30$ mm between adjacent CRPs	Required for CRP positioning and shrinkage. Simplified construction.	ProtoDUNE
DP-FD-8	CRP effective gain	6	Yields S/N of 20 for 6 m drift and 34.6 for 3 m (for E 250 V/cm and 5 ms $e^-$ lifetime). For 7 ms electron lifetime yields S/N of 12.5 for 12 m drift, 27.3 for 6 m, and 40.5 for 3 m.	
DP-FD-9	CRP strips spacing	$< 4.7$ mm	Enables 100% efficient MIP detection, 1.5 cm $yz$ vertex resolution.	Simulation
DP-FD-10	CRP planarity	$\pm 0.5$ mm	Guarantee the uniformity of the extraction field and the immersion of the extraction grid.	ProtoDUNE and simulation
DP-CRP-1	CRP vertical positioning precision	$< 1$ mm	The extraction grid must remain below the liquid argon surface	Obtained by design

**Table A.17:** DP HV specifications.

Label	Description	Specification (Goal)	Rationale	Validation
DP-FD-1	Minimum drift field	$> 250$ V/cm ( $> 500$ V/cm)	Reduces impacts of $e^-$ -Ar recombination, $e^-$ lifetime, $e^-$ diffusion and space charge.	ProtoDUNE
DP-FD-11	Drift field uniformity due to HVS	$< 1\%$ throughout volume	High reconstruction efficiency.	ProtoDUNE and simulation
DP-FD-12	Cathode HV power supply ripple contribution to system noise	$< 100 e^-$	Maximize live time; maintain high S/N.	Engineering calculation, in situ measurement, ProtoDUNE
DP-FD-17	Cathode resistivity	$> 1$ M $\Omega$ /square ( $> 1$ G $\Omega$ /square)	Detector damage prevention.	ProtoDUNE
DP-FD-24	Local electric fields	$< 30$ kV/cm	Maximize live time; maintain high S/N.	ProtoDUNE
DP-HV-1	Provide redundancy in HV distribution	$> 2$ HVDB chain (12 HVDB chains)	Ensure the HV connections to the detector	ProtoDUNE and calculations

**Table A.18:** DP TPC electronics specifications.

Label	Description	Specification (Goal)	Rationale	Validation
DP-FD-2	System noise	$< 1000 e^-$	Studies suggest that a minimum of 5:1 S/N on individual strip measurements allows for sufficient reconstruction performance.	ProtoDUNE and simulation
DP-FD-4	Time resolution	$< 1 \mu\text{s}$ ( $< 100$ ns)	Enables 1 mm position resolution for 10 MeV SNB candidate events for instantaneous rate $< 1 \text{ m}^{-3} \text{ ms}^{-1}$ .	
DP-FD-13	Front-end peaking time	$1 \mu\text{s}$ ( $1 \mu\text{s}$ achieved in current design)	Vertex resolution; 1 $\mu\text{s}$ matches 3mm pitch and DP S/N ratio.	ProtoDUNE and simulation
DP-FD-14	Signal saturation level	7,500,000 electrons	Maintain calorimetric performance for multi-proton final state; takes into account an effective CRP gain of 20 in the DP signal dynamics.	Simulation
DP-FD-19	ADC sampling frequency	$\sim 2.5$ MHz	Match $1 \mu\text{s}$ shaping time.	Nyquist requirement and design choice

## Appendix A. Project document summary

DP-FD-20	Number of ADC bits	12 bits	ADC noise contribution negligible (low end); match signal saturation specification (high end).	Engineering calculation and design choice
DP-FD-21	TPC analog cold FE electronics power consumption	< 50 mW/channel	No bubbles in LAr to reduce HV discharge risk.	Bench test

**Table A.19:** DP PDS specifications.

Label	Description	Specification (Goal)	Rationale	Validation
DP-FD-3	Light yield	> 1 PE/MeV (at anode), > 5 PE/MeV (avg over active volume)	Enable drift position determination of NDK candidates. Enable PD system-based triggering on galactic SNBs.	Full sim/reco of NDK, SNB $\nu$ and radiological events.
DP-FD-4	Time resolution	< 1 $\mu$ s (< 100 ns)	Enables 1 mm position resolution for 10 MeV SNB candidate events for instantaneous rate < 1 m <sup>-3</sup> ms <sup>-1</sup> .	
DP-FD-15	LAr nitrogen contamination	< 3 ppm	Higher contaminations significantly affect the no. of photons that reach the PMT.	In situ measurement
DP-PDS-1	Relative timing accuracy among hits	< 100 nsRMS	Enable effective clustering of PMT signals based on relative hit timing information.	Full sim/reco of NDK, SNB $\nu$ and radiological events.
DP-PDS-2	Hit signal-to-noise ratio	> 5	Efficiently reconstruct single-photoelectron hits while rate of electronics noise hits remains manageable.	Single-photoelectron and baseline noise RMS measurements in 3 $\times$ 1 $\times$ 1 prototype.
DP-PDS-3	PMT dark count rate	< 100 kHz	Avoid effects on clustering algorithm and PD system-based calorimetry.	Characterization of PMTs at cryo temps prior to installation.
DP-PDS-4	Analog range per channel	> 100 PE/(ch $\times$ 6ns)	Minimize hit saturation for scintillation-based calorimetry over 6 ns prompt light period, esp. for beam events.	Full sim/reco of beam $\nu$ interactions.

2020 JINST 15 T08009

**Table A.20:** DP calibration specifications.

Label	Description	Specification (Goal)	Rationale	Validation
DP-FD-1	Minimum drift field	> 250 V/cm (> 500 V/cm)	Reduces impacts of $e^-$ -Ar recombination, $e^-$ lifetime, $e^-$ diffusion and space charge.	ProtoDUNE
DP-FD-2	System noise	< 1000 $e^-$	Studies suggest that a minimum of 5:1 S/N on individual strip measurements allows for sufficient reconstruction performance.	ProtoDUNE and simulation
DP-FD-5	Liquid argon purity	> 5 ms	Directly impacts the number of electrons received at the CRP collection strips and hence the S/N.	Purity monitors and cosmic ray tracks
DP-FD-7	Drift field uniformity due to component alignment	< 1% throughout volume	Maintains TPC and FC orientation and shape.	ProtoDUNE
DP-FD-9	CRP strips spacing	< 4.7 mm	Enables 100% efficient MIP detection, 1.5 cm yz vertex resolution.	Simulation
DP-FD-11	Drift field uniformity due to HVS	< 1% throughout volume	High reconstruction efficiency.	ProtoDUNE and simulation
DP-FD-13	Front-end peaking time	1 $\mu$ s (1 $\mu$ s achieved in current design)	Vertex resolution; 1 $\mu$ s matches 3mm pitch and DP S/N ratio.	ProtoDUNE and simulation
DP-FD-22	Data rate to tape	< 30 PB/year	Cost. Bandwidth.	ProtoDUNE
DP-FD-23	Supernova trigger	> 95% efficiency for a SNB producing at least 60 interactions with a neutrino energy >10 MeV in 12 kt of active detector mass during the first 10 seconds of the burst.	> 95% efficiency for SNB within 100 kpc	Simulation and bench tests
DP-FD-24	Local electric fields	< 30 kV/cm	Maximize live time; maintain high S/N.	ProtoDUNE
DP-FD-25	Non-FE noise contributions	$\ll$ 1000 $e^-$	High S/N for high reconstruction efficiency.	Engineering calculation and ProtoDUNE
DP-FD-26	LAr impurity contributions from components	$\ll$ 30 ppt		ProtoDUNE



## Appendix A. Project document summary

DP-FD-27	Introduced radioactivity	less than that from $^{39}\text{Ar}$	Maintain low radiological backgrounds for SNB searches.	ProtoDUNE and assays during construction
DP-FD-29	Detector uptime	> 98% (> 99%)	Meet physics goals in timely fashion.	ProtoDUNE
DP-FD-30	Individual detector module uptime	> 90% (> 95%)	Meet physics goals in timely fashion.	ProtoDUNE
DP-CALIB-1	Ionization laser E field measurement precision	1 %	E field affects energy and position measurements.	ProtoDUNE and external experiments.
DP-CALIB-2	Ionization laser E field measurement coverage	> 93 % (100 %)	Allowable size of the uncovered detector regions is set by the highest reasonably expected field distortions, 15 %.	ProtoDUNE
DP-CALIB-3	Ionization laser E field measurement granularity	10 cm × 10 cm × 10 cm (10 cm × 10 cm × 10 cm)	Minimum measurable region is set by the maximum expected distortion and position reconstruction requirements.	ProtoDUNE
DP-CALIB-4	Laser beam position precision	0.5 mrad (< 0.5 mrad)	The necessary spatial precision does not need to be smaller than the CRP strip spacing.	ProtoDUNE
DP-CALIB-5	Neutron source coverage	> 75 % (100 %)	Set by the energy resolution requirements at low energy.	Simulations
DP-CALIB-6	Ionization laser DAQ rate per year (per 10 kt)	> 37 TB/yr/10kt (> 74 TB/yr/10kt)	The laser data volume must allow the needed coverage and granularity.	ProtoDUNE and simulations
DP-CALIB-7	Neutron source DAQ rate per year (per 10 kt)	> 170 TB/yr/10kt (> 340 TB/yr/10kt)	The pulsed neutron system must allow the needed coverage and granularity.	Simulations

2020 JINST 15 T08009

**Table A.21:** DP DAQ specifications.

Label	Description	Specification (Goal)	Rationale	Validation
DP-FD-22	Data rate to tape	< 30 PB/year	Cost. Bandwidth.	ProtoDUNE
DP-FD-23	Supernova trigger	> 95 % efficiency for a SNB producing at least 60 interactions with a neutrino energy >10 MeV in 12 kt of active detector mass during the first 10 seconds of the burst.	> 95% efficiency for SNB within 100 kpc	Simulation and bench tests
DP-DAQ-1	DAQ readout throughput: The DAQ shall be able to accept the continuous, compressed data stream from the TPC and Photon detectors.	65 GB/s per dual phase detector module	Specification from TPC and PDS electronics	Modular test on test bench; overall throughput scales linearly with the number of electronics crates.
DP-DAQ-2	DAQ storage throughput: The DAQ shall be able to store selected data at an average throughput of 2 Gb/s, with temporary peak throughput of 100 Gb/s.	2 GB/s average storage throughput; 100 GB/s peak temporary storage throughput per dual phase detector module	Average throughput estimated from physics and calibration requirements; peak throughput allowing for fast storage of SNB data.	ProtoDUNE demonstrated steady storage at ~ 40 Gb/s for a storage volume of 700 TB. Laboratory tests will allow to demonstrate the performance reach.
DP-DAQ-3	DAQ readout window: The DAQ shall support storing triggered data of one or more CRPs with a variable size readout window, from few $\mu$ s (calibration) to 100 s (SNB), with a typical readout window for triggered interactions of 7.5 ms.	10 $\mu$ s < readout window < 100 s	Storage of the complete dataset for up to 100 s is required by the SNB physics studies; the typical readout window of 7.5 ms is defined by the drift time in the detector; calibration triggers can be configured to readout data much shorter time intervals.	Implementation techniques to be validated on the ProtoDUNE setup and in test labs.

2020 JINST 15 T08009

Appendix A. Project document summary

DP-DAQ-4	<p>Calibration trigger: The DAQ shall provide the means to distribute time-synchronous commands to the calibration systems, in order to fire them, at a configurable rate and sequence and at configurable intervals in time. Those commands may be distributed during physics data taking or during special calibration data taking sessions. The DAQ shall trigger and acquire data at a fixed, configurable interval after the distribution of the commands, in order to capture the response of the detector to calibration stimuli.</p>	<p>Calibration is essential to attain required detector performance comprehension.</p>	<p>Techniques for doing this have been run successfully in MicroBooNE and ProtoDUNE.</p>
DP-DAQ-5	<p>Data record: Corresponding to every trigger, the DAQ shall form a data record to be transferred to offline together with the metadata necessary for validation and processing.</p>	<p>Needed for offline analysis.</p>	<p>Common experimental practice.</p>
DP-DAQ-6	<p>Data verification: The DAQ shall check integrity of data at every data transfer step. It shall only delete data from the local storage after confirmation that data have been correctly recorded to permanent storage.</p>	<p>Data integrity checking is fundamental to ensure data quality.</p>	

2020 JINST 15 T08009

## Appendix A. Project document summary

DP-DAQ-7	High-energy Trigger: > 100 MeV The DAQ shall trigger and acquire data on visible energy deposition > 100 MeV. Data acquisition may be limited to the area in which activity was detected.	Driven by DUNE physics mission.	Physics TDR. 100 MeV is an achievable parameter; lower thresholds are possible.
DP-DAQ-8	Low-energy Trigger: > 10 MeV The DAQ shall trigger and acquire data on visible energy deposition > 10 MeV of single neutrino interactions. Those triggers will normally be fired using a pre-scaling factor, in order to limit the data volume.	Driven by DUNE physics mission.	Physics TDR. 10 MeV is an achievable parameter; lower thresholds are possible.
DP-DAQ-9	DAQ deadtime: While taking data within the agreed conditions, the DAQ shall be able to trigger and acquire data without introducing any deadtime.	Driven by DUNE physics mission.	Zero deadtime is an achievable inter-event deadtime but a small deadtime would not significantly compromise physics sensitivity.

**Table A.22:** DP CISC specifications.

Label	Description	Specification (Goal)	Rationale	Validation
DP-FD-5	Liquid argon purity	> 5 ms	Directly impacts the number of electrons received at the CRP collection strips and hence the S/N.	Purity monitors and cosmic ray tracks
DP-FD-15	LAr nitrogen contamination	< 3 ppm	Higher contaminations significantly affect the no. of photons that reach the PMT.	In situ measurement
DP-FD-18	Cryogenic monitoring devices		Constrain uncertainties on detection efficiency, fiducial volume.	ProtoDUNE
DP-FD-25	Non-FE noise contributions	$\ll 1000 e^-$	High S/N for high reconstruction efficiency.	Engineering calculation and ProtoDUNE

## Appendix A. Project document summary

DP-FD-29	Detector uptime	> 98% (> 99%)	Meet physics goals in timely fashion.	ProtoDUNE
DP-FD-30	Individual detector module uptime	> 90% (> 95%)	Meet physics goals in timely fashion.	ProtoDUNE
DP-CISC-1	Noise from Instrumentation devices	$\ll 1000 e^-$	Max noise for 5:1 S/N for a MIP passing near cathode; per SBND and DUNE CE	ProtoDUNE
DP-CISC-2	Max. E field near instrumentation devices	< 30 kV/cm (< 15 kV/cm)	Significantly lower than max field of 30 kV/cm per DUNE HV	3D electrostatic simulation
DP-CISC-3	Precision in electron lifetime	< 2.3% (< 1%)	Required to accurately reconstruct charge per DUNE-FD Task Force report.	ProtoDUNE and CITF
DP-CISC-4	Range in electron lifetime	0.04 ms to 10 ms in cryostat, 0.04 ms to 30 ms inline	Slightly more than best values so far observed in other detectors.	ProtoDUNE and CITF
DP-CISC-11	Precision: temperature reproducibility	< 5 mK (2 mK)	Allows validating CFD models that predict gradients less than 15 mK.	ProtoDUNE and CITF
DP-CISC-14	Temperature stability	< 2 mK at all places and times (Match precision requirement at all places, at all times)	Measures temperature map with sufficient precision for the duration of thermometer operations.	ProtoDUNE
DP-CISC-27	Cold camera coverage	> 80% of HV surfaces (100%)	Enables detailed inspection of issues near HV surfaces.	Calculated from location, validated in prototypes.
DP-CISC-51	Slow control alarm rate	< 150/day (< 50/day)	Keeps rate low enough to allow response to every alarm.	Detector module; depends on experimental conditions
DP-CISC-52	Total No. of variables	> 150,000 (150,000 to 200,000)	Scaled from ProtoDUNE	ProtoDUNE and CITF
DP-CISC-54	Archiving rate	0.02 Hz (Broad range 1 Hz to 1 per few min.)	Archiving rate differs by variable, optimized to store important information	ProtoDUNE

### A.5 Risks

DUNE initiated a risk registry in 2018 (available in DocDB 6443 [70]). This document includes consortium risks and technical coordination risks. It includes a summary of the most significant overall DUNE risks. This registry has been updated for the TDR and the full listing can be found in appendix A.6. We expect to update it approximately yearly. The previous update occurred in early 2018 before ProtoDUNE was completed and the most recent update is for the TDR. Another update is planned for 2020. LBNF and DUNE-U.S. would like DUNE to update and expand this risk register to allow a Monte Carlo (MC) analysis of cost and schedule risks to the U.S. project resulting from international DUNE risks. This request is under consideration as it may be useful for other national projects as well. Successfully operating ProtoDUNE retired many DUNE risks in

DUNE. This includes most risks associated with the technical design, production processes, QA, integration, and installation. Residual risks remain relating to design and production modifications associated with scaling to DUNE, mitigations to known installation and performance issues in ProtoDUNE, underground installation at SURF, and organizational growth.

The highest technical risks include development of a system to deliver 600 kV to the DP cathode; general delivery of the required HV; cathode and FC discharge to the cryostat membrane; noise levels, particularly for the CE; number of dead channels; lifetime of components surpassing 20 years; QC of all components; verification of improved LEM performance; verification of new cold ADC and COLDATA performance; argon purity; electron drift lifetime; photoelectron light yield; incomplete calibration plan; and incomplete connection of design to physics. Other significant risks include insufficient funding, optimistic production schedules, incomplete plans for integration, testing and installation.

One update to the risk registry since 2018 has been for technical coordination, to add some risks associated with DUNE integration and installation (see Volume IV, The DUNE far detector single-phase technology, chapter 9, table 9.2)

In addition to installation-related risks, technical coordination is developing its own set of overall project risks not captured by consortia. Key risks for technical coordination to manage include the following:

1. Consortia leave too much scope unaccounted for and too much falls to the common fund.
2. Insufficient organizational systems are put into place to ensure that this complex, international mega-science project, including technical coordination, Fermilab as host laboratory, SURF, DOE, and all international partners continue to work together successfully to ensure that appropriate processes and services are provided for the success of the project.
3. Inability of technical coordination to obtain sufficient personnel resources to ensure that technical coordination can oversee and coordinate all project tasks. While the USA, as host country, has a special responsibility to technical coordination, personnel resources should be directed to technical coordination from each collaborating country.

The consortia have provided preliminary versions of risk analyses that have been collected on the technical coordination webpage (DocDB 6443 [70]). These have been developed into an overall risk register that will be monitored and maintained by technical coordination in coordination with the consortia. This full set of risks can be found in section A.6.

## A.6 Full DUNE risks

### A.6.1 Single-phase

**Table A.23:** APA risks (P=probability, C=cost, S=schedule) The risk probability, after taking into account the planned mitigation activities, is ranked as L (low < 10 %), M (medium 10 % to 25 %), or H (high > 25 %). The cost and schedule impacts are ranked as L (cost increase < 5 %, schedule delay < 2 months), M (5 % to 25 % and 2–6 months, respectively) and H (> 20 % and > 2 months, respectively).

ID	Risk	Mitigation	P	C	S
RT-SP-APA-01	Loss of key personnel	Implement succession planning and formal project documentation	L	L	M
RT-SP-APA-02	Delay in finalisation of APA frame design	Close oversight on prototypes and interface issues	L	L	M
RT-SP-APA-03	One additional pre-production APA may be necessary	Close oversight on approval of designs, commissioning of tooling and assembly procedures	L	L	L
RT-SP-APA-04	APA winder construction takes longer than planned	Detailed plan to stand up new winding machines at each facility	M	L	M
RT-SP-APA-05	Poor quality of APA frames and/or inaccuracy in the machining of holes and slots	Clearly specified requirements and seek out backup vendors	L	L	M
RT-SP-APA-06	Insufficient scientific manpower at APA assembly factories	Get institutional commitments for requests of necessary personnel in research grants	M	M	L
RT-SP-APA-07	APA production quality does not meet requirements	Close oversight on assembly procedures	L	M	M
RT-SP-APA-08	Materials shortage at factory	Develop and execute a supply chain management plan	M	L	L
RT-SP-APA-09	Failure of a winding machine - Drive chain parts failure	Regular maintenance and availability of spare parts	L	L	L
RT-SP-APA-10	APA assembly takes longer time than planned	Estimates based on protoDUNE. Formal training of every tech/operator	L	M	M
RT-SP-APA-11	Loss of one APA due to an accident	Define handling procedures supported by engineering notes	M	L	L
RT-SP-APA-12	APA transport box inadequate	Construction and test of prototype transport boxes	L	L	M
RO-SP-APA-01	Reduction of the APA assembly time	Improvements in the winding head and wire tension measurements	M	M	M

**Table A.24:** HV risks (P=probability, C=cost, S=schedule) The risk probability, after taking into account the planned mitigation activities, is ranked as L (low < 10 %), M (medium 10 % to 25 %), or H (high > 25 %). The cost and schedule impacts are ranked as L (cost increase < 5 %, schedule delay < 2 months), M (5 % to 25 % and 2–6 months, respectively) and H (> 20 % and > 2 months, respectively).

ID	Risk	Mitigation	P	C	S
RT-SP-HV-01	Open circuit on the field cage divider chain	Component selection and cold tests. Varistor protection.	L	L	L
RT-SP-HV-02	Damage to the resistive Kapton film on CPA	Careful visual inspection of panel surfaces. Replace panel if scratches are deep and long	L	L	L
RT-SP-HV-03	Sole source for Kapton resistive surface; and may go out of production	Another potential source of resistive Kapton identified. Possible early purchase if single source.	M	L	L
RT-SP-HV-04	Detector components are damaged during shipment to the far site	Spare parts at LW. FC/CPA modules can be swapped and replaced from factories in a few days.	L	L	L
RT-SP-HV-05	Damages (scratches, bending) to aluminum profiles of Field Cage modules	Require sufficient spare profiles for substitution. Alternate: local coating with epoxy resin.	L	L	L
RT-SP-HV-06	Electric field uniformity is not adequate for muon momentum reconstruction	Redundant components; rigorous screening. Structure based on CFD. Calibration can map E-field.	L	L	L
RT-SP-HV-07	Electric field is below goal during stable operations	Improve the protoDUNE SP HVS design to reduce surface E-field and eliminate exterior insulators.	M	L	L
RT-SP-HV-08	Damage to CE in event of discharge	HVS was designed to reduce discharge to a safe level. Higher resistivity cathode could optimize.	L	L	L
RT-SP-HV-09	Free hanging frames can swing in the fluid flow	Designed for flow using fluid model; Deformation can be calibrated by lasers or cosmic rays.	L	L	L
RT-SP-HV-10	FRP/ Polyethene/ laminated Kapton component lifetime is less than expected	Positive experience in other detectors. Gain experience with LAr TPC's; exchangeable feedthrough.	L	L	L
RT-SP-HV-11	International funding level for SP HVS too low	Cost reduction through design optimization. Effort to increase international collaboration.	M	M	M
RT-SP-HV-12	Underground installation is more labor intensive or slower than expected	SWF contingency, full-scale trial before installation. Estimates based on ProtoDUNE experience.	L	L	L



**Table A.25:** TPC electronics risks (P=probability, C=cost, S=schedule) The risk probability, after taking into account the planned mitigation activities, is ranked as L (low < 10 %), M (medium 10 % to 25 %), or H (high > 25 %). The cost and schedule impacts are ranked as L (cost increase < 5 %, schedule delay < 2 months), M (5 % to 25 % and 2–6 months, respectively) and H (> 20 % and > 2 months, respectively).

ID	Risk	Mitigation	P	C	S
RT-SP-TPC-001	Cold ASIC(s) not meeting specifications	Multiple designs, use of appropriate design rules for operation in LAr	H	M	L
RT-SP-TPC-002	Delay in the availability of ASICs and FEMBs	Increase pool of spares for long lead items, multiple QC sites for ASICs, appropriate measures against ESD, monitoring of yields	M	L	L
RT-SP-TPC-003	Damage to the FEMBs / cold cables during or after integration with the APAs	Redesign of the FEMB/cable connection, use of CE boxes, ESD protections, early integration tests	M	L	L
RT-SP-TPC-004	Cold cables cannot be run through the APAs frames	Redesign of APA frames, integration tests at Ash River and at CERN, further reduction of cable plant	L	L	L
RT-SP-TPC-005	Delay and/or damage to the TPC electronics components on the top of the cryostat	Sufficient spares, early production and installation, ESD protection measures	L	L	L
RT-SP-TPC-006	Interfaces between TPC electronics and other consortia not adequately defined	Early integration tests, second run of ProtoDUNE-SP with pre-production components	M	L	L
RT-SP-TPC-007	Insufficient number of spares	Early start of production, close monitoring of usage of components, larger stocks of components with long lead times	M	L	L
RT-SP-TPC-008	Loss of key personnel	Distributed development of ASICs, increase involved of university groups, training of younger personnel	H	L	M
RT-SP-TPC-009	Excessive noise observed during detector commissioning	Enforce grounding rules, early integration tests, second run of ProtoDUNE-SP with pre-production components, cold box testing at SURF	L	L	M
RT-SP-TPC-010	Lifetime of components in the LAr	Design rules for cryogenic operation of ASICs, measurement of lifetime of components, reliability studies	L	n/a	n/a
RT-SP-TPC-011	Lifetime of components on the top of the cryostat	Use of filters on power supplies, stockpiling of components that may become obsolete, design rules to minimize parts that need to be redesigned / refabricated	L	M	L

**Table A.26:** PD system risks (P=probability, C=cost, S=schedule) The risk probability, after taking into account the planned mitigation activities, is ranked as L (low < 10 %), M (medium 10 % to 25 %), or H (high > 25 %). The cost and schedule impacts are ranked as L (cost increase < 5 %, schedule delay < 2 months), M (5 % to 25 % and 2–6 months, respectively) and H (> 20 % and > 2 months, respectively).

ID	Risk	Mitigation	P	C	S
RT-SP-PD-01	Additional photosensors and engineering required to ensure PD modules collect enough light to meet system physics performance specifications.	Extensive validation of X-ARAPUCA design to demonstrate they meet specification.	L	M	L
RT-SP-PD-02	Improvements to active ganging/front end electronics required to meet the specified 1 $\mu$ s time resolution.	Extensive validation of photosensor ganging/front end electronics design to demonstrate they meet specification.	L	L	L
RT-SP-PD-03	Evolutions in the design of the photon detectors due to validation testing experience require modifications of the TPC elements at a late time.	Extensive validation of X-ARAPUCA design to demonstrate they meet specification and control of PD/APA interface.	L	L	L
RT-SP-PD-04	Cabling for PD and CE within the APA frame or during the 2-APA assembly/installation procedure require additional engineering/development/testing.	Validation of PD/APA/CE cable routing in prototypes at Ash River.	L	L	L
RT-SP-PD-05	Experience with validation prototypes shows that the mechanical design of the PD is not adequate to meet system specifications.	Early validation of X-ARAPUCA prototypes and system interfaces to catch problems ASAP.	L	L	L
RT-SP-PD-06	pTB WLS filter coating not sufficiently stable, contaminates LAr.	Mechanical acceleration of coating wear. Long-term tests of coating stability.	L	L	L
RT-SP-PD-07	Photosensors fail due to multiple cold cycles or extended cryogen exposure.	Execute testing program for cryogenic operation of photosensors including multiple cryogenic immersion cycles.	L	L	L
RT-SP-PD-08	SiPM active ganging cold amplifiers fail or degrade detector performance.	Validation testing if photosensor ganging in multiple test beds.	L	L	L
RT-SP-PD-09	Previously undetected electro-mechanical interference discovered during integration.	Validation of electromechanical design in Ash River tests and at ProtoDUNE-SP-2.	L	L	L
RT-SP-PD-10	Design weaknesses manifest during module logistics-handling.	Validation of shipping packaging and handling prior to shipping. Inspection of modules shipped to site immediately upon receipt.	L	L	L

## Appendix A. Project document summary

RT-SP-PD-11	PD/CE signal crosstalk.	Validation in ProtoDUNE-SP, ICEBERG and ProtoDUNE-SP-2.	L	L	L
RT-SP-PD-12	Lifetime of PD components outside cryostat.	Specification of environmental controls to mitigate detector aging.	L	L	L

**Table A.27:** Calibration risks (P=probability, C=cost, S=schedule) The risk probability, after taking into account the planned mitigation activities, is ranked as L (low < 10%), M (medium 10% to 25%), or H (high > 25%). The cost and schedule impacts are ranked as L (cost increase < 5%, schedule delay < 2 months), M (5% to 25% and 2–6 months, respectively) and H (> 20% and > 2 months, respectively).

ID	Risk	Mitigation	P	C	S
RT-SP-CAL-01	Inadequate baseline design	Early detection allows R&D of alternative designs accommodated through multipurpose ports	L	M	M
RT-SP-CAL-02	Inadequate engineering or production quality	Dedicated small scale tests and full prototyping at ProtoDUNE; pre-installation QC	L	M	M
RT-SP-CAL-03	Laser impact on PDS	Mirror movement control to avoid direct hits; turn laser off in case of PDS saturation	L	L	L
RT-SP-CAL-04	Laser beam location system stops working	QC at installation time, redundancy in available targets, including passive, alternative methods	L	L	L
RT-SP-CAL-05	Laser beam misaligned	Additional (visible) laser for alignment purposes	M	L	L
RT-SP-CAL-06	The neutron anti-resonance is much less pronounced	Dedicated measurements at LANL and test at ProtoDUNE	L	L	L
RT-SP-CAL-07	Neutron activation of the moderator and cryostat	Neutron activation studies and simulations	L	L	L
RT-SP-CAL-08	Neutron yield not high enough	Simulations and tests at ProtoDUNE; alternative, movable design	L	M	M
RO-SP-CAL-09	Laser beam is stable at longer distances than designed	tests at ProtoDUNE	M	H	L

2020 JINST 15 T08009

**Table A.28:** DAQ risks (P=probability, C=cost, S=schedule) The risk probability, after taking into account the planned mitigation activities, is ranked as L (low < 10 %), M (medium 10 % to 25 %), or H (high > 25 %). The cost and schedule impacts are ranked as L (cost increase < 5 %, schedule delay < 2 months), M (5 % to 25 % and 2–6 months, respectively) and H (> 20 % and > 2 months, respectively).

ID	Risk	Mitigation	P	C	S
RT-SP-DAQ-01	Detector noise specs not met	ProtoDUNE experience with noise levels and provisions for data processing redundancy in DAQ system; ensure enough headroom of bandwidth to FNAL.	L	L	L
RT-SP-DAQ-02	Externally-driven schedule change	Provisions for standalone testing and commissioning of production DAQ components, and schedule adjustment	L	L	L
RT-SP-DAQ-03	Lack of expert personnel	Resource-loaded plan for DAQ backed by institutional commitments, and schedule adjustment using float	L	L	H
RT-SP-DAQ-04	Power/space requirements exceed CUC capacity	Sufficient bandwidth to surface and move module 3/4 components to an expanded surface facility	L	L	L
RT-SP-DAQ-05	Excess fake trigger rate from instrumental effects	ProtoDUNE performance experience, and provisions for increase in event builder and high level filter capacity, as needed; headroom in data link to FNAL.	L	L	L
RT-SP-DAQ-06	Calibration requirements exceed acceptable data rate	Provisions for increase in event builder and high level filter capacity, as needed; headroom in data link to FNAL.	L	L	L
RT-SP-DAQ-07	Cost/performance of hardware/computing excessive	Have prototyping and pre-production phases, reduce performance using margin or identify additional funds	L	L	L
RT-SP-DAQ-08	PDTS fails to scale for DUNE requirements	Hardware upgrade	L	L	L
RT-SP-DAQ-09	WAN network	Extensive QA and development of failure mode recovery and automation, improved network connectivity, and personnel presence at SURF as last resort.	L	M	M
RT-SP-DAQ-10	Infrastructure	Design with redundancy, prior to construction, and improve power/cooling system.	M	M	L
RT-SP-DAQ-11	Custom electronics manufacturing issues	Diversify the manufacturers used for production; run an early pre-production and apply stringent QA criteria.	L	M	M

**Table A.29:** CISC risks (P=probability, C=cost, S=schedule) The risk probability, after taking into account the planned mitigation activities, is ranked as L (low < 10 %), M (medium 10 % to 25 %), or H (high > 25 %). The cost and schedule impacts are ranked as L (cost increase < 5 %, schedule delay < 2 months), M (5 % to 25 % and 2–6 months, respectively) and H (> 20 % and > 2 months, respectively).

ID	Risk	Mitigation	P	C	S
RT-SP-CISC-01	Baseline design from ProtoDUNEs for an instrumentation device is not adequate for DUNE far detectors	Focus on early problem discovery in ProtoDUNE so any needed redesigns can start as soon as possible.	L	M	L
RT-SP-CISC-02	Swinging of long instrumentation devices (T-gradient monitors or PrM system)	Add additional intermediate constraints to prevent swinging.	L	L	L
RT-SP-CISC-03	High E-fields near instrumentation devices cause dielectric breakdowns in LAr	CISC systems placed as far from cathode and FC as possible.	L	L	L
RT-SP-CISC-04	Light pollution from purity monitors and camera light emitting system	Use PrM lamp and camera lights outside PDS trigger window; cover PrM cathode to reduce light leakage.	L	L	L
RT-SP-CISC-05	Temperature sensors can induce noise in cold electronics	Check for noise before filling and remediate, repeat after filling. Filter or ground noisy sensors.	L	L	L
RT-SP-CISC-06	Disagreement between lab and <i>in situ calibrations for ProtoDUNE-SP dynamic T-gradient monitor</i>	Investigate and improve both methods, particularly laboratory calibration.	M	L	L
RT-SP-CISC-07	Purity monitor electronics induce noise in TPC and PDS electronics.	Operate lamp outside TPC+PDS trigger window. Surround and ground light source with Faraday cage.	L	L	L
RT-SP-CISC-08	Discrepancies between measured temperature map and CFD simulations in ProtoDUNE-SP	Improve simulations with additional measurements inputs; use fraction of sensors to predict others	L	L	L
RT-SP-CISC-09	Difficulty correlating purity and temperature in ProtoDUNE-SP impairs understanding cryo system.	Identify causes of discrepancy, modify design. Calibrate PrM differences, correlate with RTDs.	L	L	L
RT-SP-CISC-10	Cold camera R&D fails to produce prototype meeting specifications & safety requirements	Improve insulation and heaters. Use cameras in ullage or inspection cameras instead.	M	M	L
RT-SP-CISC-11	HV discharge caused by inspection cameras	Study E-field in and on housing and anchoring system. Test in HV facility.	L	L	L
RT-SP-CISC-12	HV discharge destroying the cameras	Ensure sufficient redundancy of cold cameras. Warm cameras are replaceable.	L	M	L

## Appendix A. Project document summary

RT-SP-CISC-13	Insufficient light for cameras to acquire useful images	Test cameras with illumination similar to actual detector.	L	L	L
RT-SP-CISC-14	Cameras may induce noise in cold electronics	Continued R&D work with grounding and shielding in realistic conditions.	L	L	L
RT-SP-CISC-15	Light attenuation in long optic fibers for purity monitors	Test the max. length of usable fiber, optimize the depth of bottom PrM, number of fibers.	L	L	L
RT-SP-CISC-16	Longevity of purity monitors	Optimize PrM operation to avoid long running in low purity. Technique to protect/recover cathode.	L	L	L
RT-SP-CISC-17	Longevity: Gas analyzers and level meters may fail.	Plan for future replacement in case of failure or loss of sensitivity.	M	M	L
RT-SP-CISC-18	Problems in interfacing hardware devices (e.g. power supplies) with slow controls	Involve slow control experts in choice of hardware needing control/monitoring.	L	L	L

**Table A.30:** SP module installation risks (P=probability, C=cost, S=schedule) The risk probability, after taking into account the planned mitigation activities, is ranked as L (low < 10 %), M (medium 10 % to 25 %), or H (high > 25 %). The cost and schedule impacts are ranked as L (cost increase < 5 %, schedule delay < 2 months), M (5 % to 25 % and 2–6 months, respectively) and H (> 20 % and > 2 months, respectively).

ID	Risk	Mitigation	P	C	S
RT-INST-01	Personnel injury	Follow established safety plans.	M	L	H
RT-INST-02	Shipping delays	Plan one month buffer to store materials locally. Provide logistics manual.	H	L	L
RT-INST-03	Missing components cause delays	Use detailed inventory system to verify availability of necessary components.	H	L	L
RT-INST-04	Import, export, visa issues	Dedicated Fermilab SDSDDivision will expedite import/export and visa-related issues.	H	M	M
RT-INST-05	Lack of available labor	Hire early and use Ash River setup to train JPO crew.	L	L	L
RT-INST-06	Parts do not fit together	Generate 3D model, create interface drawings, and prototype detector assembly.	H	L	L
RT-INST-07	Cryostat damage	Use cryostat false floor and temporary protection.	L	L	M
RT-INST-08	Weather closes SURF	Plan for SURF weather closures	H	L	L
RT-INST-09	Detector failure during cool-down	Cold test individual components then cold test APA assemblies immediately before installation.	L	H	H

2020 JINST 15 T08009

### A.6.2 Dual-phase

For each risk, the risk probability, after taking into account the planned mitigation activities, is ranked as L (low < 10 %), M (medium 10 % to 25 %), or H (high > 25 %). The cost and schedule impacts are ranked as L (cost increase < 5 %, schedule delay < 2 months), M (5 % to 25 % and 2–6 months, respectively) and H (> 20 % and > 2 months, respectively).

**Table A.31:** Risks for DP-FD-CRP (P=probability, C=cost, S=schedule) More information at risk probabilities.

ID	Risk	Mitigation	P	C	S
RT-DP-CRP-01	Poor quality of G10 frames and/or inaccuracy in the hole machining	Clearly specified requirements, followup and seek out backup vendors	L	L	M
RT-DP-CRP-02	LEM production takes longer than expected	Define a production schedule allowing enough contingencies to limit the assembly impact	L	L	M
RT-DP-CRP-03	One of the CRP assembly site not ready on time	Close oversight on construction of tooling and preparation of assembly sites	L	M	H
RT-DP-CRP-04	Materials shortage at production site	Develop and execute a supply chain management	M	L	L
RT-DP-CRP-05	Failure of extraction grid winding machine	Regular maintenance and availability of spare parts	L	L	L
RT-DP-CRP-06	CRP assembly takes longer time than planned	Estimates based on ProtoDUNE-DP. Formal training of every tech/operator at each site.	L	M	M

**Table A.32:** Risks for DP-FD-HV (P=probability, C=cost, S=schedule) More information at risk probabilities.

ID	Risk	Mitigation	P	C	S
RT-DP-HV-01	Broken resistors or varistors on voltage divider boards	Redundancy of resistors, varistors, and .	L	L	L
RT-DP-HV-02	E field uniformity is not adequate for muon momentum reconstruction	Regularly map out field using a laser calibration system.	L	L	L
RT-DP-HV-03	E field is below specification during stable operations	Improve purity by more aggressive filtering.	M	M	L
RT-DP-HV-04	Space charge from positive ions distorting the E field beyond expectation	Minimize insulators facing cryostat wall ground.	M	M	L
RT-DP-HV-05	Damage to CE in event of discharge	Minimize the energy released in a short time using highly resistive connections.	L	L	L
RT-DP-HV-06	Energy stored in FC (in DP) is suddenly discharged	Delay energy discharge by connecting neighboring Al profiles with resistive sheaths.	L	L	L
RT-DP-HV-07	Detector components are damaged during shipment to the far site	Make sufficient spares and increase the number of shipping boxes.	L	L	L

## Appendix A. Project document summary

RT-DP-HV-08	Damages (scratches, bending) to aluminum profiles of Field Cage modules	Make sufficient spares and increase the number of shipping boxes.	L	L	L
RT-DP-HV-09	Bubbles from heat in PMTs or resistors cause HV discharge	A large area of cathode consists of high resistance rods, delaying the energy release.	L	L	L
RT-DP-HV-10	Free hanging frames can swing in the fluid flow		L	L	L
RT-DP-HV-11	FRP/ Polyethylene/ laminated Kapton component lifetime is less than expected		L	L	L
RT-DP-HV-12	Lack of collaboration effort on this HV system	Continue recruiting collaborators.	L	L	L
RT-DP-HV-13	International funding level for DP HVC too low	Employ cost saving measures and recruit collaborators.	L	L	L
RT-DP-HV-14	Underground installation is more labor intensive or slower than expected	Increase labor contingency and refine labor cost estimates. Further improve installation procedure.	L	L	L

**Table A.33:** Risks for DP-FD-TPC (P=probability, C=cost, S=schedule) More information at risk probabilities.

ID	Risk	Mitigation	P	C	S
RT-DP-TPC-01	Component obsolescence over the experiment lifetime	Monitor component stocks and procure an adequate number of spares at the time of production	L	M	L
RT-DP-TPC-02	Modification to the LRO FE electronics due to evolution in design of PD design	A strict and timely following of the evolution of DP PDS	L	L	M
RT-DP-TPC-03	Damage to electronics due to HV discharges or other causes	FE analog electronics is protected with TVS diodes. Electronics can be easily replaced.	L	L	L
RT-DP-TPC-04	Problems with FE card extraction due to insufficient overhead clearance	Addressed by imposing a clearance requirement on LBNF	L	L	L
RT-DP-TPC-05	Overpressure in the SFT chimneys	The SFT chimneys are equipped with overpressure release valves	L	L	L
RT-DP-TPC-06	Leak of nitrogen inside the DP module via cold flange	Monitor chimney pressure for leaks and switch to argon cooling in case of a leak	L	L	L
RT-DP-TPC-07	Data flow increase due to inefficient compression caused by higher noise	Have a sufficiently large (a factor of 5) margin in the available bandwidth	L	L	L
RT-DP-TPC-08	Damage to $\mu$ TCA crates due to presence of water on the roof of the cryostat	LBNF requirement that the cryostat top remains dry	L	L	L
RT-DP-TPC-09	Clogging ventilation system of $\mu$ TCA crates due to bad air quality	LBNF requirement that the air quality is comparable to a standard industrial environment	L	L	L

2020 JINST 15 T08009



**Table A.34:** Risks for DP-FD-PDS (P=probability, C=cost, S=schedule) More information at risk probabilities.

ID	Risk	Mitigation	P	C	S
RT-DP-PDS-01	Insufficient light yield due to inefficient PDS design	Increase PMT photo-cathode coverage and/or WLS reflector foils coverage.	L	M	L
RT-DP-PDS-02	Poor coating quality for TPB coated surfaces and LAr contamination by TPB	Test quality and ageing properties of TPB coating techniques. Elaborate improved techniques if needed.	L	L	L
RT-DP-PDS-03	PMT channel loss due to faulty PMT base design	Optimize clustering algorithms. Improve PMT base design from analysis of possible failure modes in ProtoDUNE-DP.	L	L	L
RT-DP-PDS-04	Bad PMT channel due to faulty connection between HV/signal cable and PMT base	Optimize clustering algorithms. Connectivity tests in LN <sub>2</sub> prior to installation.	L	L	L
RT-DP-PDS-05	PMT signal saturation	Tuning of PMT gain. In worst case, redesign front-end to adjust to analog input range of ADC.	M	L	L
RT-DP-PDS-06	Excessive electronics noise to distinguish LAr scintillation light	Measurement of noise levels during commissioning prior to LAr filling. Modifications to grounding, shielding, or power distribution schemes.	M	L	L
RT-DP-PDS-07	Availability of resources for work at the installation/integration site less than planned	Move people temporarily from institutions involved in the PD system consortium to the integration/installation site.	L	L	L
RT-DP-PDS-08	Damage of PMTs during shipment to the experiment site	Special packaging to avoid possible PMT damage during shipment. Contingency of 10% spare PMTs.	L	L	L
RT-DP-PDS-09	Damage of optical fibers during installation	Fibers will be last DP-PDS item to be installed. Detailed documentation for all DP-PDS installation tasks.	L	L	L
RT-DP-PDS-10	Excessive exposure to ambient light of TPB coated surfaces, resulting in degraded performance	TPB coated surfaces temporarily covered until cryostat closing. Detailed installation procedure to minimize exposure to ambient light.	L	L	L
RT-DP-PDS-11	PMT implosion during LAr filling	No mitigation necessary, considering 7 bar pressure rating of PMTs and experience with same/similar PMTs in other large liquid detectors.	L	L	L
RT-DP-PDS-12	Insufficient light yield due to poor LAr purity	Procurement of LAr from the manufacturer will require less than 3 ppM in nitrogen.	M	L	L
RT-DP-PDS-13	PMT channel or PD system sector loss due to failures in HV/signal rack	Ease of maintenance outside cryostat and availability of spares for all components of at least one HV/signal rack.	L	L	L

Appendix A. Project document summary

RT-DP-PDS-14	Unstable response of the photon detection system over the lifetime of the experiment	Channel-level instabilities corrected via light calibration system. Detector-level instabilities corrected via cosmic-ray muon calibration data.	L	L	L
RT-DP-PDS-15	Bubbles from heat in PMTs or resistors cause HV discharge of the cathode	Verify the power density of the PMT bases are within specifications. Monitor and interlock PMT power supply currents.	L	L	L
RT-DP-PDS-16	Reflector/WLS panel assemblies together with the FC walls can swing in the fluid flow	Allow appropriate open areas within/between reflector/WLS panel assemblies to minimize drag.	L	L	L

**Table A.35:** Risks for DP-FD-CAL (P=probability, C=cost, S=schedule) More information at risk probabilities.

ID	Risk	Mitigation	P	C	S
RT-DP-CAL-01	Inadequate baseline design	Early detection allows R&D of alternative designs accommodated through multipurpose ports.	L	M	M
RT-DP-CAL-02	Inadequate engineering or production quality	Dedicated small-scale tests and full prototyping at ProtoDUNE; pre-installation QC.	L	M	M
RT-DP-CAL-03	Laser impact on PDS	Mirror movement control to minimize direct hits; intelock to keep laser off while PMTs are on.	L	L	L
RT-DP-CAL-04	Laser positioning system stops working	QC at installation time, redundancy in available targets, including passive, alternative methods.	L	L	L
RT-DP-CAL-05	Laser beam misaligned	Additional (visible) laser for alignment purposes.	M	L	L
RT-DP-CAL-06	The neutron anti-resonance is much less pronounced	Dedicated measurements at LANL and test at ProtoDUNE.	L	L	L
RT-DP-CAL-07	Neutron activation of the moderator and cryostat	Neutron activation studies and simulations.	L	L	L
RT-DP-CAL-08	Neutron yield not high enough	Simulations and tests at ProtoDUNE; alternative, movable design	L	M	M
RO-DP-CAL-09	Laser beam is stable at longer distances than designed	tests at ProtoDUNE	M	H	L

**Table A.36:** Risks for DP-FD-DAQ (P=probability, C=cost, S=schedule) More information at risk probabilities.

ID	Risk	Mitigation	P	C	S
RT-DP-DAQ-01	Detector noise specs not met	ProtoDUNE experience with noise levels and provisions for data processing redundancy in DAQ system; ensure enough headroom of bandwidth to FNAL.	L	L	L

2020 JINST 15 T08009

Appendix A. Project document summary

RT-DP-DAQ-02	Externally-driven schedule change	Provisions for standalone testing and commissioning of production DAQ components, and schedule adjustment	L	L	L
RT-DP-DAQ-03	Lack of expert personnel	Resource-loaded plan for DAQ backed by institutional commitments, and schedule adjustment using float	L	L	H
RT-DP-DAQ-04	Power/space requirements exceed CUC capacity	Sufficient bandwidth to surface and move module 3/4 components to an expanded surface facility	L	L	L
RT-DP-DAQ-05	Excess fake trigger rate from instrumental effects	ProtoDUNE performance experience, and provisions for increase in event builder and high level filter capacity, as needed; headroom in data link to FNAL.	L	L	L
RT-DP-DAQ-06	Calibration requirements exceed acceptable data rate	Provisions for increase in event builder and high level filter capacity, as needed; headroom in data link to FNAL.	L	L	L
RT-DP-DAQ-07	Cost/performance of hardware/computing excessive	Have prototyping and pre-production phases, reduce performance using margin or identify additional funds	L	L	L
RT-DP-DAQ-08	PDTS fails to scale for DUNE requirements	Hardware upgrade	L	L	L
RT-DP-DAQ-09	WAN network	Extensive QA and development of failure mode recovery and automation, improved network connectivity, and personnel presence at SURF as last resort.	L	M	M
RT-DP-DAQ-10	Infrastructure	Design with redundancy, prior to construction, and improve power/cooling system.	M	M	L
RT-DP-DAQ-11	Custom electronics manufacturing issues	Diversify the manufacturers used for production; run an early pre-production and apply stringent QA criteria.	L	M	M

**Table A.37:** Risks for DP-FD-CISC (P=probability, C=cost, S=schedule) More information at risk probabilities.

ID	Risk	Mitigation	P	C	S
RT-DP-CISC-001	Baseline design from ProtoDUNEs for an instrumentation device is not adequate for DUNE far detectors	Focus on early problem discovery in ProtoDUNE so any needed redesigns can start as soon as possible.	L	M	L
RT-DP-CISC-002	Swinging of long instrumentation devices (T-gradient monitors or PrM system)	Add additional intermediate constraints to prevent swinging.	L	L	L
RT-DP-CISC-003	High E-fields near instrumentation devices cause dielectric breakdowns in LAr	CISC systems shielded and placed as far from cathode and FC as possible.	L	L	L

2020 JINST 15 T08009

## Appendix A. Project document summary

RT-DP-CISC-004	Light pollution from purity monitors and camera light emitting system	Use PrM lamp and camera lights outside PDS trigger window; cover PrM cathode to reduce light leakage.	L	L	L
RT-DP-CISC-005	Temperature sensors can induce noise in cold electronics	Check for noise before filling and remediate, repeat after filling. Filter or ground noisy sensors.	L	L	L
RT-DP-CISC-006	Disagreement between lab and <i>in situ</i> calibrations for <i>ProtoDUNE-SP</i> dynamic <i>T-gradient</i> monitor	Investigate and improve both methods, particularly laboratory calibration.	M	L	L
RT-DP-CISC-007	Purity monitor electronics induce noise in TPC and PDS electronics.	Operate lamp outside TPC+PDS trigger window. Surround and ground light source with Faraday cage.	L	L	L
RT-DP-CISC-008	Discrepancies between measured temperature map and CFD simulations in <i>ProtoDUNE-SP</i>	Improve simulations with additional measurements inputs; use fraction of sensors to predict others	L	L	L
RT-DP-CISC-009	Difficulty correlating purity and temperature in <i>ProtoDUNE-SP</i> impairs understanding cryo system.	Identify causes of discrepancy, modify design. Calibrate PrM differences, correlate with RTDs.	L	L	L
RT-DP-CISC-010	Cold camera R&D fails to produce prototype meeting specifications & safety requirements	Improve insulation and heaters. Use cameras in ullage or inspection cameras instead.	M	M	L
RT-DP-CISC-011	HV discharge caused by inspection cameras	Study E-field in and on housing and anchoring system. Test in HV facility.	L	L	L
RT-DP-CISC-012	HV discharge destroying the cameras	Ensure sufficient redundancy of cold cameras. Warm cameras are replaceable.	L	M	L
RT-DP-CISC-013	Insufficient light for cameras to acquire useful images	Test cameras with illumination similar to actual detector.	L	L	L
RT-DP-CISC-014	Cameras may induce noise in cold electronics	Continued R&D work with grounding and shielding in realistic conditions.	L	L	L
RT-DP-CISC-015	Light attenuation in long optic fibers for purity monitors	Test the max. length of usable fiber, optimize the depth of bottom PrM, number of fibers.	L	L	L
RT-DP-CISC-016	Longevity of purity monitors	Optimize PrM operation to avoid long running in low purity. Technique to protect/recover cathode.	L	L	L
RT-DP-CISC-017	Longevity: Gas analyzers and level meters may fail.	Plan for future replacement in case of failure or loss of sensitivity.	M	M	L
RT-DP-CISC-018	Problems in interfacing hardware devices (e.g. power supplies) with slow controls	Involve slow control experts in choice of hardware needing control/monitoring.	L	L	L

2020 JINST 15 T08009

**Table A.38:** Risks for DP-FD-INST (P=probability, C=cost, S=schedule) More information at risk probabilities.

ID	Risk	Mitigation	P	C	S
RT-DPINST-01	Personnel injury	Follow the safety rules in force.	L	L	H
RT-DPINST-02	Cryostat damage during installation	Use temporary protection for the corrugated membrane.	L	L	M
RT-DPINST-03	Detector components damage during transport/installation	Handling should be done by trained people, following the handling instructions provided by the consortia and in presence of a technical expert.	L	M	M
RT-DPINST-04	Detector components failure during test	Only trained people should test equipments. Spare components must be available at the warehouse facility.	L	L	M
RT-DPINST-05	Components interferences	3D model, survey at the construction sites, and full scale assembly tests.	M	L	L
RT-DPINST-06	Shipping delays/missing parts	Buffer material and detector components at the warehouse facility and use inventory tools to follow the fundamental items.	L	L	L
RT-DPINST-07	Lack of specialised/trained manpower	Hire and train personnel. Plan with all the underground stakeholders enough in advance the required personnel.	L	L	L

### A.7 Hazard Analysis Report (HAR)

A key element of an effective ES&H program is the hazard identification process. Hazard identification allows production of a list of hazards within a facility, so these hazards can be screened and managed through a suitable set of controls.

The LBNF/DUNE project completed a HAR to ensure that identified hazards are mitigated early in the design process. The focus of the report is on process hazards, not activity hazards that are typically covered in a job hazard analysis. The HAR has been completed, identifying hazards anticipated in the project’s construction and operational phases.

The hazard HAR looks at the consequences of a hazard to establish a pre-mitigation risk category. Proposed mitigation is applied to hazards of concern to reduce risk and then establishes a post-mitigation risk category.

As the DUNE design matures, the HAR will be updated to ensure that all hazards are properly identified and controlled through design and safety management system programs. In addition, some sections of the HAR are used to meet the safety requirements as defined in 10 CFR 851 and DOE Order 420.2C, Safety of Accelerator Facilities. Table A.39 summarizes these hazards. The sections following the table describe in more detail the hazards that are most applicable to DUNE activities and the design and operational controls used to mitigate these hazards. The results of these evaluations confirm that the potential risks from construction, operations, and maintenance are acceptable. Individual activity-based HA will be developed for each work LBNF/DUNE activity at SURF.

**Table A.39:** List of identified hazards.

HA-1 (Construction)	HA-2 (Natural Phenomena)	HA-3 (Environmental)
Site Clearing, Excavation, Mining, Tunneling (explosives), Vertical/Horizontal Conveyance Systems, Confined space, Heavy Equipment, Work at Elevations (steel, roofing), Material Handling (rigging) Utility interfaces, (electrical, steam, chilled water), Slips/trips/falls, Weather related conditions Scaffolding, Transition to Operations, Radiation Generating Devices	Seismic, Flooding, Wind, Lightning, Tornado	Construction impacts, Storm water discharge (construction and operations), Operations impacts, Soil and groundwater activation/contamination, Tritium contamination, Air activation, Cooling water activation (HVAC and Machine), Oils/chemical leaks or spills, Discharge/emission points (atmospheric/ground)
HA-4 (Waste)	HA-5 (Fire)	HA-6 (Electrical)
Construction Phase, Facility maintenance, Experimental Operations, Industrial, Hazardous, Radiological	Facility Occupancy Classification, Construction Materials, Storage, Flammable/combustible liquids, Flammable gasses, Egress/access, Electrical, Lightning, Welding/cutting/brazing work, Smoking	Facility, Experimental, Job built Equipment, Low Voltage/High Current, High Voltage/High Power, Maintenance, Arc flash, Electrical shock, Cable tray overloading/mixed utilities, Exposed 110V, Stored energy (capacitors & inductors), Be in contactors
HA-7 (Mechanical)	HA-8 (Cryo/ODH)	HA-9 (Confined Space)
Construction Tools, Machine Shop Tools, Industrial Vehicles, Drilling, Cutting, Grinding, Pressure/Vacuum Vessels and Lines, High Temp Equipment (Bakeouts)	Thermal, Cryogenic systems, Pressure, Handling and Storage, Liquid argon/nitrogen spill/leak, Use of inert gases (argon, nitrogen, helium), Specialty gases	Sumps, Utility Chases
HA-11 (Chemical)	HA-14 (Laser)	HA-15 (Material Handling)
Toxic, Compressed gas, Combustibles, Explosives, Flammable gases, Lead (shielding), Cryogenic	Alignment Laser, Testing and Calibration, Magnetic Fields, Calibration & Testing	Overhead cranes/hoists, Fork trucks, Manual material handling, Delivery area distribution, Manual movement of materials, Hoisting & Rigging, Lead, Beryllium Windows,Oils, Solvents, Acids, Cryogens, Compressed Gases

2020 JINST 15 T08009

HA-16 (Experimental Ops)		
Electrical equipment, Water Hazard, Working from heights (scaffolding/lifts), Transportation of hazardous materials, Liquid Argon/Nitrogen, Chemicals (Corrosive, Reactive, Flammable), Elevations, Ionizing radiation, Ozone production, Slips, trips, falls, Machine tools/hand tools, Stray static magnetic fields, Research gasses (Inert, Flammable)		

**A.7.1 Construction hazards (LBNF-DUNE HA-1)**

The project will use the existing work planning and control process for the laboratories along with a construction project safety and health plan to communicate these policies and procedures as required by DOE Order 413.3b. The installation and construction hazards anticipated for the LBNF/DUNE project include the following:

- Site clearing;
- Excavation;
- Installing vertical/horizontal conveyance systems;
- Confined space;
- Heavy equipment operation;
- Work at elevation (erecting steel, roofing);
- Material handling (rigging);
- Utility interfaces (electrical, chilled water, ICW, natural gas);
- Slips/trips/falls;
- Weather related conditions;
- Scaffolding;
- Transition to operations; and
- Devices generating radiation.

To reduce risks from construction hazards, Fermilab will use engineered and approved excavation and fall protection systems. Heavy equipment will use required safety controls. The Fermilab construction safety oversight program includes periodic evaluation of the construction site and construction activities, HA for all subcontractor activities and frequent ES&H communications at the daily tool box meetings of subcontractors.

### **A.7.2 Natural phenomena (LBNF-DUNE HA-2)**

The LBNF/DUNE design will be governed by the International Building Code, 2015 edition; DOE Standard (STD)-1020, 2016 edition, Natural Phenomena Hazard Analysis and Design Criteria for DOE Facilities, guided the design in meeting the natural phenomena hazard requirements. The International Building Code specifies design criteria for wind loading, snow loading, and seismic events.

LBNF/DUNE was determined to be a low-hazard, performance category 1 facility according to the DOE STD-1021-93. LBNF/DUNE areas will contain small quantities of activated, radioactive, and hazardous chemical materials. Should a natural phenomenon hazard cause significant damage, the impact will be mission-related and will not pose a hazard to the public or the environment.

### **A.7.3 Environmental hazards (LBNF-DUNE HA-3)**

Environmental hazards from DUNE include potentially releasing chemicals to soil, groundwater, surface water, air, or sanitary sewer systems that could, if not controlled, exceed regulatory limits.

Fermilab maintains an environmental management system equivalent to ISO 14001, consisting of programs for protecting the environment, assuring compliance with applicable environmental regulations and standards, and avoiding adverse environmental impact through continual improvement. These programs are documented in the 8000 and 11000 series of chapters in the FESHM. The environmental mitigation plan also meets federal and state regulations.

### **A.7.4 Waste hazards (LBNF-DUNE HA-4)**

Waste-related hazards from DUNE include the potential for releasing waste materials (oils, solvents, chemicals, and radioactive material) to the environment, injury to personnel, and reactive or explosive event. Typical initiators will be transportation accidents, incompatible materials, insufficient packaging or labeling, failure of packaging, and a natural phenomenon.

During installation and DUNE operation, we anticipate few hazardous materials will be used. Such materials include paints, epoxies, solvents, oils, and lead in the form of shielding. No current or anticipated activities at DUNE would expose workers to levels of contaminants (dust, mists, or fumes) above regulatory limits.

The ES&H&Q section industrial hygiene group and hazard control technology team manage the program and guide collaborators subject to waste-related hazards. Their staff identify workplace hazards, help identify controls, and monitor implementation. Industrial hygiene hazards will be evaluated, identified, and mitigated as part of the work planning and control hazard assessment process.

### **A.7.5 Fire hazards (LBNF-DUNE HA-5)**

Fire hazards have been evaluated and addressed to comply with DOE Order 420.1C, Facility Safety, Chapter II and DOE-STD 1066, Fire Protection Design Criteria. The intent of these documents is to meet DOE's highly protected risk (HPR) approach to fire protection. In addition, the National Fire Protection Association Standard 520, Standard on Subterranean Spaces, was used in developing the basis for design related to fire protection/life safety.



The combustible loads and the use of flammable and/or reactive materials in the LBNF/DUNE facility are controlled following the International Building Code building occupancy classification. Certain ancillary buildings outside the main structure may be classified as higher hazard areas (Use Group H occupancy), including the gas cylinder and chemical storage rooms, because they hold more concentrated quantities of flammable or combustible materials. The control area concept used in the International Building Code and National Fire Protection Association standards will be followed for hazardous chemical use and storage areas to provide the most flexibility and control of materials by allowing individual inventory thresholds per control area. The LBNF/DUNE facility will be equipped with fire detection systems and alarm systems that will monitor water flow in case of fire suppression activation, as well as monitor control valves and detection systems.

Audible/visual alarm notification devices will alert building occupants. Manual pull stations for the fire alarms will be installed at all building exits. Following National Fire Protection Association 90A, air handling systems will have photoelectric smoke detectors. Smoke detection will be provided in areas with highly sensitive electronic equipment. Combinations of audible and visual alarm notification devices will be set up throughout the underground enclosures and service buildings to alert occupants. All fire alarm signals will report through a centralized system at SURF. Fire alarm and supervisory signals will be transmitted to internal and external emergency responders using the campus reporting system.

While fixed fire protection systems afford an excellent level of protection, additional strategies that include operational controls that minimize combustible materials, adequately fused power supplies, fire safety inspections, and operational readiness reviews will be used to further reduce fire hazards within the facility following DOE highly protected risk methods.

Experimental cabling will meet the requirements of the National Fire Protection Association 70 and National Electrical Code, 2015 edition. Preferred cables will be fire resistant, using appropriately designated cable types for plenum or general-purpose cables. When there is a large investment in equipment for experiment power or computer rack systems, or when equipment is custom-made (as opposed to off-the-shelf commercial electronics), a device to detect faults or smoke in the system will be provided. This device will also shut down the individual rack or racks when smoke or faults are detected.

#### **A.7.6 Electrical hazards (LBNF-DUNE HA-6)**

LBNF/DUNE will have significant facility-related systems and subsystems that produce or use high voltage, high current, or high levels of stored energy, all of which can present electrical hazards to personnel. Electrical hazards include electric shock and arc flash from exposed conductors, defective and substandard equipment, lack of training, or improper procedures.

Fermilab has a well-established electrical safety program that incorporates de-energizing equipment, isolation barriers, PPE, and training. The cornerstone of the program is the lockout/tagout following the FESHM chapter 2100, Fermilab Energy Control Program (Lockout/Tagout).

Design, installation, and operation of electrical equipment will comply with the National Electrical code (NFPA 70), applicable parts of Title 29 Code of Federal Regulations, Parts 1910 and 1926, National Fire Protection Association 70E, and Fermilab electrical safety policies documented in the FESHM 9000 series chapters. Equipment procured from outside vendors or international in-kind partners will be either certified by a nationally recognized testing laboratory, conform to

international standards previously evaluated and deemed equivalent to USA standards, or inspected and accepted using Fermilab's electrical equipment inspection policies outlined in FESHM 9110, Electrical Utilization Equipment Safety.

#### **A.7.7 Noise/vibration/thermal/mechanical (LBNF-DUNE HA-7)**

Hazards include overexposure of personnel to noise and vibrations as specified by the American Conference of Governmental Industrial Hygienists and US Occupational Safety and Health Administration (OSHA), which set noise limits to avoid permanent hearing loss, also known as permanent threshold shift. Vibration of equipment can contribute to noise levels and could damage or interfere with sensitive equipment.

LBNF/DUNE will use a wide variety of equipment that will produce a wide range of noise and vibration. Support equipment, such as pumps, motors, fans, machine shops, and general HVAC all contribute to point source and overall ambient noise levels. While noise will typically be below the ACGIH and OSHA eight-hour time-weighted average, certain areas with mechanical equipment could exceed that criterion and will require periodic monitoring, posting, and use of protective equipment. Ambient background noise is more a concern for collaborator comfort, stress level, and fatigue.

The detector facilities use a wide variety of noisy equipment. Items such as pumps, fans, and machine shop devices are possible sources of noise levels that might exceed the Fermilab noise action levels. FESHM chapter 4140, Hearing Conservation, details requirements for reducing noise and protecting personnel exposed to excessive noise levels. Warning signs are posted wherever hazardous noise levels may occur, and hearing protection devices are readily available. Ways to reduce noise and vibration will be incorporated into the LBNF/DUNE design. These techniques include using low-noise and low-vibration-producing equipment, especially for fans in the HVAC equipment, isolating noise-producing equipment by segregating or enclosing it, and using sound deadening materials on walls and ceilings.

#### **A.7.8 Cryogenic/oxygen deficiency hazard (LBNF-DUNE HA-8)**

The LBNF/DUNE project will use large volumes of liquid argon, nitrogen, and helium within the FSCF. Cryogenic hazards could include ODH atmospheres due to failure of the cryogenics systems, thermal (cold burn) hazards from cryogenic components, and pressure hazards. Initiators could include the failure or rupture of cryogenics systems from overpressure, failure of insulating vacuum jackets, mechanical damage or failure, deficient maintenance, or improper procedures.

Cryogenic liquids and gases are extremely dangerous to humans. They can destroy tissue and damage materials and equipment past repair by altering characteristics and properties (e.g., size, strength, and flexibility) of metals and other materials.

Although cryogenics are used extensively at Fermilab, quantities that may be used within a facility are strictly limited. Uses beyond defined limits require ODH analyses and using ventilation, ODH monitoring, or other controls.

Cryogenics systems are subject to formal project review, which includes independent reviews by a subpanel of the Cryogenic Safety Subcommittee following National Fire Protection Association Chapter 5032, Cryogenic System Review. The members of this panel have relevant knowledge in

appropriate areas. They review the system safety documentation, ODH analysis documentation, and the equipment before new systems are permitted to begin the cool-down process.

Fermilab has developed and successfully deployed ODH monitoring systems throughout the laboratory to support its current cryogenic operations. The systems provide both local and remote alarms when atmospheres contain less than 19.5% oxygen by volume.

Fermilab has a mature training program to address cryogenic safety hazards. Key program elements include ODH training, pressurized gas safety, and general cryogenic safety.

#### **A.7.9 Confined space hazards (LBNF-DUNE HA-9)**

Hazards from confined spaces could result in death or injury from asphyxiation, compressive asphyxiation, smoke inhalation, or impact with mechanical systems. Initiators would include failure of cryogenics systems that are releasing liquid, gas, or fire, or failure of mechanical systems.

The Fermilab confined-space program is outlined in Fermilab Environmental and Safety Manual Chapter 4230, Confined Spaces. LBNF/DUNE facilities will be incorporated into this program. The emphasis at the LBNF/DUNE design phase will be to create the minimum number of confined spaces by clearly articulating the definition of confined spaces to facility designers to assure that such spaces have adequate egress, that mechanical spaces are adequately sized, and, wherever possible, that no confined space exists at all. During facility operations, the existing campus confined-space program, along with appropriate labeling of confined spaces, work planning and control, and entry permits will be used to control access to these spaces.

#### **A.7.10 Chemical/hazardous materials hazards (LBNF-DUNE HA-11)**

The DUNE facility anticipates minimal use of chemical and hazardous materials. Materials like paints, epoxies, solvents, oils, and lead shielding may be used during construction and operation of the facility. Exposure to these materials could result in injury; exposure could also exceed regulatory limits. Initiators could be experimental operations, transfer of material, failure of packaging, improper marking or labeling, a reactive or explosive event, improper selection of or lack of PPE, or a natural phenomenon.

Fermilab maintains a database of hazardous chemicals in compliance with the requirements imposed by 10 CFR 851 and DOE orders. In addition to an inventory of chemicals at the facility, copies of each manufacturer's safety data sheets (SDS) are maintained. Reviews of conventional safety measures at the facilities show that using these chemicals does not warrant special controls other than appropriate signs, procedures, appropriate use of PPE, and hazard communication training. DUNE will also supply SDS documentation to the SURF ES&H department for all chemicals and hazardous materials that arrive on site.

The industrial hygiene program, detailed in the FESHM 4000 series chapters, addresses potential hazards to workers using such materials. The program identifies how to evaluate workplace hazards when planning work and the controls necessary to either eliminate or mitigate these hazards to an acceptable level.

Specific procedures are also in place for safe handling, storing, transporting, inspecting, and disposing of hazardous materials. These are contained in the FESHM 8000 and 10000 series chapters, Environmental Protection and Material Handling and Transportation, which describe how

to comply with the standards set by the Code of Federal Regulations, Occupational Safety and Health Standards, Hazard Communication, Title 29 CFR, Part 1910.1200.

**A.7.11 Lasers & other non-ionizing radiation hazards (LBNF-DUNE HA-14)**

Production and delivery of Class 3B and Class 4, near-infrared, UV, and visible lasers must be completely contained in transport pipes or designated enclosures for the Class 3B and Class 4 lasers, thus creating a laser controlled area. (This will be in accordance with Fermilab FESHM chapter 4260.) Establishing the laser controlled area prevents areas around it from exceeding the maximum permissible exposure as set by the Fermilab laser safety officer.

**A.7.12 Material handling hazards (LBNF-DUNE HA-15)**

DUNE will require a significant amount of manual and mechanical material handling during the construction, installation, and operations phases. These activities present hazards that include serious injury or death to equipment operators and bystanders, damage to equipment and structures, and interruption of the program. Additional material handling hazards from forklift and tow cart operations include injury to the operator or personnel in the area and contact with equipment or structures. Cranes and hoists will be used during fabrication, testing, removal, and installation of equipment. The error precursors associated with this type of work may include irregularly shaped loads, awkward load attachments, limited space, obscured sight lines, and poor communication. The material or equipment being moved will typically be one of a kind, expensive, or of considerable programmatic value, and without dedicated lifting points or an obvious center of gravity.

Lessons learned from across the DOE complex and OSHA have been evaluated and incorporated into the Fermilab material handling programs documented in the FESHM 10000 series chapters. The laboratory limits personnel with access to mechanical material handling equipment like cranes and forklifts to those who have successfully completed the laboratory's training programs and demonstrated competence in operating this equipment.

**A.7.13 Experimental operations (LBNF-DUNE HA-16)**

Experimental activity undertaken at LBNF/DUNE will be fully reviewed under the operational readiness clearance (ORC) process and by other experts as needed (e.g., representatives from electrical safety, fire safety, environmental compliance, industrial hygiene, cryogenic safety, and industrial safety), to identify and manage the hazards of each experimental operation. The shift leader will ensure that all safety reviews take place for each activity and that any issues are appropriately addressed. The ORC process will document these reviews, covering the necessary controls and management approval to proceed.

Typically, the ORC process evaluates the scope of the proposed experimental activity and identifies the hazards and controls to mitigate them. The process ensures that collaborators are properly trained, that qualified, hazardous material is kept to a minimum, that engineering controls are deployed as a preferred mitigation, and that PPE is appropriate for the hazard.

# Acknowledgments

This document was prepared by the DUNE collaboration using the resources of the Fermi National Accelerator Laboratory (Fermilab), a U.S. Department of Energy, Office of Science, HEP User Facility. Fermilab is managed by Fermi Research Alliance, LLC (FRA), acting under Contract No. DE-AC02-07CH11359.

The DUNE collaboration also acknowledges the international, national, and regional funding agencies supporting the institutions who have contributed to completing this Technical Design Report.

2020 JINST 15 T08009

# Glossary

- Micro Telecommunications Computing Architecture ( $\mu$ TCA)** The computer architecture specification followed by the crates that house charge and light readout electronics in the DP module. 56
- one-pulse-per-second signal (1PPS signal)** An electrical signal with a fast rise time and that arrives in real time with a precise period of one second. 167
- 35 ton prototype** A prototype cryostat and SP detector built at Fermilab before the ProtoDUNE detectors. 59, 60
- 4850L** The depth in feet (1480 m) of the top of the cryostats underground at SURF; used more generally to refer to the DUNE underground area. Called the “4850 level” or “4850L”. 32–35, 43, 47, 50–53, 105, 107
- analog-to-digital converter (ADC)** A sampling of a voltage resulting in a discrete integer count corresponding in some way to the input. 60, 140, 167
- anode plane assembly (APA)** A unit of the SP detector module containing the elements sensitive to ionization in the LAr. It contains two faces each of three planes of wires, and interfaces to the cold electronics and photon detection system. 29, 30, 44, 54, 59, 61, 63, 65–71, 74, 76, 77, 86, 95–98
- ARAPUCA** A PD system design that consists of a light trap that captures wavelength-shifted photons inside boxes with highly reflective internal surfaces until they are eventually detected by SiPM detectors or are lost. 172
- artdaq** A data acquisition toolkit for data transfer, aggregation and processing. 60
- Ash River** The Ash River, Minnesota, USA NOvA experiment far site, used as an assembly test site for DUNE. 23, 28–31, 73, 86
- ASIC** application-specific integrated circuit. 59, 60, 74, 96, 165, 167
- ATLAS** One of two general-purpose detectors at the LHC. It investigates a wide range of physics, from the search for the Higgs boson to extra dimensions and particles that could make up dark matter (DM). 60
- acceptance for use and possession (AUP)** Required for beneficial occupancy of the underground areas at SURF for LBNF and DUNE. 6, 24, 32, 34
- American wire gauge (AWG)** U.S. standard set of non-ferrous wire conductor sizes. 71
- building management system (BMS)** Part of the safety system at SURF that includes the fire and life safety system. 33
- Brookhaven National Laboratory (BNL)** US national laboratory in Upton, NY. 71

- building and site infrastructure (BSI)** The work package for outfitting of the LBNF underground infrastructure. 32
- DAQ control, configuration and monitoring subsystem (CCM)** A system for controlling, configuring and monitoring other systems in particular those that make up the DAQ where the CCM encompasses run control (RC). 99
- cold electronics (CE)** Analog and digital readout electronics that operate at cryogenic temperatures. 74, 97, 98, 140, 167
- European Organization for Nuclear Research (CERN)** The leading particle physics laboratory in Europe and home to the ProtoDUNEs. (In French, the Organisation Européenne pour la Recherche Nucléaire, derived from Conseil Européen pour la Recherche Nucléaire. 10, 28, 86, 100, 101, 103, 166, 168, 170, 172
- conventional facilities (CF)** Pertaining to construction and operation of buildings and conventional infrastructure, and for LBNF/DUNE, CF includes the excavation caverns. 4, 61, 167
- cryogenic instrumentation and slow controls (CISC)** Includes equipment to monitor all detector components and LAr quality and behavior, and provides a control system for many of the detector components. 56, 71
- construction manager/general contractor (CMGC)** The organizational unit responsible for management of the construction of conventional facilities at the underground area at the SURF site. 24, 31
- CMOS** Complementary metal-oxide-semiconductor. 60
- CMP** configuration management plan. 83, 88, 89
- cluster on board (COB)** An ATCA motherboard housing four RCEs. 170
- ColdADC** A newly developed 16-channels ASIC providing analog to digital conversion. 60
- COLDATA** A 64-channel control and communications ASIC. 60, 140
- common fund** The shared resources of the collaboration. 140
- conceptual design review** A project management device by which a conceptual design is reviewed. 78, 79
- cathode plane assembly (CPA)** The component of the SP detector module that provides the drift HV cathode. 30, 54, 63, 65, 66, 68, 74
- charge-parity symmetry violation (CPV)** Lack of symmetry in a system before and after charge and parity transformations are applied. For CP symmetry to hold, a particle turns into its corresponding antiparticle under a charge transformation, and a parity transformation inverts its space coordinates, i.e., produces the mirror image. 111
- charge-readout plane (CRP)** In the DP technology, a collection of electrodes in a planar arrangement placed at a particular voltage relative to some applied E field such that drifting electrons may be collected and their number and time may be measured. 55, 56
- CTS** Cryogenic Test System. 97
- central utility cavern (CUC)** The utility cavern at the 4850L of SURF located between the two detector caverns. It contains utilities such as central cryogenics and other systems, and the underground data center and control room. 8, 24, 25, 33, 35, 37–40, 43, 47, 48, 54, 75

- DAPHNE** Detector electronics for Acquiring PHotons from NEutrinos is a custom-developed warm front-end waveform digitizing electronics module derived from the readout system developed at Fermilab for the Mu2e experiment. 44
- data acquisition (DAQ)** The data acquisition system accepts data from the detector FE electronics, buffers the data, performs a trigger decision, builds events from the selected data and delivers the result to the offline secondary DAQ buffer. 8, 24, 25, 35, 36, 43, 44, 46–51, 53, 54, 56, 60, 75, 79, 91, 99, 100, 165–167, 170
- DUNE detector safety system (DDSS)** The system used to manage key aspects of detector safety. 50–53, 75
- detector module** The entire DUNE far detector is segmented into four modules, each with a nominal 10 kt fiducial mass. 3, 11, 33, 41, 44, 54, 57, 61, 63, 65, 67, 74, 75, 101, 111, 113, 166, 171, 172
- dark matter (DM)** The term given to the unknown matter or force that explains measurements of galaxy motion that are otherwise inconsistent with the amount of mass associated with the observed amount of photon production. 164
- DOE** U.S. Department of Energy. 4, 9, 31, 87, 93, 94, 102, 103, 109, 140, 155, 157–159, 161, 162, 167
- dual-phase (DP)** Distinguishes one of the DUNE far detector technologies by the fact that it operates using argon in both gas and liquid phases. 46, 54–57, 60, 61, 113, 140, 165, 170, 172
- DP module** dual-phase DUNE FD module. 44, 55, 56, 61, 110, 164
- data quality monitoring (DQM)** Analysis of the raw data to monitor the integrity of the data and the performance of the detectors and their electronics. This type of monitoring may be performed in real time, within the DAQ system, or in later stages of processing, using disk files as input. 99, 100
- detector support system (DSS)** The system used to support a SP detector module within its cryostat. 30, 54, 56, 62, 65, 66, 70, 74, 75, 79
- Deep Underground Neutrino Experiment (DUNE)** A leading-edge, international experiment for neutrino science and proton decay studies. 1–25, 27–30, 32, 33, 36, 37, 43, 44, 46–50, 52, 54, 57–59, 61, 71, 73, 75, 77–89, 91–95, 97, 100–114, 139, 140, 155, 158, 161, 162, 164, 166–171
- event builder (EB)** A software agent that executes trigger commands for one detector module by reading out the requested data. 99
- executive board (EB)** The highest level DUNE decision-making body for the collaboration. 5, 11–13, 16–19, 76, 78, 111, 113, 114
- engineering change request (ECR)** The first step in the change control process in which a proposed change is described. 76, 89
- engineering document management system (EDMS)** A computerized document management system developed and supported at CERN in which some DUNE documents, drawings and engineering models are managed. 8, 22, 73, 74, 88, 110, 113
- Experimental Facilities Interface Group (EFIG)** The body responsible for the required high-level coordination between the LBNF and DUNE projects. 5, 8, 19, 78
- endwall field cage (endwall FC)** The vertical portions of the SP FC near the wall. 54, 62
- ERT** emergency response team. 106, 107



- environment, safety and health (ES&H)** A discipline and specialty that studies and implements practical aspects of environmental protection and safety at work. 2, 7, 14–16, 21–23, 80, 83, 87, 94, 102–109, 155, 157, 158, 161
- earned value management system (EVMS)** Earned Value Management is a systematic approach to the integration and measurement of cost, schedule, and technical (scope) accomplishments on a project or task. It provides both the government and contractors the ability to examine detailed schedule information, critical program and technical milestones, and cost data (text from the US DOE); the EVMS is a system that implements this approach. 9
- field cage (FC)** The component of a LArTPC that contains and shapes the applied E field. 54, 55, 63, 65–68, 74, 140, 166, 167
- far detector (FD)** The 70 kt total (40 kt fiducial) mass LArTPC DUNE detector, composed of four 17.5 kt total (10 kt fiducial) mass modules, to be installed at the far site at SURF in Lead, SD, USA. 1, 2, 4, 10, 11, 14, 16–20, 30, 54–57, 59, 61, 73, 166, 168, 169, 171
- front-end (FE)** The front-end refers a point that is “upstream” of the data flow for a particular subsystem. For example the SP front-end electronics is where the cold electronics meet the sense wires of the TPC and the front-end DAQ is where the DAQ meets the output of the electronics. 56, 59, 60, 98, 166, 167, 172
- Front-End Link eXchange (FELIX)** A high-throughput interface between FE and trigger electronics and the standard PCIe computer bus. 60
- front-end mother board (FEMB)** Refers a unit of the SP CE that contains the FE amplifier and ADC ASICs covering 128 channels. 59, 60, 96, 97, 172
- Fermi National Accelerator Laboratory (Fermilab)** U.S. national laboratory in Batavia, IL. It is the laboratory that hosts DUNE and serves as its near site. 4, 5, 7, 10, 13, 21, 28, 31, 47, 80, 97, 102–104, 107–109, 140, 168–170
- Fermilab Environment, Safety and Health Manual (FESHM)** The document that contains Fermilab’s policies and procedures designed to manage environment, safety, and health in all its programs. 102, 103, 105, 158–162
- final design review** A project management device by which a final design is reviewed. 9, 78, 79
- fire and life safety system (FLS)** Part of the safety system at SURF. 33
- field programmable gate array (FPGA)** An integrated circuit technology that allows the hardware to be reconfigured to execute different algorithms after its manufacture and deployment. 170
- Fermi Research Alliance (FRA)** A joint partnership of the University of Chicago and the Universities Research Association (URA) that manages and operates Fermilab on behalf of the DOE. 102
- far site conventional facilities (FSCF)** The CF at the DUNE far detector site, SURF. 6, 7, 14, 44, 47–49, 61, 107, 160, 171
- gaseous argon (GAR)** argon in its gas phase. 33, 38, 39
- ground plane (GP)** An electrode held electrically neutral relative to Earth ground voltage; it is mounted on the FC in a SP module to protect the cryostat wall. 54, 63, 67, 68
- Global Positioning System (GPS)** A satellite-based system that provides a highly accurate one-pulse-per-second signal (1PPS signal) that may be used to synchronize clocks and determine location. 48

- hazard analysis (HA)** A first step in a process to assess risk; the result of hazard analysis is the identification of the hazards present for a task or process. 23, 80, 105, 108, 155, 157
- HAR** hazard analysis report. 155
- high voltage (HV)** Generally describes a voltage applied to drive the motion of free electrons through some media, e.g., LAr. 51, 52, 54, 60, 96, 140
- HVDB** HV divider board. 96
- ICARUS** A neutrino experiment that was located at the Laboratori Nazionali del Gran Sasso (LNGS) in Italy, then refurbished at CERN for re-use in the same neutrino beam from Fermilab used by the MiniBooNE, MicroBooNE and SBND experiments. The ICARUS detector is being reassembled at Fermilab. 58, 60, 77
- ICEBERG R&D cryostat and electronics (ICEBERG)** Integrated Cryostat and Electronics Built for Experimental Research Goals: a new double-walled cryostat built and installed at Fermilab for liquid argon detector R&D and for testing of DUNE detector components. 86
- IESHP** integrated environmental, safety and health plan. 88, 89
- installation readiness review** A project management device by which the plan for installation is reviewed. 23, 78, 80, 105
- integration office** The office that incorporates the onsite team responsible for coordinating integration and installation activities at SURF. 2, 5, 6, 14, 18, 19, 21–25, 49, 65, 71, 78, 79, 82, 110, 168, 170
- Joint Project Office (JPO)** The framework through which team members from the LBNF project office, integration office, and DUNE technical coordination work together to provide coherence in project support functions across the global enterprise. Its functions include global project configuration and integration, installation planning and coordination, scheduling, safety assurance, technical review planning and oversight, development of partner agreements, and financial reporting. 2, 5–10, 14, 17, 18, 61, 62, 65, 71–76, 78, 81, 86, 109–111, 173
- liquid argon (LAr)** Argon in its liquid phase; it is a cryogenic liquid with a boiling point of  $-90^{\circ}\text{C}$  (87 K) and density of 1.4 g/ml. 35–40, 48, 50–52, 54, 56, 65, 70, 74, 77, 96, 97, 165, 172
- liquid argon time-projection chamber (LArTPC)** A TPC filled with liquid argon; the basis for the DUNE FD modules. 1, 54–56, 58, 77, 167
- laser beam location system (LBLS)** Auxiliary calibration system providing an independent location measurement of the ionization laser beams direction. 99
- Long-Baseline Neutrino Committee (LBNC)** The committee, composed of internationally prominent scientists with relevant expertise, charged by the Fermilab director to review the scientific, technical, and managerial progress, plans and decisions associated with DUNE. 79, 81, 111
- LBNE** Long Baseline Neutrino Experiment (a terminated US project that was reformulated in 2014 under the auspices of the new DUNE collaboration, an internationally coordinated and internationally funded program, with Fermilab as host). 58, 77
- Long-Baseline Neutrino Facility (LBNF)** The organizational entity responsible for developing the neutrino beam, the cryostats and cryogenics systems, and the conventional facilities for DUNE. 2, 4–9, 14, 17–19, 21–24, 31–33, 38, 43, 47, 50, 61, 73, 75, 78, 80, 82, 83, 102, 105, 107–111, 113, 139, 165, 166, 169–171

- LBNF and DUNE project (LBNF/DUNE)** The overall global project, including LBNF and DUNE. 2, 4, 5, 7–11, 14, 15, 17–19, 21–25, 31, 82–94, 100–103, 105–109, 111, 155, 157–162, 165
- Long Baseline Neutrino Observatory (LBNO)** A terminated European project that, during its six-year duration, assessed the feasibility of a next-generation deep underground neutrino observatory in Europe). 58, 77
- LED** Light-emitting diode. 98
- large electron multiplier (LEM)** A micro-pattern detector suitable for use in ultra-pure argon vapor; LEMs consist of copper-clad PCB boards with sub-millimeter-size holes through which electrons undergo amplification. 56, 140
- LHC** Large Hadron Collider. 164
- LN<sub>2</sub>** liquid nitrogen. 38, 39, 48, 96, 97
- Monte Carlo (MC)** Refers to a method of numerical integration that entails the statistical sampling of the integrand function. Forms the basis for some types of detector and physics simulations. 139
- main communications room (MCR)** Space at the FD site for cyber infrastructure. 33
- MicroBooNE** The LArTPC-based MicroBooNE neutrino oscillation experiment at Fermilab. 58–60, 77, 168
- MINOS** A long-baseline neutrino experiment, with a near detector at Fermilab and a far detector in the Soudan mine in Minnesota, designed to observe the phenomena of neutrino oscillations (ended data runs in 2012). 10
- memorandum of understanding (MoU)** A document summarizing an agreement between two or more parties. 9, 15, 31
- Mu2e** An experiment sited at Fermilab that searches for charged-lepton flavor violation and seeks to discover physics beyond the standard model (SM). 44
- near detector (ND)** Refers to the detector(s) installed close to the neutrino source at Fermilab. 57
- NOvA** The NOvA off-axis neutrino oscillation experiment at Fermilab. 28, 29, 164
- oxygen deficiency hazard (ODH)** a hazard that occurs when inert gases such as nitrogen, helium, or argon displace room air and thus reduce the percentage of oxygen below the level required for human life. 50, 107, 108, 160, 161
- operational readiness review** A project management device by which the operational readiness is reviewed. 9, 23, 71, 78, 80, 105
- operational readiness clearance (ORC)** Final safety approval prior to the start of operation. 162
- P6** framework used to plan and status the resource-loaded schedule of activities associated with the USA contributions to LBNF and DUNE. 9
- PCB** printed circuit board. 71, 72, 74, 96, 98, 100
- photon detector (PD)** The detector elements involved in measurement of the number and arrival times of optical photons produced in a detector module. 51, 54, 74, 76, 97, 98
- photon detection system (PD system)** The detector subsystem sensitive to light produced in the LAr. 44, 54, 55, 60, 61, 79, 164

- PLC** programmable logic controller. 50–53
- photomultiplier tube (PMT)** A device that makes use of the photoelectric effect to produce an electrical signal from the arrival of optical photons. 56
- personnel protective equipment (PPE)** Equipment worn to minimize exposure to hazards that cause serious workplace injuries and illnesses. 23, 102, 105–107, 159, 161, 162
- preliminary design review** A project management device by which an early design is reviewed. 9, 59, 78, 79
- production progress review** A project management device by which the progress of production is reviewed. 9, 15, 78, 80, 86, 101
- production readiness review** A project management device by which the production readiness is reviewed. 9, 15, 18, 78–80, 100
- project integration director** Responsible for integration and installation of LBNF and DUNE deliverables in South Dakota. Manages the integration office. 2, 5–7, 9, 17, 18, 21–24, 31, 78, 80, 103, 108, 111
- ProtoDUNE** Either of the two DUNE prototype detectors constructed at CERN. One prototype implements SP technology and the other DP. 7, 10, 20, 28, 30, 59, 61, 71, 73, 77, 79–81, 86, 100, 101, 109, 139, 140, 164, 170
- ProtoDUNE-2** The second run of a ProtoDUNE detector. 20, 29, 30, 86
- ProtoDUNE-DP** The DP ProtoDUNE detector at CERN. 60
- ProtoDUNE-SP** The SP ProtoDUNE detector at CERN. 10, 28, 29, 44, 59, 60, 80, 82, 97, 98
- ProtoDUNE-SP-2** A second test run in the single-phase ProtoDUNE test stand at CERN, acting as a validation of the final single-phase detector design. 97–99
- quality assurance (QA)** The set of actions taken to provide confidence that quality requirements are fulfilled, and to detect and correct poor results. 2, 3, 9, 12, 14, 17, 59, 73, 79, 80, 82–89, 92–94, 100, 101, 140, 171
- quality control (QC)** An aggregate of activities (such as design analysis and inspection for defects) performed to ensure adequate quality in manufactured products. 14, 59, 73, 80, 82, 85, 86, 94–98, 100, 140
- resource coordinator (RC)** A member of the DUNE management team responsible for coordinating the financial resources of the project effort. 5, 11
- run control (RC)** The system for configuring, starting and terminating the DAQ. 165
- reconfigurable computing element (RCE)** Data processor located outside of the cryostat on a cluster on board (COB) that contains field programmable gate array (FPGA), RAM and solid-state disk (SSD) resources, responsible for buffering data, producing trigger primitives, responding to triggered requests for data and synching supernova neutrino burst (SNB) dumps. 172
- review office** An office within the integration office that organizes reviews. 78–81, 86, 109
- signal-to-noise (S/N)** signal-to-noise ratio. 113
- SBND** The Short-Baseline Near Detector experiment at Fermilab. 168

- Fermilab South Dakota Services Division (SDSD)** A Fermilab division responsible providing host laboratory functions at SURF in South Dakota. 2, 5, 10, 21, 24, 26, 31, 32, 102, 104
- South Dakota Science and Technology Authority (SDSTA)** The legal entity that manages SURF, in Lead, S.D. 31, 51, 106, 108, 109
- South Dakota Warehouse Facility (SDWF)** Warehousing operations in South Dakota responsible for receiving LBNF and DUNE goods and coordinating shipments to the Ross shaft at SURF. 24, 25, 93, 96, 98
- secondary DAQ buffer** A secondary DAQ buffer holds a small subset of the full rate as selected by a trigger command. This buffer also marks the interface with the DUNE Offline. 166
- signal feedthrough chimney (SFT chimney)** In the DP technology, a volume above the cryostat penetration used for a signal feedthrough. 56
- silicon photomultiplier (SiPM)** A solid-state avalanche photodiode sensitive to single photoelectron signals. 97, 98, 164
- standard model (SM)** Refers to a theory describing the interaction of elementary particles. 169
- supernova neutrino burst (SNB)** A prompt increase in the flux of low-energy neutrinos emitted in the first few seconds of a core-collapse supernova. It can also refer to a trigger command type that may be due to this phenomenon, or detector conditions that mimic its interaction signature. 170
- single-phase (SP)** Distinguishes one of the DUNE far detector technologies by the fact that it operates using argon in its liquid phase only. 3, 54, 57, 59, 61, 113, 164, 166, 167, 170, 172
- SP module** single-phase DUNE FD module. 44, 46, 54–56, 59, 61–70, 72, 96, 110, 111, 113, 167
- solid-state disk (SSD)** Any storage device that may provide sufficient write throughput to receive, both collectively and distributed, the sustained full rate of data from a detector module for many seconds. 170
- SSP** SiPM signal processor. 44
- Sanford Underground Research Facility (SURF)** The laboratory in South Dakota where the LBNF FSCF will be constructed and the DUNE FD will be installed and operated. 2, 5–10, 12, 14, 17, 19, 21, 23, 26, 28, 31–33, 80, 94, 96–99, 101–109, 140, 155, 159, 161, 164, 165, 167, 171, 172
- trip action plan (TAP)** A document required for any trip by a worker to the underground area at SURF, per that site's access control program; it describes the work to be accomplished during the trip. 104
- technical board (TB)** The DUNE organization responsible for evaluating technical decisions. 76, 78, 111
- technical coordinator (TC)** A member of the DUNE management team responsible for organizing the technical aspects of the project effort; is head of technical coordination. 2, 3, 5, 7, 9, 11, 13–15, 17, 18, 71, 73, 75, 78, 80, 83–85, 88, 89, 94, 95, 103, 111, 113
- temporary construction opening (TCO)** An opening in the side of a cryostat through which detector elements are brought into the cryostat; utilized during construction and installation. 30, 37
- technical design report (TDR)** A formal project document that describes the experiment at a technical level. 1, 54, 59, 78, 79, 95, 100, 110, 111, 113, 139
- technical coordination** The DUNE organization responsible for overall integration of the detector elements and successful execution of the detector construction project; areas of responsibility include general project oversight, systems engineering, QA and safety. 2, 5, 6, 12–19, 24, 50, 57, 61, 62, 66, 73–79, 81–83, 86, 87, 89, 93, 94, 110, 111, 139, 140, 168, 171

- time projection chamber (TPC)** A type of particle detector that uses an E field together with a sensitive volume of gas or liquid, e.g., LAr, to perform a 3D reconstruction of a particle trajectory or interaction. The activity is recorded by digitizing the waveforms of current induced on the anode as the distribution of ionization charge passes by or is collected on the electrode. 30, 60, 70, 74, 96–98, 168
- trigger candidate** Summary information derived from the full data stream and representing a contribution toward forming a trigger decision. 172
- trigger command** Information derived from one or more trigger candidates that directs elements of the detector module to read out a portion of the data stream. 166, 171, 172
- trigger decision** The process by which trigger candidates are converted into trigger commands. 166, 172
- concrete encased electrode (Ufer)** U.S. National Electrical Code grounding method referred to as Concrete Encased Electrode. 41–43
- underground installation team (UIT)** An organizational unit responsible for installation in the underground area at the SURF site. 27
- WA105 DP demonstrator** The  $3 \times 1 \times 1 \text{ m}^3$  WA105 DP prototype detector at CERN. 60
- work breakdown structure (WBS)** An organizational project management tool by which the tasks to be performed are partitioned in a hierarchical manner. 57, 58
- warm interface board (WIB)** Digital electronics situated just outside the SP cryostat that receives digital data from the FEMBs over cold copper connections and sends it to the reconfigurable computing element (RCE) FE readout hardware. 54, 172
- warm interface electronics crate (WIEC)** Crates mounted on the signal flanges that contain the WIBs. 54
- wavelength-shifting (WLS)** A material or process by which incident photons are absorbed by a material and photons are emitted at a different, typically longer, wavelength. 172
- X-ARAPUCA** Extended ARAPUCA design with wavelength-shifting (WLS) coating on only the external face of the dichroic filter window(s) but with a WLS doped plate inside the cell. 60

# Bibliography

- [1] J. Fowler, E. McCluskey, A. Heavey and J. Macier, *LBNF/DUNE Configuration Management Plan*, DUNE doc 82, LBNF/DUNE (2019),  
<https://docs.dunescience.org/cgi-bin/ShowDocument?docid=82&asof=2019-11-1>.
- [2] E. Collett and J. Willhite, *Defining Constraints of the Ross Cage Dimensional & Weight Requirements*, DUNE doc 3582, LBNF (2018),  
<https://docs.dunescience.org/cgi-bin/ShowDocument?docid=3582&asof=2019-11-1>.
- [3] T.M. Shaw, *LBNF/DUNE Far Site Detector Grounding System Requirements*, CERN EDMS 2095975, LBNF/DUNE (2019), <https://edms.cern.ch/document/2095975>.
- [4] T.M. Shaw, *Cable Grounding and Shielding Guidelines*, CERN EDMS 2095958, DUNE (2019), <https://edms.cern.ch/document/2095958>.
- [5] J. Fowler Jr., *LBNF 90% Far Site BSI Drawings and Specifications*, CERN EDMS 2093229 LBNF (2019), <https://edms.cern.ch/document/2093229>.
- [6] Kettell, S. et al., *ProtoDUNE Design Review Reports*, DUNE doc 1584, DUNE (2017),  
<https://docs.dunescience.org/cgi-bin/ShowDocument?docid=1584&asof=2019-11-1>.
- [7] F. Feyzi, *DUNE Far Detector Design Review Plan*, DUNE doc 9564, DUNE (2019),  
<https://docs.dunescience.org/cgi-bin/ShowDocument?docid=9564&asof=2019-11-1>.
- [8] S. Kettell and S. Zeller, *JPO Review Office*, DUNE (2019), CERN EDMS 2173197.
- [9] R. Rameika, *ProtoDUNE - SP Lessons Learned*, DUNE doc 8255, DUNE (2018),  
<https://docs.dunescience.org/cgi-bin/ShowDocument?docid=8255&asof=2019-11-1>.
- [10] K. Fahey, *Lessons Learned Guideline*, DUNE doc 8921, DUNE (2018),  
<https://docs.dunescience.org/cgi-bin/ShowDocument?docid=8921>.
- [11] M. Andrews, *Integrated Environment, Safety and Health Management Plan*, DUNE doc 291 (2016),  
<https://docs.dunescience.org/cgi-bin/private/ShowDocument?docid=291&asof=2019-11-1>.
- [12] R. Walton, *Environmental Assessment, FONSI, and Environmental Review Forms*,  
<http://docs.dunescience.org/cgi-bin/ShowDocument?docid=122&asof=2019-11-1>.
- [13] J.D. Cossairt et al., *Planning for safe operations*, in *Fermilab Environment, Safety and Health Manual (FESHM)*, chapters 2001–2110, Fermi National Accelerator Laboratory (2019),  
<https://eshq.fnal.gov/manuals/feshm/#series2000>.
- [14] M. Michels, *ESH Code Equivalency Studies*, Fermilab (2018), FNAL doc 3303.
- [15] Fermilab, *Fermilab Environment, Safety and Health Manual (FESHM)*,  
<http://esh.fnal.gov/xms/FESHM>.

- [16] J. Wilhite, *LBNF BSI - 100 Pct Final Design*, LBNF DocDB 14245, LBNF (2019), <https://docs.dunescience.org/cgi-bin/private/ShowDocument?docid=14245>.
- [17] A. Marchionni, E. Segreto, C. Touramanis and D. Warner, *DUNE Interface Document: SP-APA/PDS*, DUNE doc 6667, DUNE (2018), <https://docs.dunescience.org/cgi-bin/ShowDocument?docid=6667&asof=2019-11-1>.
- [18] D. Christian, A. Marchionni, S. Soldner-Rembold and M. Verzocchi, *DUNE Interface Document: APA/TPC Electronics*, DUNE doc 6670, DUNE (2018), <https://docs.dunescience.org/cgi-bin/ShowDocument?docid=6670&asof=2019-11-1>.
- [19] A. Marchionni, F. Pietropaolo, S. Soldner-Rembold and B. Yu, *DUNE Interface Document: HVS/APA*, DUNE doc 6673, DUNE (2018), <https://docs.dunescience.org/cgi-bin/ShowDocument?docid=6673&asof=2019-11-1>.
- [20] G. Karagiorgi, A. Marchionni, D. Newbold and S. Soldner-Rembold, *DUNEDUNE FD Interface Document: SP APA to Joint DAQ*, DUNE doc 6676, DUNE (2018), <https://docs.dunescience.org/cgi-bin/ShowDocument?docid=6676&asof=2019-11-1>.
- [21] A.C. Villanueva et al., *DUNE FD Interface Document for Single Phase/Joint: SP APA to Joint CISC*, DUNE doc 6679, <http://docs.dunescience.org/cgi-bin/ShowDocument?docid=6679>.
- [22] S. Gollapinni, K. Mahn, A. Marchionni and S. Soldner-Rembold, *DUNE FD Interface Document: Calibration to SP APA*, DUNE doc 7048, DUNE (2018), <https://docs.dunescience.org/cgi-bin/ShowDocument?docid=7048&asof=2019-11-1>.
- [23] A. Marchionni, A. Norman, H. Schellman and S. Soldner-Rembold, *DUNE FD Interface Document: Software and Computing to SP APA*, DUNE doc 7102, DUNE (2018), <https://docs.dunescience.org/cgi-bin/ShowDocument?docid=7102&asof=2019-11-1>.
- [24] D. Christian, E. Segreto, M. Verzocchi and D. Warner, *DUNE Interface Document: Single Phase TPC Cold Electronics and Single Phase TPC Photon System*, DUNE doc 6718, DUNE (2018), <https://docs.dunescience.org/cgi-bin/ShowDocument?docid=6718&asof=2019-11-1>.
- [25] D. Duchesneau, I. Gil-Botella, E. Segreto and D. Warner, *DUNE FD Interface Document: SP Photon Detector to joint High Voltage*, DUNE doc 6721, DUNE (2018), <https://docs.dunescience.org/cgi-bin/ShowDocument?docid=6721&asof=2019-11-1>.
- [26] D. Duchesneau, I. Gil-Botella, G. Karagiorgi and Newbold, *DUNE FD Interface Document: DP Photon Detector to joint DAQ*, DUNE doc 6727, DUNE (2018), <https://docs.dunescience.org/cgi-bin/ShowDocument?docid=6727&asof=2019-11-1>.
- [27] A.C. Villanueva et al., *DUNE FD Interface Document: SP Photon Detector to Joint CISC*, DUNE doc 6730, DUNE (2018), <https://docs.dunescience.org/cgi-bin/ShowDocument?docid=6730&asof=2019-11-1>.
- [28] S. Gollapinni, K. Mahn, E. Segreto and D. Warner, *DUNE FD Interface Document: Calibration to SP Photon Detector*, DUNE doc 7051, DUNE (2018), <https://docs.dunescience.org/cgi-bin/ShowDocument?docid=7051&asof=2019-11-1>.
- [29] A. Norman, H. Schellman, E. Segreto and D. Warner, *DUNE FD Interface Document: Software and Computing to SP Photon Detector*, DUNE doc 7105, DUNE (2018), <https://docs.dunescience.org/cgi-bin/ShowDocument?docid=7105&asof=2019-11-1>.
- [30] D. Christian, F. Pietropaolo, M. Verzocchi and B. Yu, *DUNE Interface Document: Single Phase TPC Cold Electronics and Joint Far Detector HV System*, DUNE doc 6739, DUNE (2018), <https://docs.dunescience.org/cgi-bin/ShowDocument?docid=6739&asof=2019-11-1>.



- [31] D. Christian, G. Karagiorgi, D. Newbold and M. Verzocchi, *DUNE FD Interface Document: SP TPC Electronics to joint DAQ*, DUNE doc 6742, DUNE (2018),  
<https://docs.dunescience.org/cgi-bin/ShowDocument?docid=6742&asof=2019-11-1>.
- [32] A. Cervera Villanueva, D. Christian, S. Gollapinni and M. Verzocchi, *DUNE Interface Document: CISC / SP-TPC Cold Electronics*, DUNE doc 6745, DUNE (2018),  
<https://docs.dunescience.org/cgi-bin/ShowDocument?docid=6745&asof=2019-11-1>.
- [33] D. Christian, S. Gollapinni, K. Mahn and M. Verzocchi, *DUNE Interface Document: Calibration to SP TPC Electronics*, DUNE doc 7054, DUNE (2018),  
<https://docs.dunescience.org/cgi-bin/ShowDocument?docid=7054&asof=2019-11-1>.
- [34] D. Christian, M. Kirby, A. McNab, H. Schellman and M. Verzocchi, *DUNE Interface Document: Software and Computing to SP TPC Electronics*, DUNE doc 7108, DUNE (2018),  
<https://docs.dunescience.org/cgi-bin/ShowDocument?docid=7108&asof=2019-11-1>.
- [35] G. Karagiorgi, D. Newbold, F. Pietropaolo and B. Yu, *DUNE FD Interface Document: High Voltage to DAQ*, DUNE doc 6736, DUNE (2019),  
<https://docs.dunescience.org/cgi-bin/ShowDocument?docid=6736&asof=2019-11-1>.
- [36] A.C. Villanueva et al., *DUNE FD Interface Document: High Voltage to CISC*,  
<https://docs.dunescience.org/cgi-bin/ShowDocument?docid=6787>.
- [37] S. Gollapinni, K. Mahn, F. Pietropaolo and B. Yu, *DUNE FD Interface Document: Calibration to Joint HV*, DUNE doc 7066, DUNE (2018),  
<https://docs.dunescience.org/cgi-bin/ShowDocument?docid=7066&asof=2019-11-1>.
- [38] A. Norman, F. Pietropaolo, H. Schellman and B. Yu, *DUNE FD Interface Document: Software and Computing to Joint HV*, DUNE doc 7120, DUNE (2019),  
<https://docs.dunescience.org/cgi-bin/ShowDocument?docid=7120&asof=2019-11-1>.
- [39] A.C. Villanueva et al., *DUNE FD Interface Document: DAQ to CISC*,  
<https://docs.dunescience.org/cgi-bin/ShowDocument?docid=6790>.
- [40] S. Gollapinni, G. Karagiorgi, K. Mahn and D. Newbold, *DUNE FD Interface Document: Calibration to Joint DAQ*, DUNE doc 7069, DUNE (2018),  
<https://docs.dunescience.org/cgi-bin/ShowDocument?docid=7069&asof=2019-11-1>.
- [41] G. Karagiorgi, D. Newbold, A. Norman and H. Schellman, *DUNE FD Interface Document: Software and Computing to Joint DAQ*, DUNE doc 7123, Columbia, Bristol, Fermilab, and Oregon State (2018), <https://docs.dunescience.org/cgi-bin/ShowDocument?docid=7123&asof=2019-11-1>.
- [42] S. Gollapinni et al., *DUNE FD Interface Document: Calibration to Joint CISC*,  
<https://docs.dunescience.org/cgi-bin/ShowDocument?docid=7072>.
- [43] S. Gollapinni et al., *DUNE FD Interface Document: Software and Computing to Joint CISC*,  
<https://docs.dunescience.org/cgi-bin/ShowDocument?docid=7126>.
- [44] S. Gollapinni, K. Mahn, A. Norman and H. Schellman, *DUNE FD Interface Document: Calibration Task Force to DUNE Software and Computing*, DUNE doc 6868, DUNE (2019),  
<https://docs.dunescience.org/cgi-bin/ShowDocument?docid=6868&asof=2019-11-1>.
- [45] E. James, S. Kettell, A. Marchionni, M. Marshak and S. Soldner-Rembold, *DUNE FD Interface Document: Integration Facility to SP APA*, DUNE doc 6967, DUNE (2019),  
<https://docs.dunescience.org/cgi-bin/ShowDocument?docid=6967&asof=2019-11-1>.
- [46] F. Feyzi, E. James, E. Segreto and T. Shaw, *DUNE FD Interface Document: Facility Interfaces to SP*

- Photon Detection*, DUNE doc 6970, DUNE (2018),  
<https://docs.dunescience.org/cgi-bin/ShowDocument?docid=6970&asof=2019-11-1>.
- [47] D. Christian, F. Feyzi, E. James, T. Shaw and M. Verzocchi, *DUNE Interface Document: Single Phase TPC Cold Electronics and Detector and Facilities Infrastructure (LBNF) and Technical Coordination (DUNE)*, DUNE doc 6973, DUNE (2018),  
<https://docs.dunescience.org/cgi-bin/ShowDocument?docid=6973&asof=2019-11-1>.
- [48] F. Feyzi, E. James, F. Pietropaolo, T. Shaw and B. Yu, *DUNE FD Interface Document: SP TPC Electronics to joint DAQ*, DUNE doc 6985, DUNE (2018),  
<https://docs.dunescience.org/cgi-bin/ShowDocument?docid=6985&asof=2019-11-1>.
- [49] F. Feyzi, E. James, G. Karagiorgi, D. Newbold and T. Shaw, *DUNE FD Interface Document: Facility Interfaces to Joint DAQ*, DUNE doc 6988, DUNE (2018),  
<https://docs.dunescience.org/cgi-bin/ShowDocument?docid=6988&asof=2019-11-1>.
- [50] F. Feyzi et al., *DUNE FD Interface Document: Facility Interfaces to Joint CISC*,  
<https://docs.dunescience.org/cgi-bin/ShowDocument?docid=6991>.
- [51] F. Feyzi, S. Gollapinni, E. James, K. Mahn and T. Shaw, *DUNE FD Interface Document: Facility to Calibration Task Force*, DUNE doc 6829, DUNE (2019),  
<https://docs.dunescience.org/cgi-bin/ShowDocument?docid=6829&asof=2019-11-1>.
- [52] F. Feyzi, E. James, A. Norman, H. Schellman and T. Shaw, *DUNE FD Interface Document: Facility to DUNE Software and Computing*, DUNE doc 6841, DUNE (2019),  
<https://docs.dunescience.org/cgi-bin/ShowDocument?docid=6841&asof=2019-11-1>.
- [53] E. James, S. Kettell, A. Marchionni, M. Marshak and S. Soldner-Rembold, *DUNE FD Interface Document: Integration Facility to SP APA*, DUNE doc 6994, DUNE (2019),  
<https://docs.dunescience.org/cgi-bin/ShowDocument?docid=6994&asof=2019-11-1>.
- [54] E. James, E. Segreto, J. Stewart and D. Warner, *DUNE FD Interface Document: Installation Interfaces to SP Photon Detector*, DUNE doc 6997, DUNE (2018),  
<https://docs.dunescience.org/cgi-bin/ShowDocument?docid=6997&asof=2019-11-1>.
- [55] D. Christian, E. James, S. Kettel, J. Stewart and M. Verzocchi, *DUNE Interface Document: TPC Electronics / Underground Installation Team*, DUNE doc 7000, DUNE (2018),  
<https://docs.dunescience.org/cgi-bin/ShowDocument?docid=7000&asof=2019-11-1>.
- [56] E. James, S. Kettell, F. Pietropaolo, J. Stewart and B. Yu, *DUNE FD Interface Document: Installation Interfaces to Joint HV*, DUNE doc 7012, DUNE (2019),  
<https://docs.dunescience.org/cgi-bin/ShowDocument?docid=7012&asof=2019-11-1>.
- [57] E. James, G. Karagiorgi, S. Kettell, D. Newbold and J. Stewart, *DUNE FD Interface Document: Installation Interfaces to Joint DAQ*, DUNE doc 7015, DUNE (2018),  
<https://docs.dunescience.org/cgi-bin/ShowDocument?docid=7015&asof=2019-11-1>.
- [58] S. Gollapinni et al., *DUNE FD Interface Document: Installation Interfaces to Joint CISC*,  
<https://docs.dunescience.org/cgi-bin/ShowDocument?docid=7018>.
- [59] S. Gollapinni, E. James, K. Mahn and J. Stewart, *DUNE FD Interface Document: Installation to Calibration Task Force*, DUNE doc 6847, DUNE (2019),  
<https://docs.dunescience.org/cgi-bin/ShowDocument?docid=6847&asof=2019-11-1>.
- [60] E. James, A. Norman, H. Schellman and J. Stewart, *DUNE FD Interface Document: Installation to DUNE Software and Computing*, DUNE doc 6853, DUNE (2019),  
<https://docs.dunescience.org/cgi-bin/ShowDocument?docid=6853&asof=2019-11-1>.

- [61] A. Marchionni, R. Patterson, S. Soldner-Rembold and E. Worcester, *DUNE FD Interface Document: DUNE Physics to SP APA*, DUNE doc 7075, DUNE (2018),  
<https://docs.dunescience.org/cgi-bin/ShowDocument?docid=7075&asof=2019-11-1>.
- [62] R. Patterson, E. Segreto, D. Warner and E. Worcester, *DUNE FD Interface Document: DUNE Physics to SP Photon Detector*, DUNE doc 7078, DUNE (2018),  
<https://docs.dunescience.org/cgi-bin/ShowDocument?docid=7078&asof=2019-11-1>.
- [63] D. Christian, R. Patterson, M. Verzocchi and E. Worcester, *DUNE Interface Document: DUNE Physics to SP TPC Electronics*, DUNE doc 7081, DUNE (2018),  
<https://docs.dunescience.org/cgi-bin/ShowDocument?docid=7081&asof=2019-11-1>.
- [64] R. Patterson, F. Pietropaolo, E. Worcester and B. Yu, *DUNE FD Interface Document: DUNE Physics to Joint HV*, DUNE doc 7093, DUNE (2018),  
<https://docs.dunescience.org/cgi-bin/ShowDocument?docid=7093&asof=2019-11-1>.
- [65] G. Karagiorgi, D. Newbold, R. Patterson and E. Worcester, *DUNE FD Interface Document: DUNE Physics to Joint DAQ*, DUNE doc 7096, DUNE (2019),  
<https://docs.dunescience.org/cgi-bin/ShowDocument?docid=7096&asof=2019-11-1>.
- [66] S. Gollapinni et al., *DUNE FD Interface Document: DUNE Physics to Joint CISC*,  
<https://docs.dunescience.org/cgi-bin/ShowDocument?docid=7099&version=1>.
- [67] S. Gollapinni, K. Mahn, R. Patterson and E. Worcester, *DUNE FD Interface Document: Calibration Task Force to DUNE Physics*, DUNE doc 6865, DUNE (2019),  
<https://docs.dunescience.org/cgi-bin/ShowDocument?docid=6865&asof=2019-11-1>.
- [68] S. Gollapinni, K. Mahn, R. Patterson and E. Worcester, *DUNE FD Interface Document: Calibration Task Force to DUNE Physics*, DUNE doc 6871, DUNE (2019),  
<https://docs.dunescience.org/cgi-bin/ShowDocument?docid=6871&asof=2019-11-1>.
- [69] J. Dolph and N. Dhanaraj, *LBNF-DUNE Requirements except Cryostat Requirements*, DUNE doc 112, LBNF/DUNE (2018),  
<https://docs.dunescience.org/cgi-bin/ShowDocument?docid=112&asof=2019-11-1>.
- [70] E. James and S. Kettell, *DUNE FD Risks*, DUNE doc 6443, DUNE (2018),  
<https://docs.dunescience.org/cgi-bin/ShowDocument?docid=6443&asof=2019-11-1>.

# The DUNE collaboration

B. Abi,<sup>1</sup> R. Acciarri,<sup>2</sup> M.A. Acero,<sup>3</sup> G. Adamov,<sup>4</sup> D. Adams,<sup>5</sup> M. Adinolfi,<sup>6</sup> Z. Ahmad,<sup>7</sup> J. Ahmed,<sup>8</sup>  
 T. Alion,<sup>9</sup> S. Alonso Monsalve,<sup>10</sup> C. Alt,<sup>11</sup> J. Anderson,<sup>12</sup> C. Andreopoulos,<sup>14,13</sup> M. Andrews,<sup>2</sup>  
 F. Andrianala,<sup>15</sup> S. Andringa,<sup>16</sup> A. Ankowski,<sup>17</sup> M. Antonova,<sup>18</sup> S. Antusch,<sup>19</sup> A. Aranda-Fernandez,<sup>20</sup>  
 A. Ariga,<sup>21</sup> L.O. Arnold,<sup>22</sup> M.A. Arroyave,<sup>23</sup> J. Asaadi,<sup>24</sup> A. Aurisano,<sup>25</sup> V. Aushev,<sup>26</sup> D. Autiero,<sup>27</sup>  
 F. Azfar,<sup>1</sup> H. Back,<sup>28</sup> J.J. Back,<sup>8</sup> C. Backhouse,<sup>29</sup> P. Baesso,<sup>6</sup> L. Bagby,<sup>2</sup> R. Bajou,<sup>30</sup> S. Balasubramanian,<sup>31</sup>  
 P. Baldi,<sup>32</sup> B. Bambah,<sup>33</sup> F. Barao,<sup>16,34</sup> G. Barenboim,<sup>18</sup> G. Barker,<sup>8</sup> W. Barkhouse,<sup>35</sup> C. Barnes,<sup>36</sup>  
 G. Barr,<sup>1</sup> J. Barranco Monarca,<sup>37</sup> N. Barros,<sup>16,38</sup> J.L. Barrow,<sup>39,2</sup> A. Bashyal,<sup>40</sup> V. Basque,<sup>41</sup> F. Bay,<sup>42</sup>  
 J. Bazo Alba,<sup>43</sup> J.F. Beacom,<sup>44</sup> E. Bechetoille,<sup>27</sup> B. Behera,<sup>45</sup> L. Bellantoni,<sup>2</sup> G. Bellettini,<sup>46</sup> V. Bellini,<sup>48,47</sup>  
 O. Beltramelio,<sup>10</sup> D. Belver,<sup>49</sup> N. Benekos,<sup>10</sup> F. Bento Neves,<sup>16</sup> J. Berger,<sup>50</sup> S. Berkman,<sup>2</sup> P. Bernardini,<sup>51</sup>  
 R.M. Berner,<sup>21</sup> H. Berns,<sup>52</sup> S. Bertolucci,<sup>54,53</sup> M. Betancourt,<sup>2</sup> Y. Bezawada,<sup>52</sup> M. Bhattacharjee,<sup>55</sup>  
 B. Bhuyan,<sup>55</sup> S. Biagi,<sup>56</sup> J. Bian,<sup>32</sup> M. Biassoni,<sup>57</sup> K. Biery,<sup>2</sup> B. Bilki,<sup>58</sup> M. Bishai,<sup>5</sup> A. Bitadze,<sup>41</sup>  
 A. Blake,<sup>59</sup> B. Blanco Siffert,<sup>60</sup> F. Blaszczyk,<sup>2</sup> G. Blazey,<sup>61</sup> E. Blucher,<sup>62</sup> J. Boissevain,<sup>63</sup> S. Bolognesi,<sup>64</sup>  
 T. Bolton,<sup>65</sup> M. Bonesini,<sup>57,66</sup> M. Bongrand,<sup>67</sup> F. Bonini,<sup>5</sup> A. Booth,<sup>9</sup> C. Booth,<sup>68</sup> S. Bordoni,<sup>10</sup>  
 A. Borkum,<sup>9</sup> T. Boschi,<sup>69</sup> N. Bostan,<sup>70</sup> P. Bour,<sup>71</sup> S. Boyd,<sup>8</sup> D. Boyden,<sup>61</sup> J. Bracinek,<sup>72</sup> D. Braga,<sup>2</sup>  
 D. Brailsford,<sup>59</sup> A. Brandt,<sup>24</sup> J. Bremer,<sup>10</sup> C. Brew,<sup>14</sup> E. Brianne,<sup>41</sup> S.J. Brice,<sup>2</sup> C. Brizzolari,<sup>57,66</sup>  
 C. Bromberg,<sup>73</sup> G. Brooijmans,<sup>22</sup> J. Brooke,<sup>6</sup> A. Bross,<sup>2</sup> G. Brunetti,<sup>74</sup> N. Buchanan,<sup>45</sup> H. Budd,<sup>75</sup>  
 D. Caiulo,<sup>27</sup> P. Calafiura,<sup>76</sup> J. Calcutt,<sup>73</sup> M. Calin,<sup>77</sup> S. Calvez,<sup>45</sup> E. Calvo,<sup>49</sup> L. Camilleri,<sup>22</sup> A. Caminata,<sup>78</sup>  
 M. Campanelli,<sup>29</sup> D. Caratelli,<sup>2</sup> G. Carini,<sup>5</sup> B. Carlus,<sup>27</sup> P. Carniti,<sup>57</sup> I. Caro Terrazas,<sup>45</sup> H. Carranza,<sup>24</sup>  
 A. Castillo,<sup>79</sup> C. Castromonte,<sup>80</sup> C. Cattadori,<sup>57</sup> F. Cavalier,<sup>67</sup> F. Cavanna,<sup>2</sup> S. Centro,<sup>74</sup> G. Cerati,<sup>2</sup>  
 A. Cervelli,<sup>54</sup> A. Cervera Villanueva,<sup>18</sup> M. Chalifour,<sup>10</sup> C. Chang,<sup>81</sup> E. Chardonnet,<sup>30</sup> A. Chatterjee,<sup>50</sup>  
 S. Chattopadhyay,<sup>7</sup> J. Chaves,<sup>82</sup> H. Chen,<sup>5</sup> M. Chen,<sup>32</sup> Y. Chen,<sup>21</sup> D. Cherdack,<sup>83</sup> C. Chi,<sup>22</sup> S. Childress,<sup>2</sup>  
 A. Chiriacescu,<sup>77</sup> K. Cho,<sup>84</sup> S. Choubey,<sup>85</sup> A. Christensen,<sup>45</sup> D. Christian,<sup>2</sup> G. Christodoulou,<sup>10</sup>  
 E. Church,<sup>28</sup> P. Clarke,<sup>86</sup> T.E. Coan,<sup>87</sup> A.G. Cocco,<sup>88</sup> J. Coelho,<sup>67</sup> E. Conley,<sup>89</sup> J. Conrad,<sup>90</sup> M. Convery,<sup>17</sup>  
 L. Corwin,<sup>91</sup> P. Cotte,<sup>64</sup> L. Cremaldi,<sup>92</sup> L. Cremonesi,<sup>29</sup> J.I. Crespo-Anadón,<sup>49</sup> E. Cristaldo,<sup>93</sup> R. Cross,<sup>59</sup>  
 C. Cuesta,<sup>49</sup> Y. Cui,<sup>81</sup> D. Cussans,<sup>6</sup> M. Dabrowski,<sup>5</sup> H. Da Motta,<sup>94</sup> L. Da Silva Peres,<sup>60</sup> Q. David,<sup>27</sup>  
 G.S. Davies,<sup>92</sup> S. Davini,<sup>78</sup> J. Dawson,<sup>30</sup> K. De,<sup>24</sup> R.M. De Almeida,<sup>95</sup> P. Debbs,<sup>70</sup> I. De Bonis,<sup>96</sup>  
 M. Decowski,<sup>42,97</sup> A. De Gouvea,<sup>98</sup> P.C. De Holanda,<sup>99</sup> I.L. De Icaza Astiz,<sup>9</sup> A. Deisting,<sup>100</sup>  
 P. De Jong,<sup>42,97</sup> A. Delbart,<sup>64</sup> D. Delepine,<sup>37</sup> M. Delgado,<sup>101</sup> A. Dell'Acqua,<sup>10</sup> P. De Lurgio,<sup>12</sup>  
 J.R. De Mello Neto,<sup>60</sup> D.M. DeMuth,<sup>102</sup> S. Dennis,<sup>103</sup> C. Densham,<sup>14</sup> G. Deptuch,<sup>2</sup> A. De Roeck,<sup>10</sup>  
 V. De Romeri,<sup>18</sup> J. De Vries,<sup>103</sup> R. Dharmapalan,<sup>104</sup> M. Dias,<sup>105</sup> F. Diaz,<sup>43</sup> J. Diaz,<sup>106</sup> S. Di Domizio,<sup>78</sup>  
 L. Di Giulio,<sup>10</sup> P. Ding,<sup>2</sup> L. Di Noto,<sup>78</sup> C. Distefano,<sup>56</sup> R. Diurba,<sup>107</sup> M. Diwan,<sup>5</sup> Z. Djurcic,<sup>12</sup>  
 N. Dokania,<sup>108</sup> M. Dolinski,<sup>109</sup> L. Domine,<sup>17</sup> D. Douglas,<sup>73</sup> F. Drielsma,<sup>17</sup> D. Duchesneau,<sup>96</sup> K. Duffy,<sup>2</sup>  
 P. Dunne,<sup>110</sup> T. Durkin,<sup>14</sup> H. Duyang,<sup>111</sup> O. Dvornikov,<sup>104</sup> D. Dwyer,<sup>76</sup> A. Dyshkant,<sup>61</sup> M. Eads,<sup>61</sup>  
 D. Edmunds,<sup>73</sup> J. Eisch,<sup>112</sup> S. Emery,<sup>64</sup> A. Ereditato,<sup>21</sup> C. Escobar,<sup>2</sup> L. Escudero Sanchez,<sup>103</sup> J.J. Evans,<sup>41</sup>  
 E. Ewart,<sup>106</sup> A.C. Ezeribe,<sup>68</sup> K. Fahey,<sup>2</sup> A. Falcone,<sup>57,66</sup> C. Farnese,<sup>74</sup> Y. Farzan,<sup>113</sup> J. Felix,<sup>37</sup>  
 E. Fernandez-Martinez,<sup>114</sup> P. Fernandez Menendez,<sup>18</sup> F. Ferraro,<sup>78</sup> L. Fields,<sup>2</sup> A. Filkins,<sup>115</sup>  
 F. Filthaut,<sup>42,116</sup> R.S. Fitzpatrick,<sup>36</sup> W. Flanagan,<sup>117</sup> B. Fleming,<sup>31</sup> R. Flight,<sup>75</sup> J. Fowler,<sup>89</sup> W. Fox,<sup>106</sup>  
 J. Franc,<sup>71</sup> K. Francis,<sup>61</sup> D. Franco,<sup>31</sup> J. Freeman,<sup>2</sup> J. Freestone,<sup>41</sup> J. Fried,<sup>5</sup> A. Friedland,<sup>17</sup> S. Fuess,<sup>2</sup>

I. Furic,<sup>118</sup> A.P. Furmanski,<sup>107</sup> A. Gago,<sup>43</sup> H. Gallagher,<sup>119</sup> A. Gallego-Ros,<sup>49</sup> N. Gallice,<sup>121,120</sup>  
V. Galymov,<sup>27</sup> E. Gamberini,<sup>10</sup> T. Gamble,<sup>68</sup> R. Gandhi,<sup>85</sup> R. Gandrajula,<sup>73</sup> S. Gao,<sup>5</sup> D. Garcia-Gamez,<sup>122</sup>  
M.Á. García-Peris,<sup>18</sup> S. Gardiner,<sup>2</sup> D. Gastler,<sup>123</sup> G. Ge,<sup>22</sup> B. Gelli,<sup>99</sup> A. Gendotti,<sup>11</sup> S. Gent,<sup>124</sup>  
Z. Ghorbani-Moghaddam,<sup>78</sup> D. Gibin,<sup>74</sup> I. Gil-Botella,<sup>49</sup> C. Girerd,<sup>27</sup> A. Giri,<sup>125</sup> D. Gnani,<sup>76</sup> O. Gogota,<sup>26</sup>  
M. Gold,<sup>126</sup> S. Gollapinni,<sup>63</sup> K. Gollwitzer,<sup>2</sup> R.A. Gomes,<sup>127</sup> L. Gomez Bermeo,<sup>79</sup> L.S. Gomez Fajardo,<sup>79</sup>  
F. Gonnella,<sup>72</sup> J. Gonzalez-Cuevas,<sup>93</sup> M.C. Goodman,<sup>12</sup> O. Goodwin,<sup>41</sup> S. Goswami,<sup>128</sup> C. Gotti,<sup>57</sup>  
E. Goudzovski,<sup>72</sup> C. Grace,<sup>76</sup> M. Graham,<sup>17</sup> E. Gramellini,<sup>31</sup> R. Gran,<sup>129</sup> E. Granados,<sup>37</sup> A. Grant,<sup>130</sup>  
C. Grant,<sup>123</sup> D. Gratieri,<sup>95</sup> P. Green,<sup>41</sup> S. Green,<sup>103</sup> L. Greenler,<sup>131</sup> M. Greenwood,<sup>40</sup> J. Greer,<sup>6</sup> C. Griffith,<sup>9</sup>  
M. Groh,<sup>106</sup> J. Grudzinski,<sup>12</sup> K. Grzelak,<sup>132</sup> W. Gu,<sup>5</sup> V. Guarino,<sup>12</sup> R. Guenette,<sup>133</sup> A. Guglielmi,<sup>74</sup>  
B. Guo,<sup>111</sup> K. Guthikonda,<sup>134</sup> R. Gutierrez,<sup>101</sup> P. Guzowski,<sup>41</sup> M.M. Guzzo,<sup>99</sup> S. Gwon,<sup>135</sup> A. Habig,<sup>129</sup>  
A. Hackenburg,<sup>31</sup> H. Hadavand,<sup>24</sup> R. Haenni,<sup>21</sup> A. Hahn,<sup>2</sup> J. Haigh,<sup>8</sup> J. Haiston,<sup>91</sup> T. Hamernik,<sup>2</sup>  
P. Hamilton,<sup>110</sup> J. Han,<sup>50</sup> K. Harder,<sup>14</sup> D.A. Harris,<sup>2,136</sup> J. Hartnell,<sup>9</sup> T. Hasegawa,<sup>137</sup> R. Hatcher,<sup>2</sup>  
E. Hazen,<sup>123</sup> A. Heavey,<sup>2</sup> K.M. Heeger,<sup>31</sup> K. Hennessy,<sup>13</sup> S. Henry,<sup>75</sup> M. Hernandez Morquecho,<sup>37</sup>  
K. Herner,<sup>2</sup> L. Hertel,<sup>32</sup> A.S. Hesam,<sup>10</sup> J. Hewes,<sup>25</sup> A. Higuera Pichardo,<sup>83</sup> T. Hill,<sup>138</sup> S.J. Hillier,<sup>72</sup>  
A. Himmel,<sup>2</sup> J. Hoff,<sup>2</sup> C. Hohl,<sup>19</sup> A. Holin,<sup>29</sup> E. Hoppe,<sup>28</sup> G.A. Horton-Smith,<sup>65</sup> M. Hostert,<sup>69</sup>  
A. Hourlier,<sup>90</sup> B. Howard,<sup>106</sup> R. Howell,<sup>75</sup> J. Huang,<sup>139</sup> J. Huang,<sup>52</sup> J. Hugon,<sup>140</sup> G. Iles,<sup>110</sup> A.M. Iliescu,<sup>54</sup>  
R. Illingworth,<sup>2</sup> A. Ioannisian,<sup>141</sup> R. Itay,<sup>17</sup> A. Izmaylov,<sup>18</sup> E. James,<sup>2</sup> B. Jargowsky,<sup>32</sup> F. Jediny,<sup>71</sup>  
C. Jesús-Valls,<sup>142</sup> X. Ji,<sup>5</sup> L. Jiang,<sup>143</sup> S. Jiménez,<sup>49</sup> A. Jipa,<sup>77</sup> A. Joglekar,<sup>81</sup> C. Johnson,<sup>45</sup> R. Johnson,<sup>25</sup>  
B. Jones,<sup>24</sup> S. Jones,<sup>29</sup> C. Jung,<sup>108</sup> T. Junk,<sup>2</sup> Y. Jwa,<sup>22</sup> M. Kabirnezhad,<sup>1</sup> A. Kaboth,<sup>14</sup> I. Kadenko,<sup>26</sup>  
F. Kamiya,<sup>144</sup> G. Karagiorgi,<sup>22</sup> A. Karcher,<sup>76</sup> M. Karolak,<sup>64</sup> Y. Karyotakis,<sup>96</sup> S. Kasai,<sup>145</sup> S.P. Kasetti,<sup>140</sup>  
L. Kashur,<sup>45</sup> N. Kazaryan,<sup>141</sup> E. Kearns,<sup>123</sup> P. Keener,<sup>82</sup> K.J. Kelly,<sup>2</sup> E. Kemp,<sup>99</sup> W. Ketchum,<sup>2</sup> S. Kettell,<sup>5</sup>  
M. Khabibullin,<sup>146</sup> A. Khotjantsev,<sup>146</sup> A. Khvedelidze,<sup>4</sup> D. Kim,<sup>10</sup> B. King,<sup>2</sup> B. Kirby,<sup>5</sup> M. Kirby,<sup>2</sup>  
J. Klein,<sup>82</sup> K. Koehler,<sup>131</sup> L.W. Koerner,<sup>83</sup> S. Kohn,<sup>147,76</sup> P.P. Koller,<sup>21</sup> M. Kordosky,<sup>115</sup> T. Kosc,<sup>27</sup>  
U. Kose,<sup>10</sup> V. Kosteletzky,<sup>106</sup> K. Kothekar,<sup>6</sup> F. Krennrich,<sup>112</sup> I. Kreslo,<sup>21</sup> Y. Kudenko,<sup>146</sup> V. Kudryavtsev,<sup>68</sup>  
S. Kulagin,<sup>146</sup> J. Kumar,<sup>104</sup> R. Kumar,<sup>148</sup> C. Kuruppu,<sup>111</sup> V. Kus,<sup>71</sup> T. Kutter,<sup>140</sup> A. Lambert,<sup>76</sup> K. Lande,<sup>82</sup>  
C.E. Lane,<sup>109</sup> K. Lang,<sup>139</sup> T. Langford,<sup>31</sup> P. Lasorak,<sup>9</sup> D. Last,<sup>82</sup> C. Lastoria,<sup>49</sup> A. Laundrie,<sup>131</sup>  
A. Lawrence,<sup>76</sup> I. Lazanu,<sup>77</sup> R. LaZur,<sup>45</sup> T. Le,<sup>119</sup> J. Learned,<sup>104</sup> P. LeBrun,<sup>27</sup> G. Lehmann Miotto,<sup>10</sup>  
R. Lehnert,<sup>106</sup> M. Leigui de Oliveira,<sup>144</sup> M. Leitner,<sup>76</sup> M. Leyton,<sup>142</sup> L. Li,<sup>32</sup> S. Li,<sup>5</sup> S. Li,<sup>17</sup> T. Li,<sup>86</sup> Y. Li,<sup>5</sup>  
H. Liao,<sup>65</sup> C. Lin,<sup>76</sup> S. Lin,<sup>140</sup> A. Lister,<sup>131</sup> B.R. Littlejohn,<sup>149</sup> J. Liu,<sup>32</sup> S. Lockwitz,<sup>2</sup> T. Loew,<sup>76</sup>  
M. Lokajicek,<sup>150</sup> I. Lomidze,<sup>4</sup> K. Long,<sup>110</sup> K. Loo,<sup>151</sup> D. Lorca,<sup>21</sup> T. Lord,<sup>8</sup> J. LoSecco,<sup>152</sup> W.C. Louis,<sup>63</sup>  
K. Luk,<sup>147,76</sup> X. Luo,<sup>153</sup> N. Lurkin,<sup>72</sup> T. Lux,<sup>142</sup> V.P. Luzio,<sup>144</sup> D. MacFarland,<sup>17</sup> A. Machado,<sup>99</sup>  
P. Machado,<sup>2</sup> C. Macias,<sup>106</sup> J. Macier,<sup>2</sup> A. Maddalena,<sup>154</sup> P. Madigan,<sup>147,76</sup> S. Magill,<sup>12</sup> K. Mahn,<sup>73</sup>  
A. Maio,<sup>16,38</sup> J.A. Maloney,<sup>155</sup> G. Mandrioli,<sup>54</sup> J.C. Maneira,<sup>16,38</sup> L. Manenti,<sup>29</sup> S. Manly,<sup>75</sup> A. Mann,<sup>119</sup>  
K. Manolopoulos,<sup>14</sup> M. Manrique Plata,<sup>106</sup> A. Marchionni,<sup>2</sup> W. Marciano,<sup>5</sup> D. Marfatia,<sup>104</sup> C. Mariani,<sup>143</sup>  
J. Maricic,<sup>104</sup> F. Marinho,<sup>156</sup> A.D. Marino,<sup>157</sup> M. Marshak,<sup>107</sup> C. Marshall,<sup>76</sup> J. Marshall,<sup>8</sup> J. Marteau,<sup>27</sup>  
J. Martin-Albo,<sup>18</sup> N. Martinez,<sup>158</sup> D.A. Martinez Caicedo,<sup>91</sup> S. Martynenko,<sup>108</sup> K. Mason,<sup>119</sup>  
A. Mastbaum,<sup>159</sup> M. Masud,<sup>18</sup> S. Matsuno,<sup>104</sup> J. Matthews,<sup>140</sup> C. Mauger,<sup>82</sup> N. Mauri,<sup>54,53</sup>  
K. Mavrokoridis,<sup>13</sup> R. Mazza,<sup>57</sup> A. Mazzacane,<sup>2</sup> E. Mazzucato,<sup>64</sup> E. McCluskey,<sup>2</sup> N. McConkey,<sup>41</sup>  
K.S. McFarland,<sup>75</sup> C. McGrew,<sup>108</sup> A. McNab,<sup>41</sup> A. Mefodiev,<sup>146</sup> P. Mehta,<sup>160</sup> P. Melas,<sup>161</sup>  
M. Mellinato,<sup>57,66</sup> O. Mena,<sup>18</sup> S. Menary,<sup>136</sup> H. Mendez,<sup>158</sup> A. Menegolli,<sup>162</sup> G. Meng,<sup>74</sup> M. Messier,<sup>106</sup>  
W. Metcalf,<sup>140</sup> M. Mewes,<sup>106</sup> H. Meyer,<sup>163</sup> T. Miao,<sup>2</sup> G. Michna,<sup>124</sup> T. Miedema,<sup>42,116</sup> J. Migenda,<sup>68</sup>  
R. Milincic,<sup>104</sup> W. Miller,<sup>107</sup> J. Mills,<sup>119</sup> C. Milne,<sup>138</sup> O. Mineev,<sup>146</sup> O.G. Miranda,<sup>164</sup> S. Miryala,<sup>5</sup>  
C. Mishra,<sup>2</sup> S. Mishra,<sup>111</sup> A. Mislivec,<sup>107</sup> D. Mladenov,<sup>10</sup> I. Mocioiu,<sup>165</sup> K. Moffat,<sup>69</sup> N. Moggi,<sup>54,53</sup>  
R. Mohanta,<sup>33</sup> T.A. Mohayai,<sup>2</sup> N. Mokhov,<sup>2</sup> J.A. Molina,<sup>93</sup> L. Molina Bueno,<sup>11</sup> A. Montanari,<sup>54</sup>  
C. Montanari,<sup>162</sup> D. Montanari,<sup>2</sup> L.M. Montano Zetina,<sup>164</sup> J. Moon,<sup>90</sup> M. Mooney,<sup>45</sup> A. Moor,<sup>103</sup>  
D. Moreno,<sup>101</sup> B. Morgan,<sup>8</sup> C. Morris,<sup>83</sup> C. Mossey,<sup>2</sup> E. Motuk,<sup>29</sup> C.A. Moura,<sup>144</sup> J. Mousseau,<sup>36</sup> W. Mu,<sup>2</sup>  
L. Mualem,<sup>166</sup> J. Mueller,<sup>45</sup> M. Muether,<sup>163</sup> S. Mufson,<sup>106</sup> F. Muheim,<sup>86</sup> A. Muir,<sup>130</sup> M. Mulhearn,<sup>52</sup>  
H. Muramatsu,<sup>107</sup> S. Murphy,<sup>11</sup> J. Musser,<sup>106</sup> J. Nachtman,<sup>70</sup> S. Nagu,<sup>167</sup> M. Nalbandyan,<sup>141</sup>

R. Nandakumar,<sup>14</sup> D. Naples,<sup>50</sup> S. Narita,<sup>168</sup> D. Navas-Nicolás,<sup>49</sup> N. Nayak,<sup>32</sup> M. Nebot-Guinot,<sup>86</sup> L. Necib,<sup>166</sup> K. Negishi,<sup>168</sup> J.K. Nelson,<sup>115</sup> J. Nesbit,<sup>131</sup> M. Nessi,<sup>10</sup> D. Newbold,<sup>14</sup> M. Newcomer,<sup>82</sup> D. Newhart,<sup>2</sup> R. Nichol,<sup>29</sup> E. Niner,<sup>2</sup> K. Nishimura,<sup>104</sup> A. Norman,<sup>2</sup> R. Northrop,<sup>62</sup> P. Novella,<sup>18</sup> J.A. Nowak,<sup>59</sup> M. Oberling,<sup>12</sup> A. Olivares Del Campo,<sup>69</sup> A. Olivier,<sup>75</sup> Y. Onel,<sup>70</sup> Y. Onishchuk,<sup>26</sup> J. Ott,<sup>32</sup> L. Pagani,<sup>52</sup> S. Pakvasa,<sup>104</sup> O. Palamara,<sup>2</sup> S. Palestini,<sup>10</sup> J.M. Paley,<sup>2</sup> M. Pallavicini,<sup>78</sup> C. Palomares,<sup>49</sup> E. Pantic,<sup>52</sup> V. Paolone,<sup>50</sup> V. Papadimitriou,<sup>2</sup> R. Papaleo,<sup>56</sup> A. Papanestis,<sup>14</sup> S. Paramesvaran,<sup>6</sup> S. Parke,<sup>2</sup> Z. Parsa,<sup>5</sup> M. Parvu,<sup>77</sup> S. Pascoli,<sup>69</sup> L. Pasqualini,<sup>54,53</sup> J. Pasternak,<sup>110</sup> J. Pater,<sup>41</sup> C. Patrick,<sup>29</sup> L. Patrizii,<sup>54</sup> R.B. Patterson,<sup>166</sup> S. Patton,<sup>76</sup> T. Patzak,<sup>30</sup> A. Paudel,<sup>65</sup> B. Paulos,<sup>131</sup> L. Paulucci,<sup>144</sup> Z. Pavlovic,<sup>2</sup> G. Pawloski,<sup>107</sup> D. Payne,<sup>13</sup> V. Pec,<sup>68</sup> S.J. Peeters,<sup>9</sup> Y. Penichot,<sup>64</sup> E. Pennacchio,<sup>27</sup> A. Penzo,<sup>70</sup> O.L. Peres,<sup>99</sup> J. Perry,<sup>86</sup> D. Pershey,<sup>89</sup> G. Pessina,<sup>57</sup> G. Petrillo,<sup>17</sup> C. Petta,<sup>48,47</sup> R. Petti,<sup>111</sup> F. Piastra,<sup>21</sup> L. Pickering,<sup>73</sup> F. Pietropaolo,<sup>10,74</sup> J. Pillow,<sup>8</sup> R. Plunkett,<sup>2</sup> R. Poling,<sup>107</sup> X. Pons,<sup>10</sup> N. Poonthottathil,<sup>112</sup> S. Pordes,<sup>2</sup> M. Potekhin,<sup>5</sup> R. Potenza,<sup>48,47</sup> B.V. Potukuchi,<sup>169</sup> J. Pozimski,<sup>110</sup> M. Pozzato,<sup>54,53</sup> S. Prakash,<sup>99</sup> T. Prakash,<sup>76</sup> S. Prince,<sup>133</sup> G. Prior,<sup>16</sup> D. Pugner,<sup>27</sup> K. Qi,<sup>108</sup> X. Qian,<sup>5</sup> J. Raaf,<sup>2</sup> R. Raboanary,<sup>15</sup> V. Radeka,<sup>5</sup> J. Rademacker,<sup>6</sup> B. Radics,<sup>11</sup> A. Rafique,<sup>12</sup> E. Raguzin,<sup>5</sup> M. Rai,<sup>8</sup> M. Rajaoalisoa,<sup>25</sup> I. Rakhno,<sup>2</sup> H. Rakotondramanana,<sup>15</sup> L. Rakotondravohitra,<sup>15</sup> Y. Ramachers,<sup>8</sup> R. Rameika,<sup>2</sup> M. Ramirez Delgado,<sup>37</sup> B. Ramson,<sup>2</sup> A. Rappoldi,<sup>162</sup> G. Raselli,<sup>162</sup> P. Ratoff,<sup>59</sup> S. Ravat,<sup>10</sup> H. Razafinime,<sup>15</sup> J. Real,<sup>170</sup> B. Rebel,<sup>131,2</sup> D. Redondo,<sup>49</sup> M. Reggiani-Guzzo,<sup>99</sup> T. Rehak,<sup>109</sup> J. Reichenbacher,<sup>91</sup> S.D. Reitzner,<sup>2</sup> A. Renshaw,<sup>83</sup> S. Rescia,<sup>5</sup> F. Resnati,<sup>10</sup> A. Reynolds,<sup>1</sup> G. Riccobene,<sup>56</sup> L.C. Rice,<sup>50</sup> K. Rielage,<sup>63</sup> Y. Rigaut,<sup>11</sup> D. Rivera,<sup>82</sup> L. Rochester,<sup>17</sup> M. Roda,<sup>13</sup> P. Rodrigues,<sup>1</sup> M. Rodriguez Alonso,<sup>10</sup> J. Rodriguez Rondon,<sup>91</sup> A. Roeth,<sup>89</sup> H. Rogers,<sup>45</sup> S. Rosauero-Alcaraz,<sup>114</sup> M. Rossella,<sup>162</sup> J. Rout,<sup>160</sup> S. Roy,<sup>85</sup> A. Rubbia,<sup>11</sup> C. Rubbia,<sup>171</sup> B. Russell,<sup>76</sup> J. Russell,<sup>17</sup> D. Ruterbories,<sup>75</sup> R. Saakyan,<sup>29</sup> S. Sacerdoti,<sup>30</sup> T. Safford,<sup>73</sup> N. Sahu,<sup>125</sup> P. Sala,<sup>121,10</sup> N. Samios,<sup>5</sup> M. Sanchez,<sup>112</sup> D.A. Sanders,<sup>92</sup> D. Sankey,<sup>14</sup> S. Santana,<sup>158</sup> M. Santos-Maldonado,<sup>158</sup> N. Saoulidou,<sup>161</sup> P. Sapienza,<sup>56</sup> C. Sarasty,<sup>25</sup> I. Sarcevic,<sup>172</sup> G. Savage,<sup>2</sup> V. Savinov,<sup>50</sup> A. Scaramelli,<sup>162</sup> A. Scarff,<sup>68</sup> A. Scarpelli,<sup>30</sup> T. Schaffer,<sup>129</sup> H. Schellman,<sup>40,2</sup> P. Schlabach,<sup>2</sup> D. Schmitz,<sup>62</sup> K. Scholberg,<sup>89</sup> A. Schukraft,<sup>2</sup> E. Segreto,<sup>99</sup> J. Sensenig,<sup>82</sup> I. Seong,<sup>32</sup> A. Sergi,<sup>72</sup> F. Sergiampietri,<sup>108</sup> D. Sgalaberna,<sup>11</sup> M. Shaevitz,<sup>22</sup> S. Shafaq,<sup>160</sup> M. Shamma,<sup>81</sup> H.R. Sharma,<sup>169</sup> R. Sharma,<sup>5</sup> T. Shaw,<sup>2</sup> C. Shepherd-Themistocleous,<sup>14</sup> S. Shin,<sup>173</sup> D. Shooltz,<sup>73</sup> R. Shrock,<sup>108</sup> L. Simard,<sup>67</sup> N. Simos,<sup>5</sup> J. Sinclair,<sup>21</sup> G. Sinev,<sup>89</sup> J. Singh,<sup>167</sup> J. Singh,<sup>167</sup> V. Singh,<sup>174,175</sup> R. Sipos,<sup>10</sup> F. Sippach,<sup>22</sup> G. Sirri,<sup>54</sup> A. Sitrika,<sup>91</sup> K. Siyeon,<sup>135</sup> D. Smargianaki,<sup>108</sup> A. Smith,<sup>89</sup> A. Smith,<sup>103</sup> E. Smith,<sup>106</sup> P. Smith,<sup>106</sup> J. Smolik,<sup>71</sup> M. Smy,<sup>32</sup> P. Snopok,<sup>149</sup> M. Soares Nunes,<sup>99</sup> H. Sobel,<sup>32</sup> M. Soderberg,<sup>176</sup> C.J. Solano Salinas,<sup>80</sup> S. Söldner-Rembold,<sup>41</sup> N. Solomey,<sup>163</sup> V. Solovov,<sup>16</sup> W.E. Sondheim,<sup>63</sup> M. Sorel,<sup>18</sup> J. Soto-Oton,<sup>49</sup> A. Sousa,<sup>25</sup> K. Soustruznik,<sup>177</sup> F. Spaggiardi,<sup>1</sup> M. Spanu,<sup>5</sup> J. Spitz,<sup>36</sup> N.J. Spooner,<sup>68</sup> K. Spurgeon,<sup>176</sup> R. Staley,<sup>72</sup> M. Stancari,<sup>2</sup> L. Stanco,<sup>74</sup> H. Steiner,<sup>76</sup> J. Stewart,<sup>5</sup> B. Stillwell,<sup>62</sup> J. Stock,<sup>91</sup> F. Stocker,<sup>10</sup> T. Stokes,<sup>140</sup> M. Strait,<sup>107</sup> T. Strauss,<sup>2</sup> S. Striganov,<sup>2</sup> A. Stuart,<sup>20</sup> D. Summers,<sup>92</sup> A. Surdo,<sup>51</sup> V. Susic,<sup>19</sup> L. Suter,<sup>2</sup> C. Suter,<sup>48,47</sup> R. Svoboda,<sup>52</sup> B. Szczerbinska,<sup>178</sup> A. Szecel,<sup>41</sup> R. Talaga,<sup>12</sup> H. Tanaka,<sup>17</sup> B. Tapia Oregui,<sup>139</sup> A. Tapper,<sup>110</sup> S. Tariq,<sup>2</sup> E. Tatar,<sup>138</sup> R. Tayloe,<sup>106</sup> A. Teklu,<sup>108</sup> M. Tenti,<sup>54</sup> K. Terao,<sup>17</sup> C.A. Ternes,<sup>18</sup> F. Terranova,<sup>57,66</sup> G. Testera,<sup>78</sup> A. Thea,<sup>14</sup> J.L. Thompson,<sup>68</sup> C. Thorn,<sup>5</sup> S. Timm,<sup>2</sup> A. Tonazzo,<sup>30</sup> M. Torti,<sup>57,66</sup> M. Tortola,<sup>18</sup> F. Tortorici,<sup>48,47</sup> D. Totani,<sup>2</sup> M. Touns,<sup>2</sup> C. Touramanis,<sup>13</sup> J. Trevor,<sup>166</sup> W.H. Trzaska,<sup>151</sup> Y.T. Tsai,<sup>17</sup> Z. Tsamalaidze,<sup>4</sup> K. Tsang,<sup>17</sup> N. Tsverava,<sup>4</sup> S. Tufanli,<sup>10</sup> C. Tull,<sup>76</sup> E. Tyley,<sup>68</sup> M. Tzanov,<sup>140</sup> M.A. Uchida,<sup>103</sup> J. Urheim,<sup>106</sup> T. Usher,<sup>17</sup> M. Vagins,<sup>179</sup> P. Vahle,<sup>115</sup> G. Valdivieso,<sup>180</sup> E. Valencia,<sup>115</sup> Z. Vallari,<sup>166</sup> J.W. Valle,<sup>18</sup> S. Vallecorsa,<sup>10</sup> R. Van Berg,<sup>82</sup> R.G. Van de Water,<sup>63</sup> D. Vanegas Forero,<sup>99</sup> F. Varanini,<sup>74</sup> D. Vargas,<sup>142</sup> G. Varner,<sup>104</sup> J. Vassel,<sup>106</sup> G. Vasseur,<sup>64</sup> K. Vaziri,<sup>2</sup> S. Ventura,<sup>74</sup> A. Verdugo,<sup>49</sup> S. Vergani,<sup>103</sup> M.A. Vermeulen,<sup>42</sup> M. Verzocchi,<sup>2</sup> H. Vieira de Souza,<sup>99</sup> C. Vignoli,<sup>154</sup> C. Vilela,<sup>108</sup> B. Viren,<sup>5</sup> T. Vrba,<sup>71</sup> T. Wachala,<sup>181</sup> A.V. Waldron,<sup>110</sup> M. Wallbank,<sup>25</sup> H. Wang,<sup>182</sup> J. Wang,<sup>52</sup> Y. Wang,<sup>182</sup> Y. Wang,<sup>108</sup> K. Warburton,<sup>112</sup> D. Warner,<sup>45</sup> M. Wascko,<sup>110</sup> D. Waters,<sup>29</sup> A. Watson,<sup>72</sup> P. Weatherly,<sup>109</sup> A. Weber,<sup>14,1</sup> M. Weber,<sup>21</sup> H. Wei,<sup>5</sup> A. Weinstein,<sup>112</sup> D. Wenman,<sup>131</sup> M. Wetstein,<sup>112</sup> M.R. White,<sup>91</sup> A. White,<sup>24</sup> L.H. Whitehead,<sup>103</sup> D. Whittington,<sup>176</sup> M.J. Wilking,<sup>108</sup> C. Wilkinson,<sup>21</sup> Z. Williams,<sup>24</sup> F. Wilson,<sup>14</sup>

R.J. Wilson,<sup>45</sup> J. Wolcott,<sup>119</sup> T. Wongjirad,<sup>119</sup> K. Wood,<sup>108</sup> L. Wood,<sup>28</sup> E. Worcester,<sup>5</sup> M. Worcester,<sup>5</sup> C. Wret,<sup>75</sup> W. Wu,<sup>2</sup> W. Wu,<sup>32</sup> Y. Xiao,<sup>32</sup> G. Yang,<sup>108</sup> T. Yang,<sup>2</sup> N. Yershov,<sup>146</sup> K. Yonehara,<sup>2</sup> T. Young,<sup>35</sup> B. Yu,<sup>5</sup> J. Yu,<sup>24</sup> J. Zalesak,<sup>150</sup> L. Zambelli,<sup>96</sup> B. Zamorano,<sup>122</sup> A. Zani,<sup>121</sup> L. Zazueta,<sup>115</sup> G. Zeller,<sup>2</sup> J. Zennamo,<sup>2</sup> K. Zeug,<sup>131</sup> C. Zhang,<sup>5</sup> M. Zhao,<sup>5</sup> E. Zhivun,<sup>5</sup> G. Zhu,<sup>44</sup> E.D. Zimmerman,<sup>157</sup> M. Zito,<sup>64</sup> S. Zucchelli,<sup>54,53</sup> J. Zuklin,<sup>150</sup> V. Zutshi<sup>61</sup> and R. Zwaska<sup>2</sup>

- 1 University of Oxford, Oxford, OX1 3RH, United Kingdom
- 2 Fermi National Accelerator Laboratory, Batavia, IL 60510, USA
- 3 Universidad del Atlantico, Carrera 30 Número 8- 49 Puerto Colombia - Atlántico, Colombia
- 4 Georgian Technical University, 77 Kostava Str. 0160, Tbilisi, Georgia
- 5 Brookhaven National Laboratory, Upton, NY 11973, USA
- 6 University of Bristol, H. H. Wills Physics Laboratory, Tyndall Avenue Bristol BS8 1TL, United Kingdom
- 7 Variable Energy Cyclotron Centre, 1/AF, Bidhannagar Kolkata - 700 064 West Bengal, India
- 8 University of Warwick, Coventry CV4 7AL, United Kingdom
- 9 University of Sussex, Brighton, BN1 9RH, United Kingdom
- 10 CERN, European Organization for Nuclear Research 1211 Genève 23, Switzerland, CERN
- 11 ETH Zurich, Institute for Particle Physics, Zurich, Switzerland
- 12 Argonne National Laboratory, Argonne, IL 60439, USA
- 13 University of Liverpool, L69 7ZE, Liverpool, United Kingdom
- 14 STFC Rutherford Appleton Laboratory, OX11 0QX Harwell Campus, Didcot, United Kingdom
- 15 University of Antananarivo, BP 566, Antananarivo 101, Madagascar
- 16 Laboratório de Instrumentação e Física Experimental de Partículas, Av. Gama Pinto, n.2, Lisboa, Complexo Interdisciplinar (3is) 1649-003 Portugal
- 17 SLAC National Acceleratory Laboratory, Menlo Park, CA 94025, USA
- 18 Instituto de Fisica Corpuscular, Catedratico Jose Beltran, 2 E-46980 Paterna (Valencia), Spain
- 19 University of Basel, Klingelbergstrasse 82, CH-4056 Basel, Switzerland
- 20 Universidad de Colima, 340 Colonia Villa San Sebastian Colima, Colima, Mexico
- 21 University of Bern, Sidlerstrasse 5, CH-3012 Bern, Switzerland
- 22 Columbia University, New York, NY 10027, USA
- 23 Universidad EIA, Via José María Córdoba #km 2 + 200, Envigado, Antioquia
- 24 University of Texas at Arlington, Arlington, TX 76019, USA
- 25 University of Cincinnati, Cincinnati, OH 45221, USA
- 26 Kyiv National University, 64, 01601 Kyiv, Ukraine
- 27 Institut de Physique des 2 Infinis de Lyon, Rue E. Fermi 4 69622 Villeurbanne, France
- 28 Pacific Northwest National Laboratory, Richland, WA 99352, USA
- 29 University College London, London, WC1E 6BT, United Kingdom
- 30 Université de Paris, CNRS, Astroparticule et Cosmologie, F-75006, Paris, France
- 31 Yale University, New Haven, CT 06520, USA
- 32 University of California Irvine, Irvine, CA 92697, USA
- 33 University of Hyderabad, Gachibowli, Hyderabad - 500 046, India
- 34 Instituto Superior Técnico - IST, Univ. de Lisboa, Portugal
- 35 University of North Dakota, 3501 University Ave Grand Forks, ND 58202-8357, USA
- 36 University of Michigan, Ann Arbor, MI 48109, USA
- 37 Universidad de Guanajuato, Gto., C.P. 37000, Mexico
- 38 Faculdade de Ciências - FCUL, Univ. de Lisboa, Portugal
- 39 University of Tennessee at Knoxville, TN, 37996, USA
- 40 Oregon State University, Corvallis, OR 97331, USA
- 41 University of Manchester, Oxford Road, Manchester M13 9PL, United Kingdom
- 42 Nikhef National Institute of Subatomic Physics, Science Park, Amsterdam, Netherlands
- 43 Pontificia Universidad Católica del Perú, Apartado 1761, Lima, Perú
- 44 Ohio State University, 191 W. Woodruff Ave. Columbus, OH 43210, USA
- 45 Colorado State University, Fort Collins, CO 80523, USA

- 46 *Università di Pisa, Theor. Division; Largo B. Pontecorvo 3, Ed. B-C, I-56127 Pisa, Italy*
- 47 *Istituto Nazionale di Fisica Nucleare Sezione di Catania, Via Santa Sofia 64, I-95123 Catania, Italy*
- 48 *Università di Catania, Dipartimento di Fisica e Astronomia "E. Majorana", Italy*
- 49 *CIEMAT, Centro de Investigaciones Energéticas, Medioambientales y Tecnológicas, Av. Complutense, 40, E-28040 Madrid, Spain*
- 50 *University of Pittsburgh, Pittsburgh, PA 15260, USA*
- 51 *Università del Salento and Istituto Nazionale Fisica Nucleare, Via Provinciale per Arnesano, 73100 Lecce, Italy*
- 52 *University of California Davis, Davis, CA 95616, USA*
- 53 *University of Bologna, Department of Physics and Astronomy, viale Berti Pichat 6/2, 40127 Bologna, Italy*
- 54 *Istituto Nazionale di Fisica Nucleare Bologna, 40127 Bologna BO, Italy*
- 55 *Indian Institute of Technology Guwahati, Guwahati, 781 039, India*
- 56 *Laboratori Nazionali del Sud, Via S. Sofia 62, 95123 Catania, Italy*
- 57 *Istituto Nazionale di Fisica Nucleare Sezione di Milano Bicocca, Piazza della Scienza, 3 - I-20126 Milano, Italy*
- 58 *Beykent University, Istanbul*
- 59 *Lancaster University, Bailrigg, Lancaster LA1 4YB, United Kingdom*
- 60 *Universidade Federal do Rio de Janeiro, Rio de Janeiro - RJ, 21941-901, Brazil*
- 61 *Northern Illinois University, Department of Physics, DeKalb, Illinois 60115, USA*
- 62 *University of Chicago, Chicago, IL 60637, USA*
- 63 *Los Alamos National Laboratory, Los Alamos, NM 87545, USA*
- 64 *CEA/Saclay, IRFU Institut de Recherche sur les Lois Fondamentales de l'Univers, F-91191 Gif-sur-Yvette CEDEX, France*
- 65 *Kansas State University, Manhattan, KS 66506, USA*
- 66 *University of Milano-Bicocca, Dep. of Physics "G. Occhialini", Piazza della Scienza 3, Milano, Italy*
- 67 *Laboratoire de l'Accélérateur Linéaire, Bâtiment 200, 91440 Orsay, France*
- 68 *University of Sheffield, Department of Physics and Astronomy, Sheffield S3 7RH, United Kingdom*
- 69 *Durham University, South Road, Durham DH1 3LE, United Kingdom*
- 70 *University of Iowa, Department of Physics and Astronomy 203 Van Allen Hall Iowa City, IA 52242, USA*
- 71 *Czech Technical University in Prague, Břehová 78/7, 115 19 Prague 1, Czech Republic*
- 72 *University of Birmingham, Edgbaston, Birmingham B15 2TT, United Kingdom*
- 73 *Michigan State University, East Lansing, MI 48824, USA*
- 74 *Universtà Degli Studi di Padova, Dip. Fisica e Astronomia G. Galilei and INFN Sezione di Padova, I-35131 Padova, Italy*
- 75 *University of Rochester, Rochester, NY 14627, USA*
- 76 *Lawrence Berkeley National Laboratory, Berkeley, CA 94720, USA*
- 77 *University of Bucharest, Faculty of Physics, Bucharest, Romania*
- 78 *Università degli studi di Genova, Istituto Nazionale di Fisica Nucleare Genova, 16126 Genova GE, Italy*
- 79 *Universidad Sergio Arboleda, Cll 74 -14 -14, 11022 Bogotá, Colombia*
- 80 *Universidad Nacional de Ingeniería, Av. Tupac Amaru 210, Lima 25, Perú*
- 81 *University of California Riverside, 900 University Ave, Riverside CA 92521*
- 82 *University of Pennsylvania, Philadelphia, PA 19104, USA*
- 83 *University of Houston, Houston, TX 77204, USA*
- 84 *Korea Institute of Science and Technology Information, Daejeon, 34141, South Korea*
- 85 *Harish-Chandra Research Institute, Jhansi, Allahabad 211 019, India*
- 86 *University of Edinburgh, Edinburgh EH8 9YL, United Kingdom*
- 87 *Southern Methodist University, Dallas, TX 75275, USA*
- 88 *Istituto Nazionale di Fisica Nucleare Sezione di Napoli, Complesso Universitario di Monte S. Angelo, I-80126 Napoli, Italy*
- 89 *Duke University, Durham, NC 27708, USA*
- 90 *Massachusetts Institute of Technology, Cambridge, MA 02139, USA*
- 91 *South Dakota School of Mines and Technology, Rapid City, SD 57701, USA*
- 92 *University of Mississippi, P.O. Box 1848, University, MS 38677 USA*
- 93 *Universidad Nacional de Asunción, San Lorenzo, Paraguay*



- 94 *Centro Brasileiro de Pesquisas Físicas, Rio de Janeiro, RJ 22290-180, Brazil*
- 95 *Fluminense Federal University, Rua Miguel de Frias, 9 Icaraí Niterói - RJ, 24220-900, Brazil*
- 96 *Laboratoire d'Annecy-le-Vieux de Physique des Particules, CNRS/IN2P3 and Université Savoie Mont Blanc, CNRS/IN2P3 and Université Savoie Mont Blanc, 74941 Annecy-le-Vieux, France*
- 97 *University of Amsterdam, Science Park 105, NL-1098 XG Amsterdam, The Netherlands*
- 98 *Northwestern University, Evanston, IL 60208, USA*
- 99 *Universidade Estadual de Campinas, Campinas - SP, 13083-970, Brazil*
- 100 *Royal Holloway College London, Egham, Surrey, TW20 0EX*
- 101 *Universidad Antonio Nariño, Cra 3 Este No 47A-15, Bogotá, Colombia*
- 102 *Valley City State University, Valley City, ND 58072, USA*
- 103 *University of Cambridge, JJ Thomson Avenue, Cambridge CB3 0HE, United Kingdom*
- 104 *University of Hawaii, Honolulu, HI 96822, USA*
- 105 *São Paulo Federal University, Departamento de Física-Campus Diadema, 09913-030, São Paulo, Brazil*
- 106 *Indiana University, Bloomington, IN 47405, USA*
- 107 *University of Minnesota Twin Cities, Minneapolis, MN 55455, USA*
- 108 *Stony Brook University, SUNY, Stony Brook, New York 11794, USA*
- 109 *Drexel University, Philadelphia, PA 19104, USA*
- 110 *Imperial College of Science Technology and Medicine, Blackett Laboratory Prince Consort Road, London SW7 2BZ, United Kingdom*
- 111 *University of South Carolina, Columbia, SC 29208, USA*
- 112 *Iowa State University, Ames, Iowa 50011, USA*
- 113 *Institute for Research in Fundamental Sciences , Farmanieh St. Tehran, 19538-33511, Iran*
- 114 *Madrid Autonoma University and IFT UAM/CSIC, Ciudad Universitaria de Cantoblanco 28049 Madrid, Spain*
- 115 *College of William and Mary, Williamsburg, VA 23187, USA*
- 116 *Radboud University, Heyendaalseweg 135, NL-6525 AJ Nijmegen, The Netherlands*
- 117 *University of Dallas, Irving, TX 75062-4736, USA*
- 118 *University of Florida, PO Box 118440 Gainesville, FL 32611-8440, USA*
- 119 *Tufts University, Medford, MA 02155, USA*
- 120 *Università degli Studi di Milano, Dipartimento di Fisica, I-20133 Milano, Italy*
- 121 *INFN sezione di Milano, via Celoria 16, 20133 Milano, Italy*
- 122 *University of Granada & CAFPE, Campus Fuentenueva (Edif. Mecenas), 18002 Granada, Spain*
- 123 *Boston University, Boston, MA 02215, USA*
- 124 *South Dakota State University, Brookings, SD 57007, USA*
- 125 *Indian Institute of Technology Hyderabad, Hyderabad, 502285, India*
- 126 *University of New Mexico, 1919 Lomas Blvd. N.E. Albuquerque, NM 87131, USA*
- 127 *Universidade Federal de Goiás, Goiania, GO 74690-900, Brazil*
- 128 *Physical Research Laboratory, Ahmedabad 380 009, India*
- 129 *University of Minnesota Duluth, Duluth, MN 55812, USA*
- 130 *Daresbury Laboratory, Daresbury Warrington, Cheshire WA4 4AD, United Kingdom*
- 131 *University of Wisconsin Madison, Madison, WI 53706, USA*
- 132 *University of Warsaw, Faculty of Physics ul. Pasteura 5 02-093 Warsaw, Poland*
- 133 *Harvard University, 17 Oxford St. Cambridge, MA 02138, USA*
- 134 *K L University, K L E F, Green Fields, Guntur - 522 502, AP, India*
- 135 *Chung-Ang University, Dongjak-Gu, Seoul 06974, South Korea*
- 136 *York University, Physics and Astronomy Department, 4700 Keele St. Toronto M3J 1P3, Canada*
- 137 *High Energy Accelerator Research Organization (KEK), Ibaraki, 305-0801, Japan*
- 138 *Idaho State University, Department of Physics, Pocatello, ID 83209, USA*
- 139 *University of Texas at Austin, Austin, TX 78712, USA*
- 140 *Louisiana State University, Baton Rouge, LA 70803, USA*
- 141 *Yerevan Institute for Theoretical Physics and Modeling, Halabian Str. 34, Yerevan 0036, Armenia*
- 142 *Institut de Física d'Altes Energies , Campus UAB, Facultat Ciències Nord, 08193 Bellaterra, Barcelona, Spain*
- 143 *Virginia Tech, Blacksburg, VA 24060, USA*

- 144 *Universidade Federal do ABC, Av. dos Estados 5001, Santo André - SP, 09210-580 Brazil*
- 145 *National Institute of Technology, Kure College, Kure College, Hiroshima, 737-8506, Japan*
- 146 *Institute for Nuclear Research of the Russian Academy of Sciences, prospekt 60-letiya Oktyabrya 7a, Moscow 117312, Russia*
- 147 *University of California Berkeley, Berkeley, CA 94720, USA*
- 148 *Punjab Agricultural University, Department of Math. Stat. & Physics, Ludhiana 141004, India*
- 149 *Illinois Institute of Technology, Chicago, IL 60616, USA*
- 150 *Institute of Physics, Czech Academy of Sciences, Na Slovance 2, 182 21 Praha 8, Czech Republic*
- 151 *University of Jyväskylä, P.O. Box 35, FI-40014, Finland*
- 152 *University of Notre Dame, Notre Dame, IN 46556, USA*
- 153 *University of California Santa Barbara, Santa Barbara, California 93106 USA*
- 154 *Laboratori Nazionali del Gran Sasso, I-67010 Assergi, AQ, Italy*
- 155 *Dakota State University, Madison, SD 57042, USA*
- 156 *Universidade Federal de São Carlos, Araras - SP, 13604-900, Brazil*
- 157 *University of Colorado Boulder, Boulder, CO 80309, USA*
- 158 *University of Puerto Rico, Mayaguez, 00681, USA*
- 159 *Rutgers University, Piscataway, NJ, 08854, USA*
- 160 *Jawaharlal Nehru University, School of Physical Sciences, New Delhi 110067, India*
- 161 *University of Athens, University Campus, Zografou GR 157 84, Greece*
- 162 *Università degli studi di Pavia, Istituto Nazionale di Fisica Nucleare Sezione di Pavia, I-27100 Pavia, Italy*
- 163 *Wichita State University, Physics Division, Wichita, KS 67260, USA*
- 164 *Centro de Investigacion y de Estudios Avanzados del IPN (Cinvestav), Mexico City*
- 165 *Pennsylvania State University, University Park, PA 16802, USA*
- 166 *California Institute of Technology, Pasadena, CA 91125, USA*
- 167 *University of Lucknow, Lucknow 226007, Uttar Pradesh, India*
- 168 *Iwate University, Morioka, Iwate 020-8551, Japan*
- 169 *University of Jammu, Physics Department, JAMMU-180006, India*
- 170 *University Grenoble Alpes, CNRS, Grenoble INP, LPSC-IN2P3, 38000 Grenoble, France*
- 171 *Gran Sasso Science Institute, Viale Francesco Crispi 7, L'Aquila, Italy*
- 172 *University of Arizona, 1118 E. Fourth Street Tucson, AZ 85721, USA*
- 173 *Jeonbuk National University, 414, Natural Science Building #5 Department of Physics 567 Baekjedaero, Deogjin-gu Jeonju, Jeonrabuk-do 54896*
- 174 *Central University of South Bihar, Department of Physics SH-7, Gaya Panchanpur Road, Gaya - 824236*
- 175 *Banaras Hindu University, Department of Physics, Varanasi - 221 005, India*
- 176 *Syracuse University, Syracuse, NY 13244, USA*
- 177 *Institute of Particle and Nuclear Physics of the Faculty of Mathematics and Physics of the Charles University in Prague, V Holešovičkách 747/2, 180 00 Praha 8-Libeň, Czech Republic*
- 178 *Texas A&M University (Corpus Christi), Corpus Christi, TX 78412, USA*
- 179 *Kavli Institute for the Physics and Mathematics of the Universe, Kashiwa, Chiba 277-8583, Japan*
- 180 *Universidade Federal de Alfenas, Poços de Caldas - MG, 37715-400, Brazil*
- 181 *H. Niewodniczański Institute of Nuclear Physics, Polish Academy of Sciences, Cracow, Poland*
- 182 *University of California Los Angeles, Los Angeles, CA 90095, USA*